

ASSEMBLY INSTRUCTIONS

Description : FULL BED

Thank you for purchasing this quality product. Be sure to check all packing material carefully for small part that may have come loose inside carton during shipment.

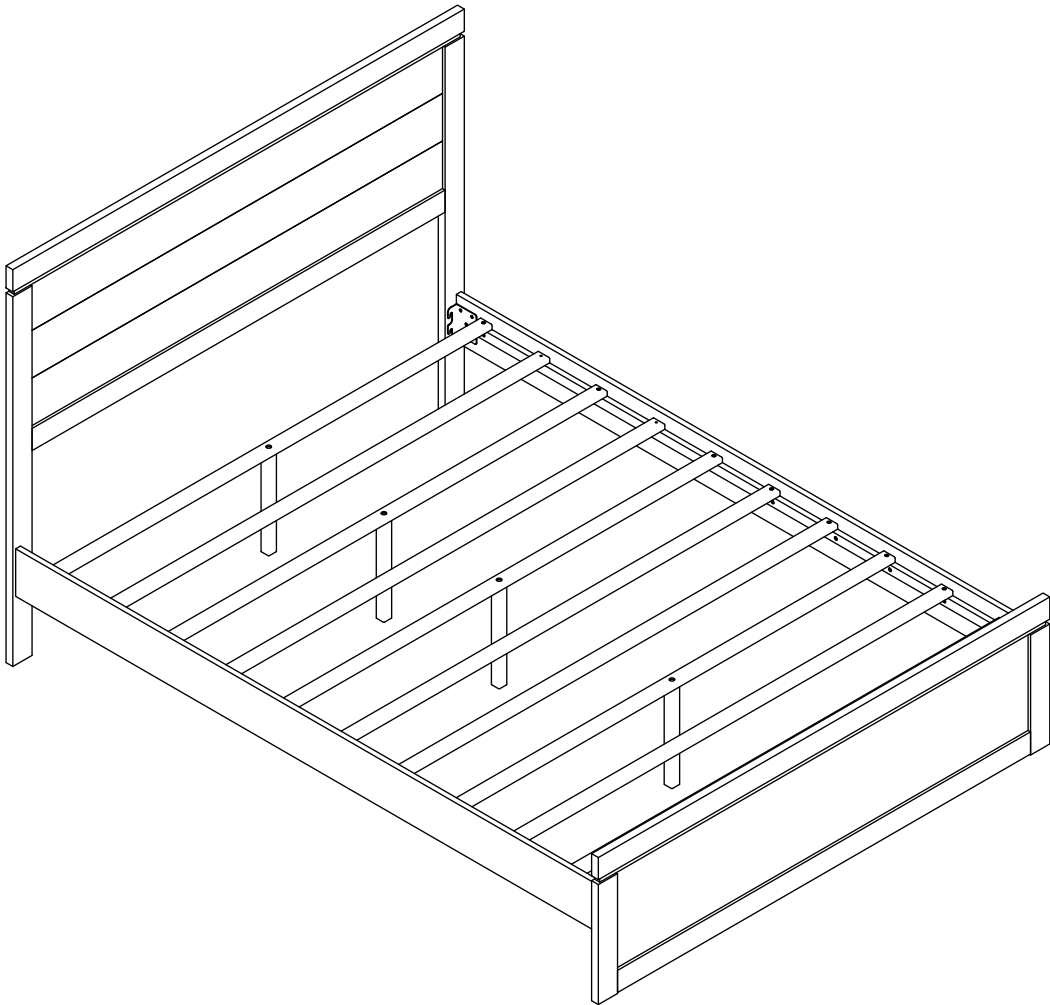

ASSEMBLY INSTRUCTIONS
Description : FULL BED



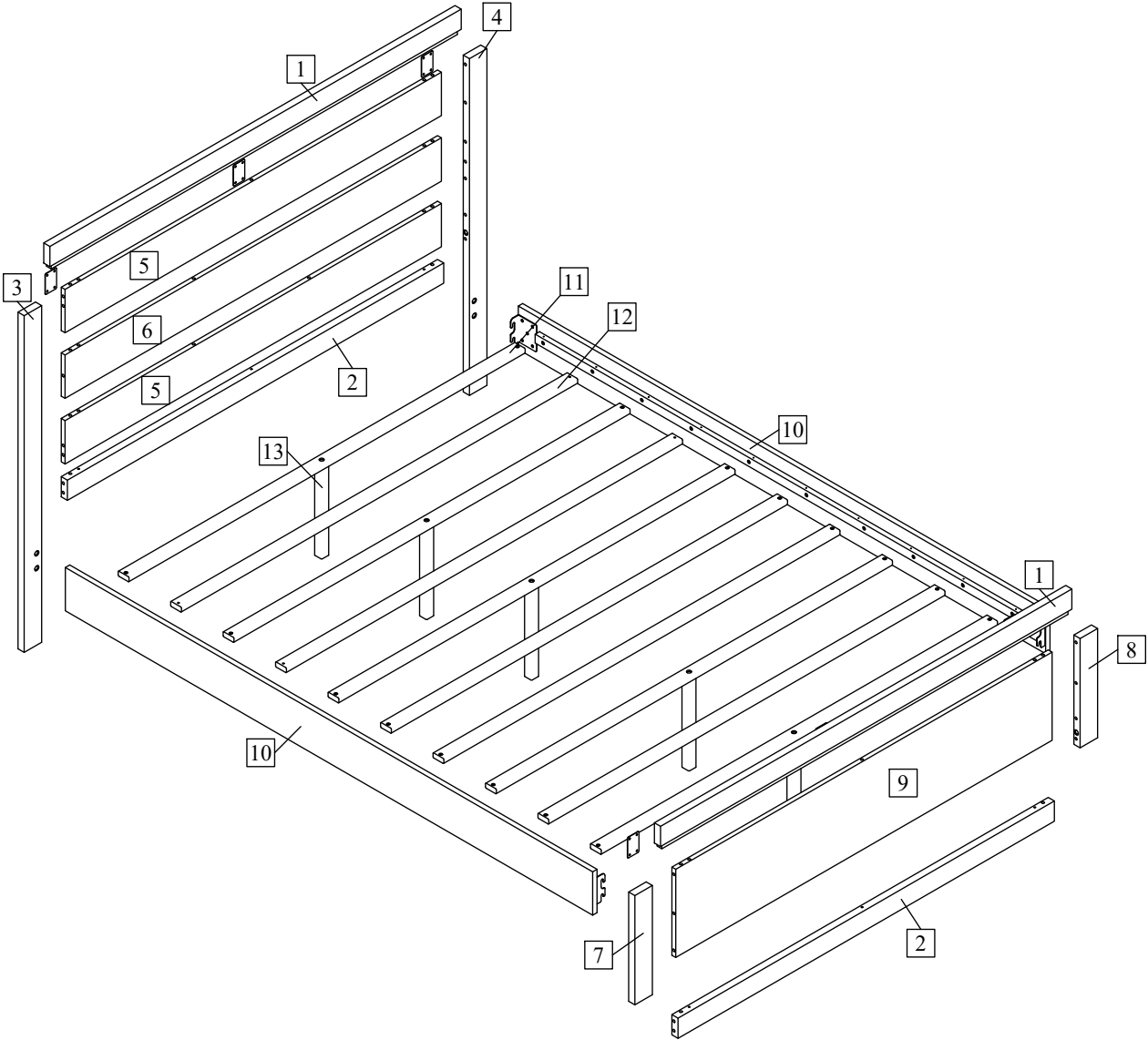







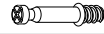

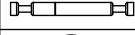

















Thank you for purchasing this quality product. Be sure to check all packing material carefully for small part that may have come loose inside carton during shipment.

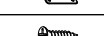

ASSEMBLY INSTRUCTIONS

Description : FULL BED

Thank you for purchasing this quality product. Be sure to check all packing material carefully for small part that may have come loose inside carton during shipment.

Part List				Hardware List			
No.	Description	Sketch	Quantity	No.	Description	Sketch	Quantity
1	Top Rail		2PCS	A	Minifix Bolt		12PCS
2	Bottom Rail		2PCS	B	Minifix Bolt (Double Head)		8PCS
3	Headboard - Leg Left		1PC	C	Minifix Cam		28PCS
4	Headboard - Leg Right		1PC	D	Wood Dowel M8 x 30mm		38PCS
5	Headboard - Top & Btm. Panel		2PCS	E	Panhead Screw M4 x 30mm		20PCS
6	Headboard - Center Panel		1PC	F	C100 Plastic Nail		4PCS
7	Footboard - Leg Left		1PC	G	JCBB M8 x 20mm		8PCS
8	Footboard - Leg Right		1PC	H	Flat Washer M8		8PCS
9	Footboard - Center Panel		1PC	I	Allen Key M5		1PC
10	Side Rail		2PCS	J	JCBC M6 x 50mm		9PCS
11	Slat - 1		5PCS	K	Adjustable Glider		5PCS
12	Slat - 2		5PCS	L	Allen Key M4		1PC
13	Vertical Leg		5PCS	M	Bed Bracket L/R		2 SETS
TOOLS REQUIRED (Not provided)				N	4H Metal Plate		6PCS
 Screwdriver				O	CSK Screw M3.5 x 16mm		44PCS
				P	Spring Washer M6		4PCS
				Q	Flat Washer M6 x 13mm		4PCS





ASSEMBLY INSTRUCTIONS

Description : FULL BED

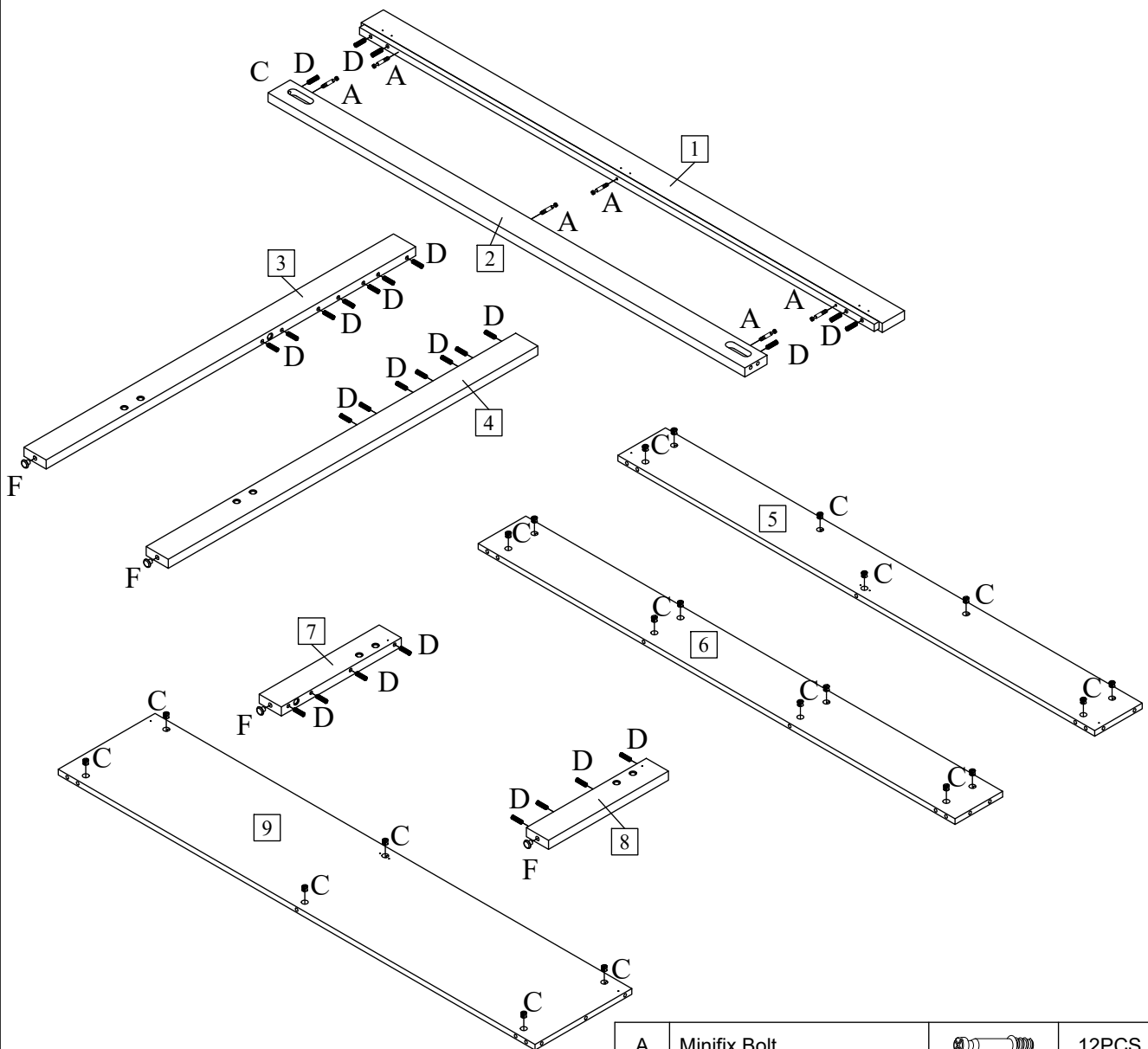
Thank you for purchasing this quality product. Be sure to check all packing material carefully for small part that may have come loose inside carton during shipment.

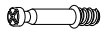
Step 1 : Attach Minifix Bolt (A), Minifix Cam (C) and Wood Dowel (D) to Top Rail (1), Btm. Rail (2), Headboard - Leg Left (3), Leg Right (4), Headboard - Top & Btm. Panel (5), Headboard - Center Panel (6), Footboard - Leg Left (7), Leg Right (8) and Footboard - Canter Panel (9). Attach C100 Plastic Nail (F) to Headboard - Leg Left (3), Leg Right (4), Footboard - Leg Left (7), Leg Right (8).



A	Minifix Bolt		12PCS
C	Minifix Cam		28PCS
D	Wood Dowel M8 x 30mm		34PCS
F	C100 Plastic Nail		4PCS

ASSEMBLY INSTRUCTIONS



Description : FULL BED

Thank you for purchasing this quality product. Be sure to check all packing material carefully for small part that may have come loose inside carton during shipment.

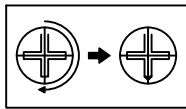
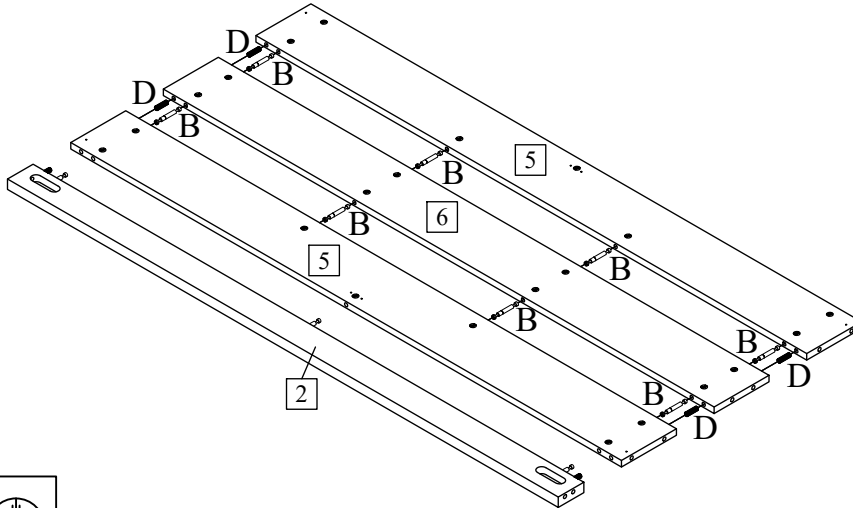
Step 2 : Assembly Btm. Rail (2), Headboard - Top & Btm. Panel (5), Headboard - Center Panel (6) by using Minifix Bolt (Double Head) (B) and Wood Dowel (D).







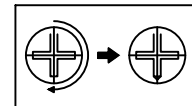
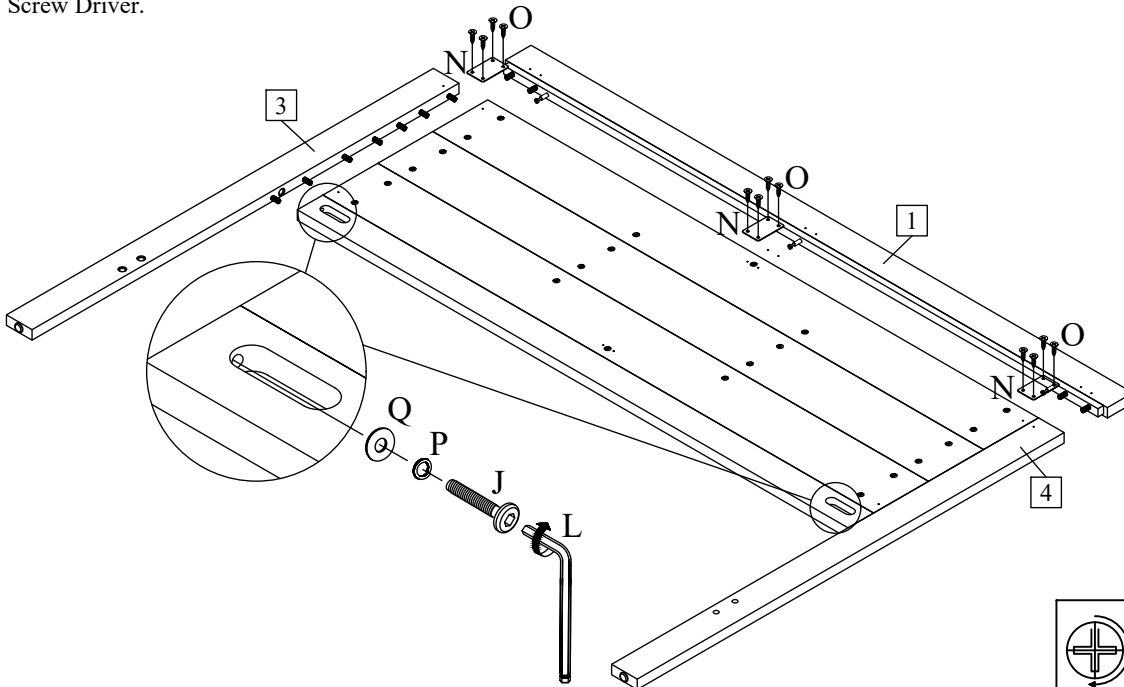

Lock Minifix Cam clockwise

B	Minifix Bolt (Double Head)		8PCS
D	Wood Dowel M8 x 30mm		4PCS

Step 3 : Attach Headboard - Leg Left (3), Leg Right (4), by using Allen Key M4 (L) to tighten JCBC (J), Spring Washer (P) and Flat Washer (Q). Assembly Top Rail (1), after that attach 4H Metal Plate (N) by using CSK Screw M3.5 x 16mm (O), tighten with Screw Driver.



Lock Minifix Cam clockwise

J	JCBC M6 x 50mm		2PCS	Q	Flat Washer M6 x 13mm		2PCS
L	Allen Key M4		1PC	N	4H Metal Plate		3PCS
P	Spring Washer M6		2PCS	O	CSK Screw M3.5 x 16mm		12PCS

ASSEMBLY INSTRUCTIONS

Description : FULL BED

Thank you for purchasing this quality product. Be sure to check all packing material carefully for small part that may have come loose inside carton during shipment.

Step 4 : Assembly Btm. Rail (2), and Footboard - Center Panel (9).

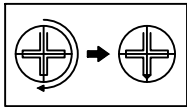
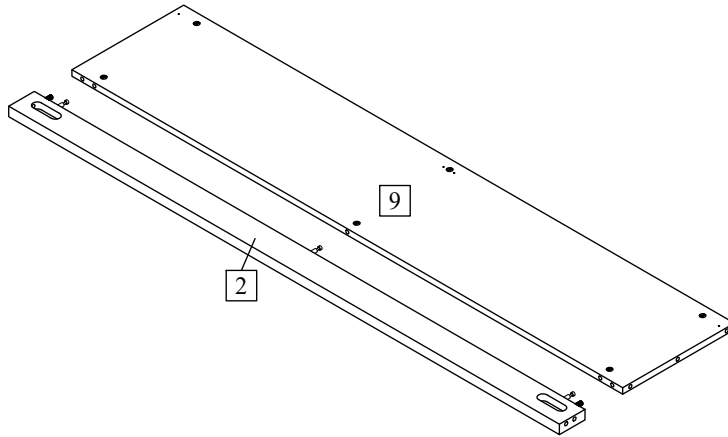

Lock Minifix Cam clockwise

Step 5 : Attach Footboard - Leg Left (7), Leg Right (8) by using Allen Key M4 (L) to tighten JCBC (J), Spring Washer (P) and Flat Washer (Q). Assembly Top Rail (1), after that attach 4H Metal Plate (N) by using CSK Screw M3.5 x 16mm (O), tighten with Screw Driver.

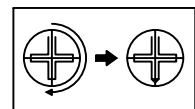
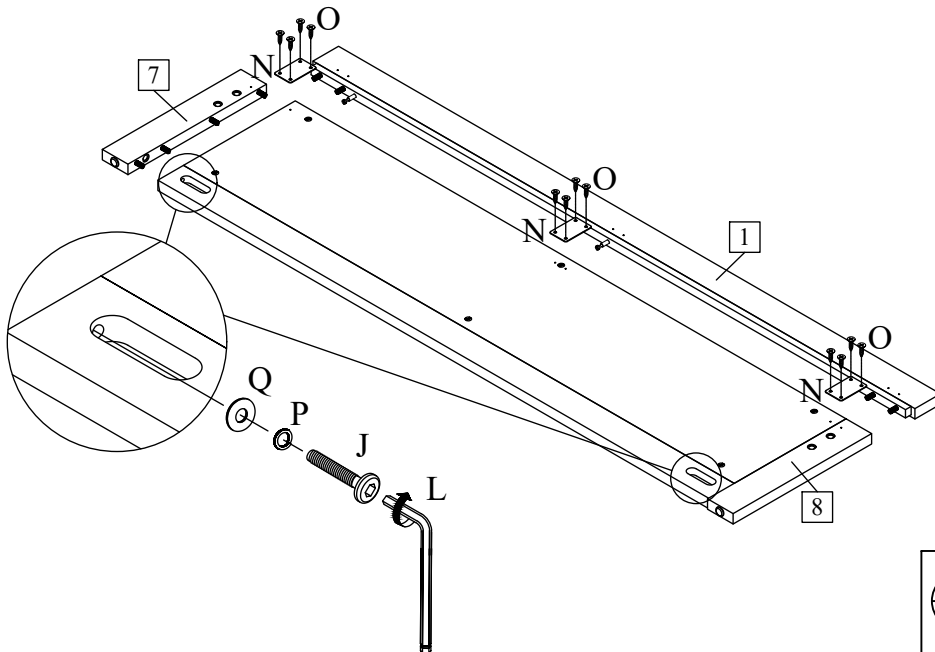

Lock Minifix Cam clockwise

J	JCBC M6 x 50mm		2PCS	Q	Flat Washer M6 x 13mm		2PCS
L	Allen Key M4		1PC	N	4H Metal Plate		3PCS
P	Spring Washer M6		2PCS	O	CSK Screw M3.5 x 16mm		12PCS

ASSEMBLY INSTRUCTIONS

Description : FULL BED

Thank you for purchasing this quality product. Be sure to check all packing material carefully for small part that may have come loose inside carton during shipment.

Step 6 : Attach Bed Bracket L/R (M) to Side Rail (10) by using CSK Screw M3.5 x 16mm (O) and tighten with Screw Driver.

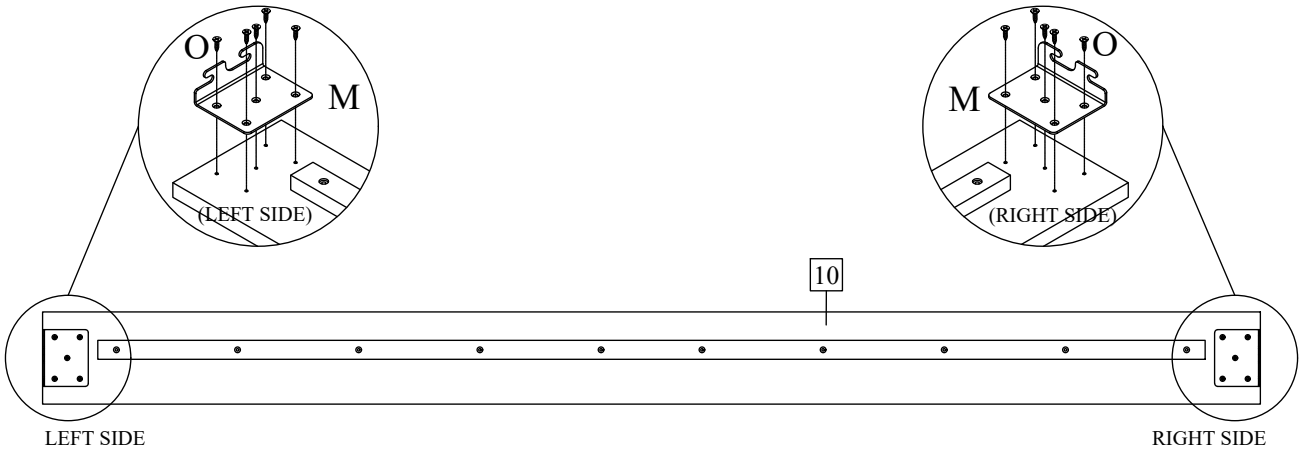

M	Bed Bracket L/R		2 SETS
O	CSK Screw M3.5 x 16mm		20PCS

Step 7 : Attach Side Rail (10) to Headboard and Footboard. Insert Flat Washer M8 (H) to JCBB (G) and tighten by Allen Key M5 (I).

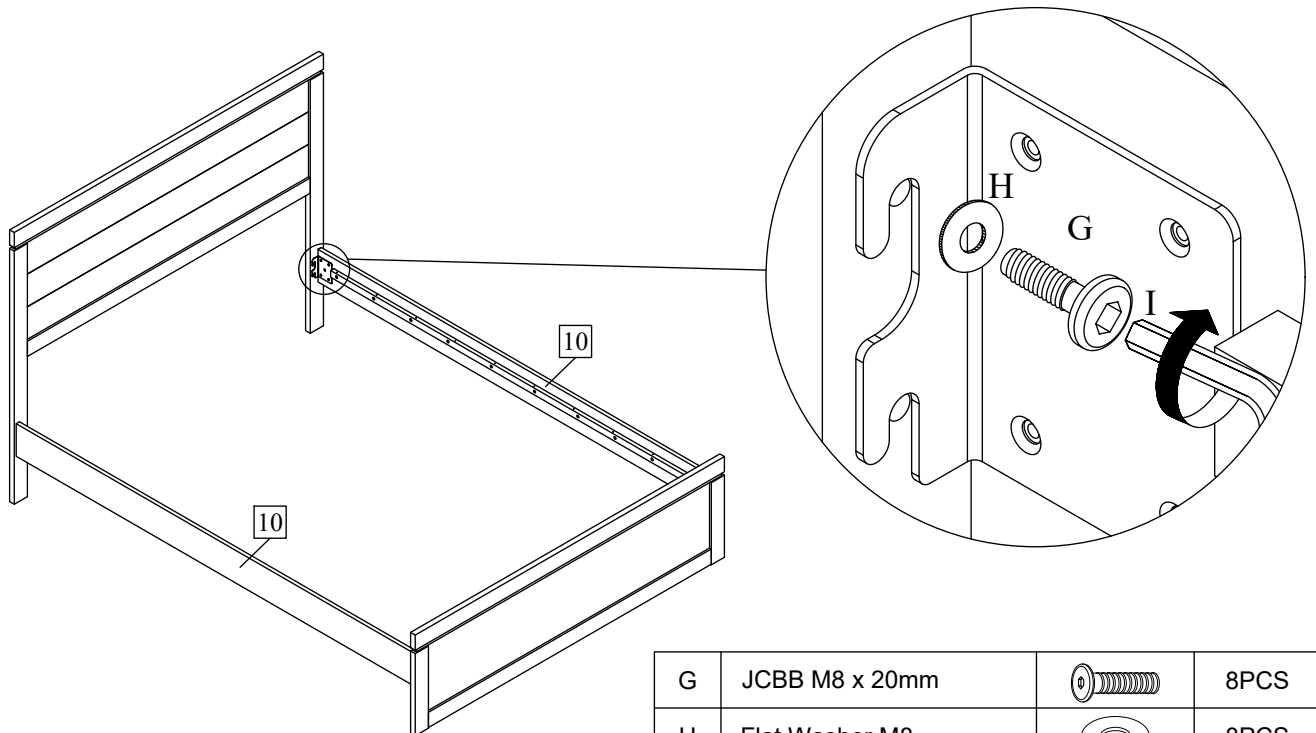

G	JCBB M8 x 20mm		8PCS
H	Flat Washer M8		8PCS
I	Allen Key M5		1PC

ASSEMBLY INSTRUCTIONS

Description : FULL BED

Thank you for purchasing this quality product. Be sure to check all packing material carefully for small part that may have come loose inside carton during shipment.

Step 8 : Attach Adjustable Glider (K) to Vertical Leg (13).

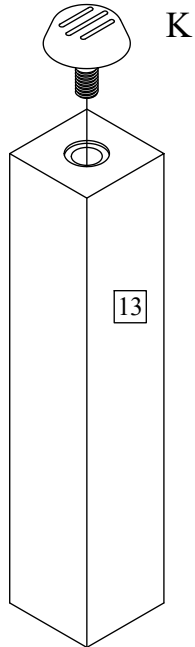

K	Adjustable Glider		5PCS
---	-------------------	--	------

Step 9 : Attach Slat - 1 (11) and Slat - 2 (12) to Side Rail (10) by follow marking, use Panhead Screw M4 x 30mm (E) tighten with Screw Driver. Attach Vertical Leg (13) to Slat - 1 (11) using JCBC (J) and tighten by Allen Key M4 (L).

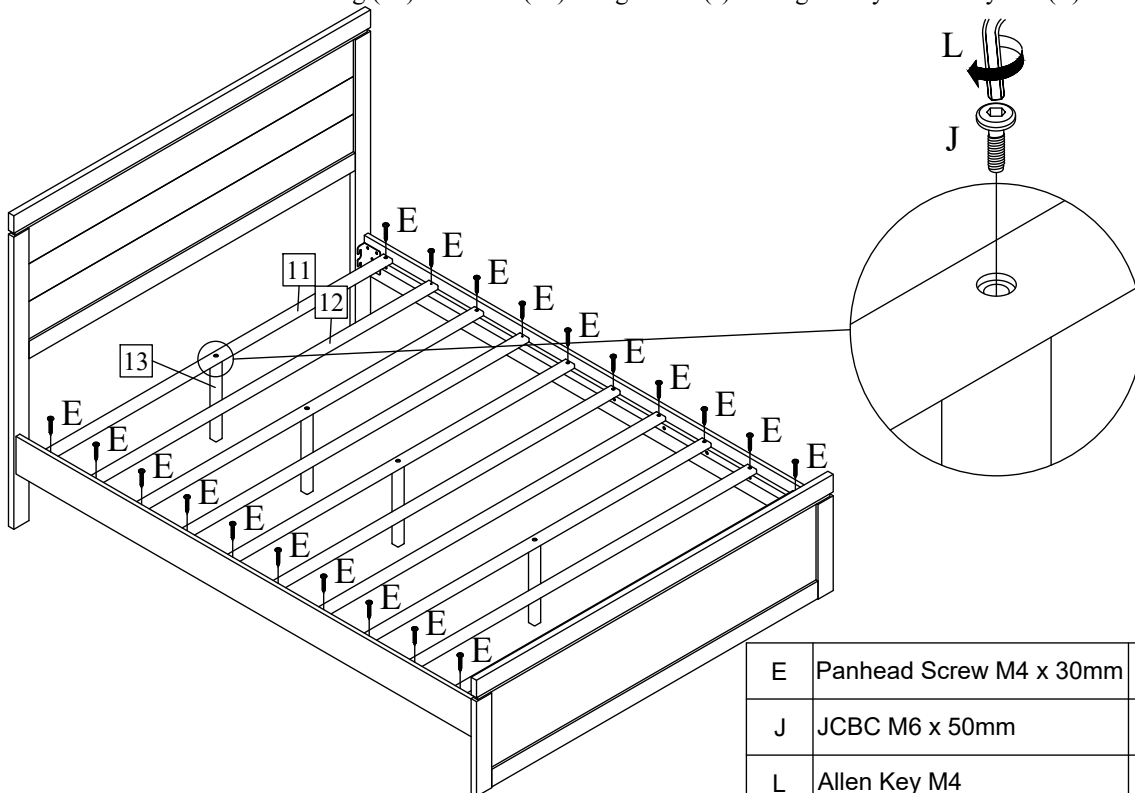

E	Panhead Screw M4 x 30mm		20PCS
J	JCBC M6 x 50mm		5PCS
L	Allen Key M4		1PC