

⚠ WARNING

This is not a toy and is intended for use by or under the supervision of adults. Darts should only be thrown at the dart board. Ensure the flight path is clear of people or pets when playing this game. Impact from darts could cause physical harm, injury or property damage. Don't throw damaged darts.

OWNER'S MANUAL

1. Read this manual carefully before starting assembly. Read each step completely before beginning each step.
2. Check inside all parts and cartons before assembling or ordering parts.
3. To make assembly as easy as possible, place all parts in a cleared area and remove the packaging material. Organize all parts as per parts identifier in the assembly manual. Do not dispose of the packing material until assembly is completed.
4. Avoid scratching dartboard cabinet parts during the assembly process.
5. Assemble product on clean, level and flat surface.
6. Take time to correctly orientate parts exactly as per each assembly diagram.
7. Save this instruction in the event that the manufacturer has to be contacted for replacement parts.

**CAUTION:****READ ASSEMBLY, OPERATING AND
SAFETY INSTRUCTIONS CAREFULLY!**

Thank you for buying our product. We try hard to ensure that our products are of high quality and free of problems, such as Manufacturing defects or missing parts. However, if you have any problems with your new product, please **DO NOT RETURN IT TO THE STORE!**

Please Do Not Return This Product To The Store!

Contact Escalade Sports customer service department at:

Phone: 1-800-467-1421 Toll-Free!
E-mail: customerservice@escaladesports.com

Mailing Address (correspondence only):
Escalade Sports
817 Maxwell Ave., Evansville, IN 47711

Please provide model number and/or part number of the product and/or part when you call or write. These numbers can be found on the product, packaging, and/or in this Owner's Manual.

Please visit our website at: www.escaladesports.com

ON-LINE TROUBLE SHOOTING
FREQUENTLY ASKED QUESTIONS

ON-LINE PARTS REQUESTS
ADDITIONAL ESCALADE SPORTS

TECHNICAL ASSISTANCE
PRODUCT INFORMATION

First Time Battery Installation:

- Locate battery compartment for this product.
- Use alkaline batteries for maximum performance.
- Using a small Phillips head screwdriver – loosen and remove the battery compartment cover screw(s).
- Remove battery compartment cover.

Install new batteries only after reading the “ Battery Information NOTICE“ !

Replace compartment cover and secure cover with the cover screw. Do not over tighten and strip out the screw.







IMPORTANT: BATTERY INFORMATION

Please retain this information for future reference. Batteries must be installed / replaced by an adult .

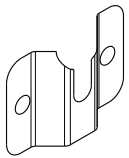
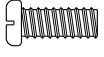
Notice:

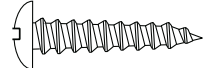
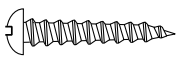
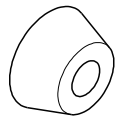
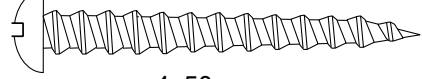
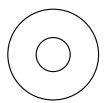
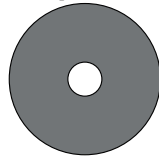
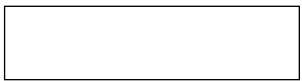
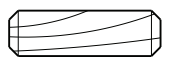
1. Remove and replace batteries when the electrical features of this product work slowly or are not functional.
2. Do not mix old and new batteries.
3. Do not mix different types of batteries : Alkaline , Standard (Carbon-Zinc) , or rechargeable (Nickel-Cadmium batteries).
4. Use Alkaline Batteries for maximum performance.
5. Do not use damaged batteries.
6. Use only batteries of the same or equivalent type as recommended.
7. Install new batteries as per matching the battery polarity guide (+ & - , positive and negative) inside of the battery compartment. Correct battery polarity installation is critical as to not damage the internal electrical components as well as insuring the correct functionality of the product.
8. Do not short circuit the battery terminals.
9. Always remove exhausted, leaking, weak, and batteries from long periods of nonuse from the product. Battery leakage and corrosion can cause damage.
10. Check the battery terminals are clean and bright before installing new batteries.
11. Dispose of old batteries safely and per local battery disposal codes.
12. Do not dispose of batteries into a fire as they may explode or leak.
13. If removable rechargeable batteries are used , they are to be charged under adult supervision.
14. Rechargeable batteries are to removed from the product before they are charged.
15. If you use a battery charger, it should be examined regularly for damage to the cord, plug, enclosure, and other parts. Do not use a damaged or malfunctioning charger until it is properly repaired.
16. Non rechargeable batteries must not be recharged.
17. Always remove batteries from this product for extended storage and or non-use.
18. Should this product cause , or be affected by, local electrical interference, move it away from other electrical equipment. Reset (switching off and back on again and or removing and reinserting the batteries) if necessary.

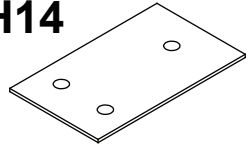
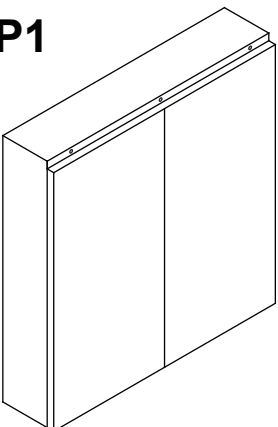
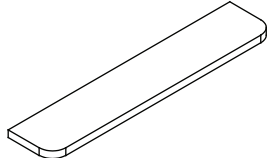
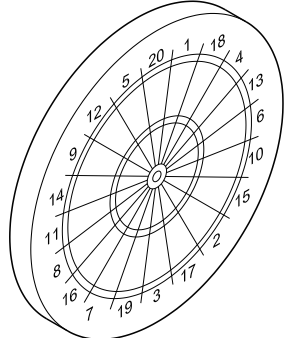
PARTS IDENTIFIER

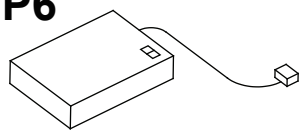
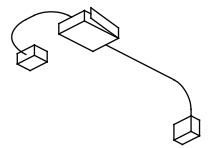
<p>H1</p>  <p>Mounting Bracket 1 pc</p>	<p>H2 (to scale)</p>  <p>3.5x10 mm Phillips Head Screw 2 pcs</p>	<p>H3 (to scale)</p>  <p>4 mm Flat Washer 2 pcs</p>	<p>H4 (to scale)</p>  <p>3 mm Nut 2 pcs</p>
<p>H5 (to scale)</p>  <p>5 x 20 mm Phillips Head Screw 1 pc</p>	<p>H6 (to scale)</p>  <p>1.5x20 mm Phillips Head Screw 3 pcs</p>	<p>H7</p>  <p>Bumper 3 pcs</p>	<p>H8 (to scale)</p>  <p>4x50 mm Phillips Head Screw 4 pcs</p>
<p>H9 (to scale)</p>  <p>4.5 mm Flat Washer 4 pcs</p>	<p>H10 (to scale)</p>  <p>20 mm EVA Pad (Peel & Stick) 4 pcs (2 pcs customer installs & 2 pcs factory preinstalled)</p>		<p>H11</p>  <p>16" Template for Mounting Dart Cabinet 1 pc</p>
<p>H12</p>  <p>Wood Dowel Pin 3 pcs</p>	<p>H13 (to scale)</p>  <p>2.5x10 mm Phillips Flat Head Screw 6 pcs</p>	<p>H14</p>  <p>Connecting Bracket 2 pcs</p>	
<p>P1</p>  <p>Dartboard Cabinet 1 pc</p>	<p>P2</p>  <p>Top Board with LED Unit 1 pc</p>	<p>P3</p>  <p>Dartboard 1 pc</p>	<p>P4</p>  <p>Darts & Flights 6 pcs</p>
<p>P5</p>  <p>Chalk & Eraser 1 set</p>	<p>P6</p>  <p>Battery Box with 3M Tape attached 1 pc</p>	<p>P7</p>  <p>Switch for LED (factory pre-installed inside the cabinet) 1 pc</p>	

TOP BOARD WITH LED UNIT INSTALLATION GUIDE

Step.1 Install H12 Wooden Dowel Pins into P2 Top Board & top cabinet frame.

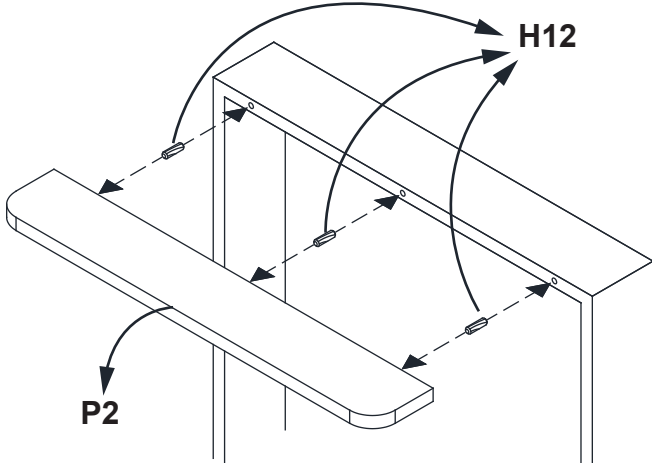

NOTE: It may be necessary to lightly tap the wooden dowel pins into the holes using a small rubber hammer. It then may be necessary to lightly tap the front LED light board tightly into place on the top front of the Dart Cabinet.

Step.2 Locate the pilot holes on the top of the LED light board and the top of the cabinet. Attach the 2 pcs H14 Connecting Brackets using H13 Screws. Tighten, but do NOT strip out the screws.

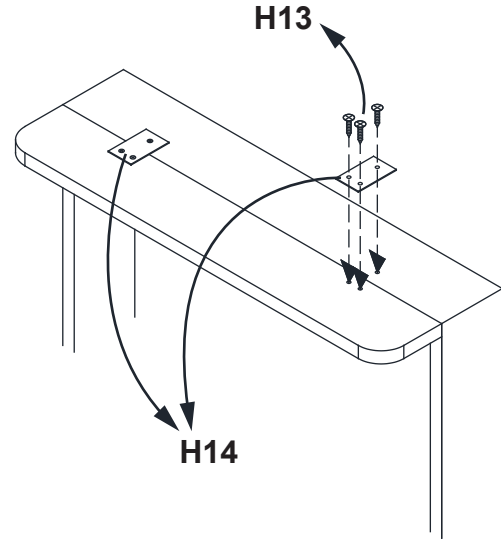

Step.3 Install and replace the batteries (3 pcs AA batteries required and NOT Included)
Note: Recommended use Alkaline battery for brighter lighting and longer battery life.

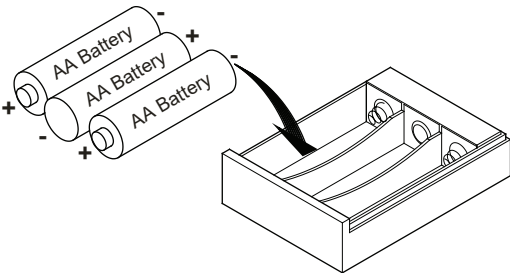

- Remove the battery box from battery cover with slide down battery box.
- Place 3 pcs AA battery in the battery box.
- Attach the battery box into battery cover with push upward on the battery box gently.
- Make sure the power switch on the battery box is in "ON" position.

WARNING: Do not mix old and new batteries and do not mix alkaline, standard (carbon-zinc), or rechargeable (ni-cad, ni-mh, etc.) batteries.

Step.4

Snap Lock

Female to Male

Tab for Snap Lock

NOTE: ON/OFF Switch is outside top.

Battery Box

approximately 2"

NOTE: Make sure slots on plugs are turned correctly for correct installation. DO NOT FORCE THIS CONNECTION and a flashlight will be very helpful to study both the male plug and female Plug to insure a correct connection.

Peel off 3M tape cover on battery cover and stick on the inner side of cabinet side frame with distance approximately 2" from top inside frame.

INSTALL THE DARTBOARD MOUNTING BRACKET INTO CABINET

Step.1 Install Mounting Bracket

1. Align 2 holes on the H1 Mounting Bracket with the 2 backboard center holes.
 2. Using 2 pcs H2 Screw and H3 Washer, insert from the cabinet backside and go through the 2 backboard center holes.
 3. Install 2 pcs H4 Nut onto 2 pcs H2 screws, tighten using plyers & phillips driver.
- Refer to **Figure 1** & **Figure 1.1**.

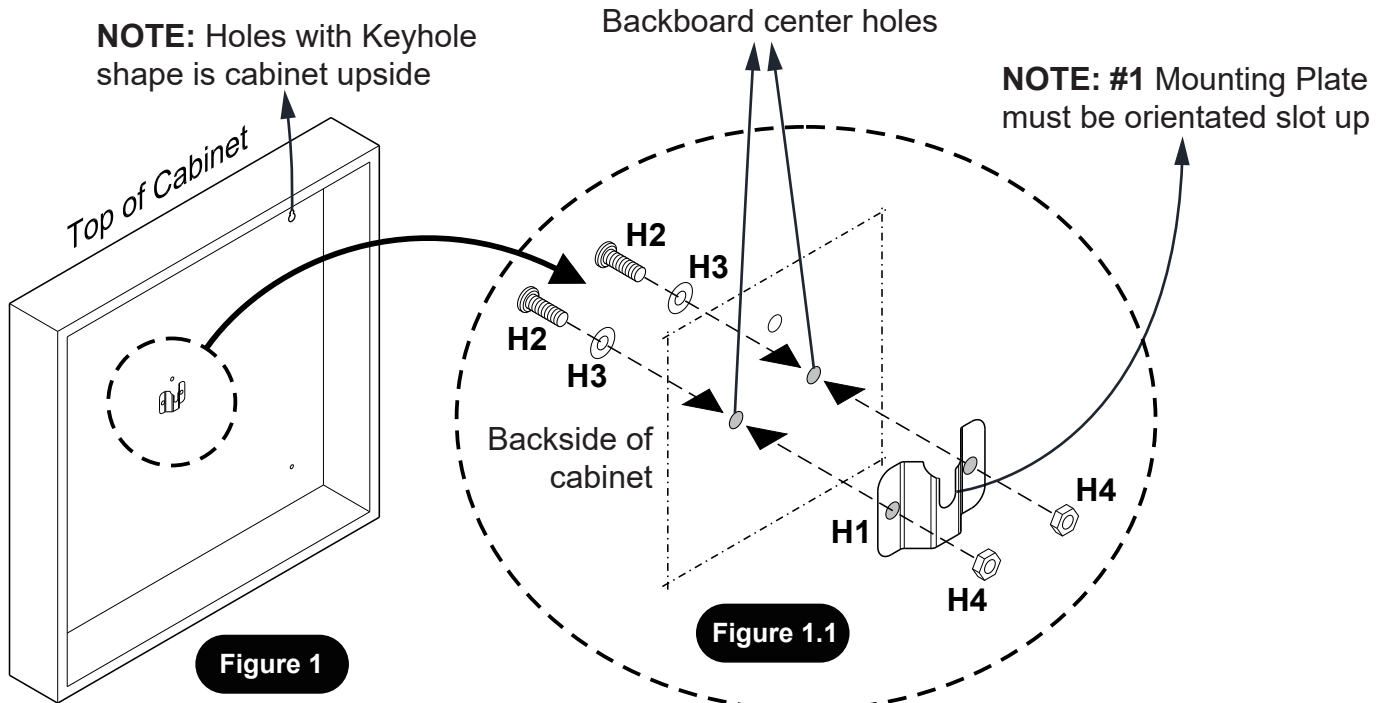

***NOTE:** Cabinet doors and LED light board not shown for clarity.

Step.2 Mount Dartboard Cabinet onto Wall

Important Safety Information:

Install and use this dartboard cabinet with care. Please read the entire manual and all instructions before attempting installation and carefully follow all instructions contained herein. Use proper safety equipment during installation which includes ANSI-Approved safety glasses and heavy duty work gloves.

Note: FAILURE TO READ AND FOLLOW THESE INSTRUCTIONS WILL VOID THE WARRANTY.

Please call a qualified installation contractor for help if you:

- A. Don't understand the instructions in this manual or have any doubts about the safety of this installation .
- B. You are uncertain about the nature of your wall .
- C. You decide to hang the dart cabinet in a manner that does not utilize the "WOOD STUD MOUNTING INSTRUCTIONS BELOW ".

Do not use this product for any purpose or in any configuration not explicitly specified in these instructions. Escalade Sports hereby disclaims any and all liability for injury or damage arising from incorrect assembly, incorrect mounting or any incorrect use of this product.

Note: The mounting hardware supplied with this product is **NOT** designed for installation to walls with steel or aluminum studs, cinder block walls, brick, stone, hollow walls, gypsum board, drywall and or similar materials. If the hardware for your installation is not included , please consult your local hardware store for the proper mounting hardware for this product as per your application.

Note: As a convenience to our Valued Customers , we have designed this Dart Cabinet Mounting Instruction to be able to be performed by one adult.



Tools required:

- Stud Finder
- Tape Measure .
- Small & Medium Phillips driver – Electric OK --- Low torque as to not strip out any screws .
- Carpenters Level
- Awl and or Pencil
- Drill and 1/16" Drill Bit
- Thin Nail
- Plyers

WOOD STUD MOUNTING WITH WOOD STUDS AT 16" ON CENTER:

Verify that the mounting surface has no hidden utility lines before drilling or driving screws.

DO NOT MOUNT THE CABINET TO, A HOLLOW WALL, GYPSUM BOARD, DRYWALL OR SIMILAR MATERIALS THAT WILL NOT SUPPORT THE WEIGHT OF THE DART BOARD CABINET AND BRISTLE BOARD.

The dart board cabinet must be mounted to two wood studs. Use a stud finder to locate two adjacent wood studs. It is a good idea to verify exactly where the studs are located with an awl or thin nail.

Note: "Stud Finders " are available at your local hardware store.

IMPORTANT NOTES:

The height of the cabinet, is decided by the correct height of the dart board's BULL'S EYE. This measurement is with the dartboard installed into the cabinet and is 5'8", or 68", or 1.7 m from the Bulls Eye to the floor.

Also, double check that the cabinets 4 mounting holes are 16" on center both horizontally and vertically (Just as a double check).

Make sure the holes you are about to drill are in the **center of the stud**, and **level** with each other. The drill bit **MUST** be smaller than the Cabinet Wall Mounting Screws.

At this point you have completed the following steps:

- Decided where you want to hang the Dartboard Cabinet.
- You have correctly located 2 adjacent 2" x 4 " wooden studs.
- You have determined the center of each of the 2" x 4" vertical studs.

- Next, locate the **H11** - 16" Template for Mounting Dart Cabinet packed with the product.
On the left and right stud, measure up from the floor 76" and using an awl or pencil, mark 76" at the center of each stud.
- Using the **H11** template, place the left circle on the template exactly correct over the 76" mark.
- Now, holding the template horizontal and flat to the wall, use the **H11** template and mark the right stud at the 76" mark .
- Please confirm the 2 measurements now marked on the wall.
 - The vertical measurements from the floor to the mark on each stud is 76".
 - The horizontal measurement is exactly 16" from the center of the left stud to the center of the right stud.
- Lastly, use a carpenters level and make sure the two 76" marks are exactly level with each other. Remark the 76" marks as required to achieve levelness while maintaining the 16" on center distance between the two.
- Using a 1/16" drill bit carefully drill a Pilot Hole straight into each of the 2 marked areas.
- Again, confirm exactly 16" on center between the two holes and each is 76" from the floor, and the holes are level with each other.
- Remove H11 template from the wall.**
- Peel and stick 2 pcs **H10** EVA Pad aligned with the 2 pilot holes onto the wall.
- Next, locate 2 pcs **H8** Screws, install through EVA pad holes into the pilot holes as per **Figure 2.1**.

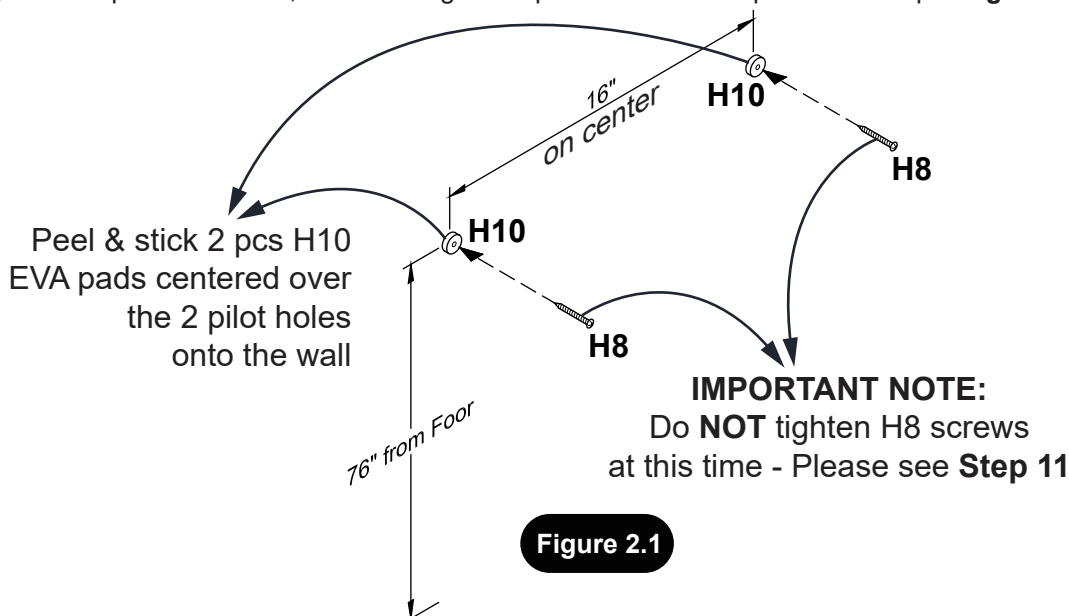

11. Now, install **H8** screws into each drilled pilot hole leaving approx. **1/2"** of the screw head exposed from the wall as per **Figure 2.2**. (This will allow you to "Hang" the Dart Cabinet onto these two screws).
12. Carefully hang the dart cabinet onto these two hanging screws. Make sure the cabinet gently drops down into the "keyhole slots" on the back of the cabinet. Snug Tighten screws. Snug only as these screws will be temporarily removed and reinstalled momentarily. Please see **Figure 2.3**.
13. Now, using the drill and 1/16" drill bit carefully drill pilot holes, using the bottom two holes in the back lower part of the cabinet as guides. Install 2 pcs **H8** Wall Mounting Screws with **H9** Washers and tighten, do not strip out the screws. See **Figure 2.3**.

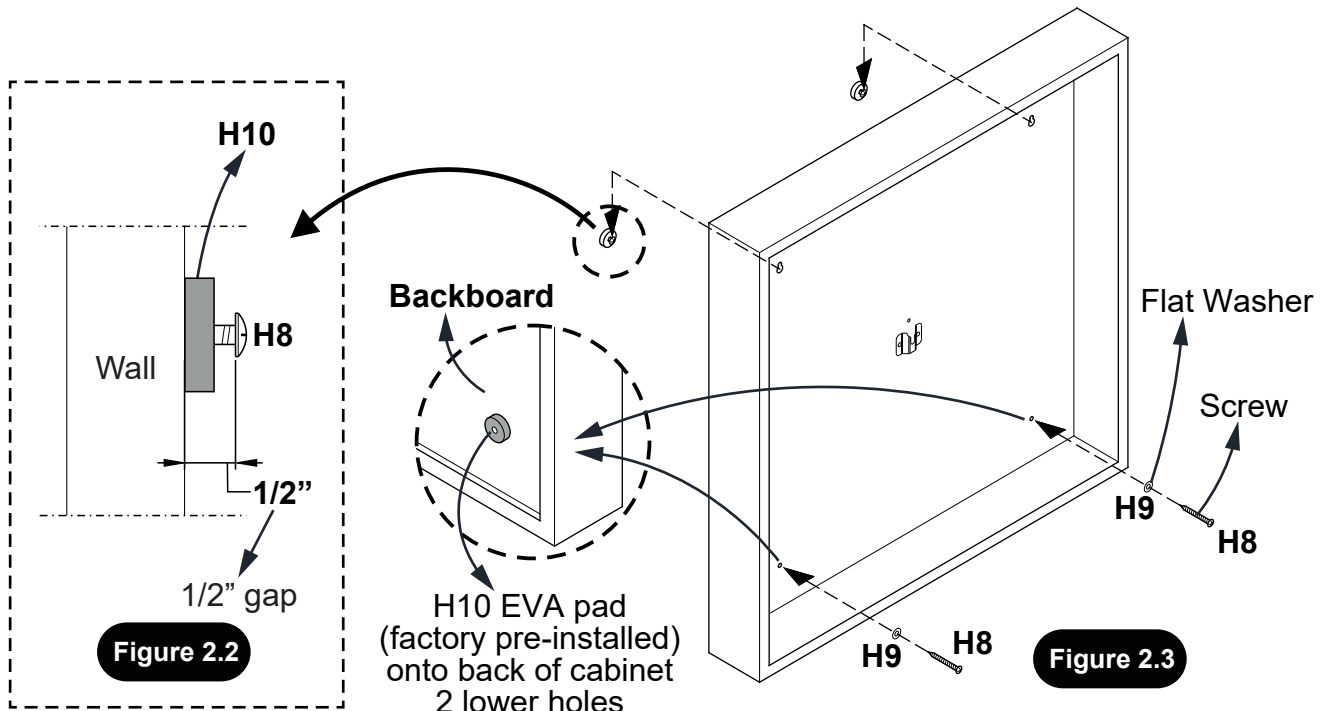

15. Next, and **only one at a time**, remove the top **H8** screws, install a **H9** Flat Washer onto the screw, reinstall and tighten. Do not strip out the screws. See **Figure 2.4**.

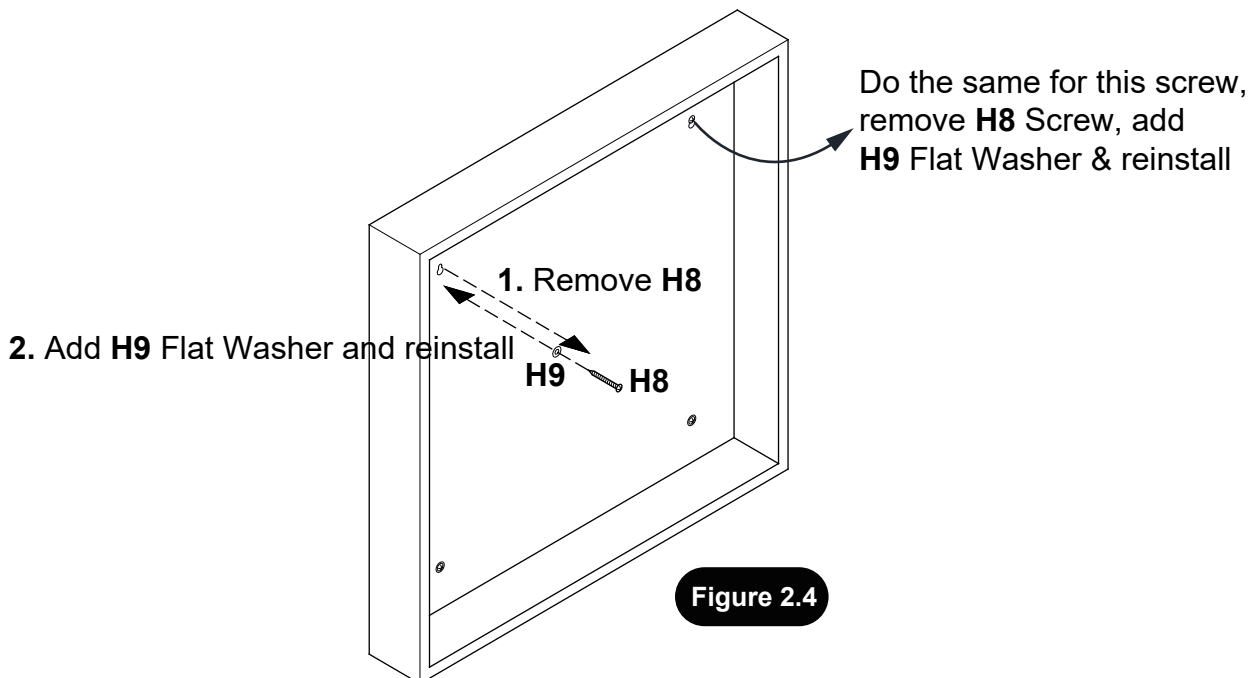

***NOTE: Cabinet doors and LED light board not shown for clarity.**

Step.3 Install Dartboard into Cabinet

1. Install **H5** Mounting Screw to the pilot hole which is marked with black marker on the **back center** of the dartboard and leave approx. 1/8" of the screw head exposed from the backboard per shown on **Figure 3.1**. (This will allow you to "Hang" the dartboard onto mounting bracket which was installed in Step 1).
2. Install 3 pcs **H7** Bumper to 3 pilot holes onto the back of the dartboard using 3 pcs **H6** Bumper Screw and tighten, do not strip out screws. Please see **Figure 3.2**.

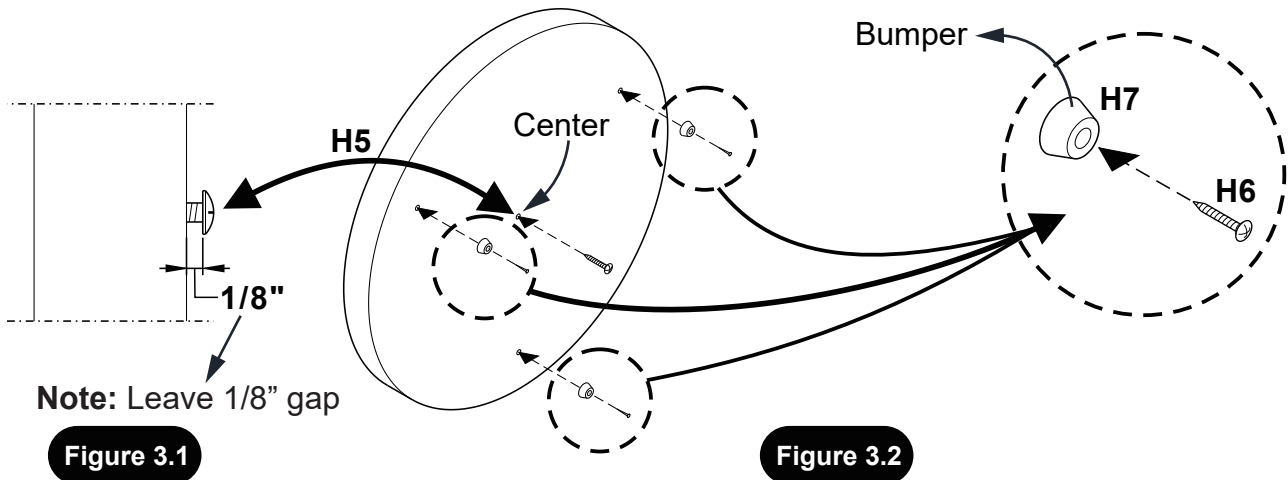

3. Hang the dartboard onto the cabinet by hanging the dartboard center screw onto the **H1** Mounting Bracket slot.
Note: While Figure 3.1 shows a 1/8" gap in order to hang the dartboard onto the hanger, a small amount of "adjusting" may be required on the H5 center screw in order to achieve the best fit for the dartboard onto the cabinet.
4. Rotate and adjust Number "20" at the top.
Please see **Figure 3.3**.

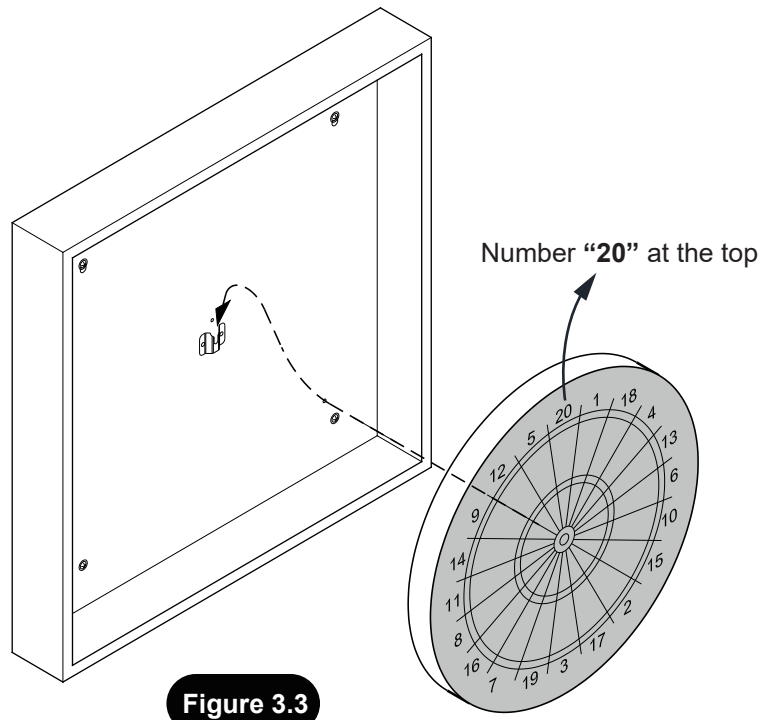

***NOTE: Cabinet doors and LED light board not shown for clarity.**

Darting Game Rules

Various darting websites are available that explain darting rules and other specifics of the game.

LIMITED WARRANTY

Escalade® Sports (the Company) warrants the Product to be free from defects in workmanship and materials under normal use and conditions **FOR A PERIOD OF 90 DAYS FROM THE DATE OF ORIGINAL PURCHASE** in the United States and Canada.

What Is Covered

Except as provided below, this Limited Warranty covers all defects in materials and workmanship. This Limited Warranty is void if the Product is:

- Damaged through improper usage, negligence, misuse, abuse, transportation damage, acts of nature, or accident (including failure to follow the instructions supplied with the Product)
- Used in commercial applications or rentals
- Modified or repaired by anyone not authorized by the Company

What Is Not Covered

This Limited Warranty does not cover:

- Any expendable items such as batteries, light bulbs, fuses, accessories, cosmetic parts, tools and other items that wear out.
- Due to normal usage. Any costs you may incur for delivery, installation, assembly or transport of your product.

What The Company Will Pay For

If during the Limited Warranty period, any part or component of the Product is found by the Company to be defective, the Company will, at its option, repair the Product, replace the Product with a new Product (either the same or an equivalent model) or cause the original retailer of the Product to exchange the Product with a new Product (either the same or an equivalent model) or refund the original purchase price of the Product, without charge for labor or parts. The Company's obligation to repair, replace or exchange the Product, however, shall be limited to the amount of the original purchase price of the Product.

How To Obtain Warranty Service

In order to enforce your rights under this Limited Warranty, you must follow these procedures:

- You must include THE ORIGINAL COPY OF YOUR SALES RECEIPT.
- You must call the Company's Consumer Service Department at 1-800-467-1421 from 8:00 A.M. to 5:00 P.M. (CST) to notify the Company of the nature of the problem.
- If you are instructed to return the Product to the Company for servicing, you are responsible for shipping the Product, at your expense, to the address designated by the Company in packaging that will protect against further damage.
- You must also include your name, address, daytime telephone number, model number of the Product and a description of the problem.

THIS LIMITED WARRANTY IS AVAILABLE ONLY TO THE ORIGINAL PURCHASER OF THE PRODUCT AND IS VALID IN THE UNITED STATES AND CANADA ONLY.

THE COMPANY'S LIABILITY IS LIMITED TO THE REPAIR OR REPLACEMENT, AT ITS OPTION, OF ANY DEFECTIVE PRODUCT AND SHALL NOT INCLUDE ANY LIABILITY FOR INDIRECT, INCIDENTAL OR CONSEQUENTIAL DAMAGES OF ANY KIND .

THIS WARRANTY IS EXPRESSLY MADE IN LIEU OF ALL OTHER WARRANTIES, EXPRESSED OR IMPLIED. SOME STATES DO NOT ALLOW LIMITATIONS ON HOW LONG AN IMPLIED WARRANTY LASTS OR DO NOT ALLOW FOR EXCLUSION OF INCIDENTAL OR CONSEQUENTIAL DAMAGES. TO THAT EXTENT, THE ABOVE LIMITATIONS MAY NOT APPLY TO YOU.

This Limited Warranty gives you specific legal rights, but you may also have other rights that vary from state to state. If you have questions regarding this Limited Warranty or the operation of the Product, you may call or write us:

**Consumer Service Department
817 Maxwell Ave.
Evansville, IN 47711
1-800-467-1421
www.escaladesports.com**