













King Assembly Instructions

Hardware List includes factory installed bolts and washers for side rails attachment.

A	B	D	E	F	I	J	M	N	O	P	Q
											
8PCS	0PC	6PCS	8PCS	4PCS	1PC	6PCS	6PCS	26PCS	2PCS	39PCS	2PCS

①

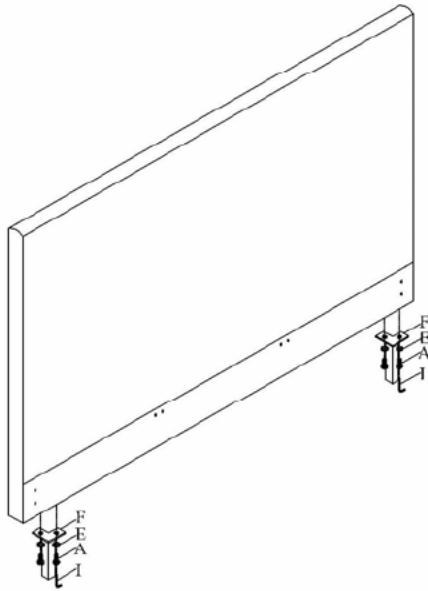

②

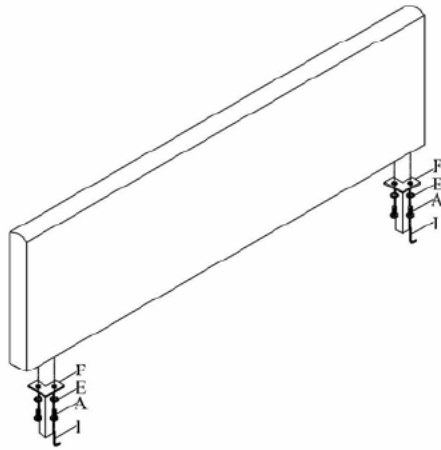

③

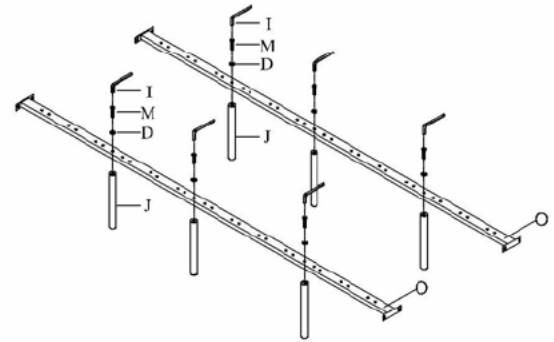

Step#1

Retrieve feet from behind HB. Attach bed feet (F) to the headboard using Wrench (I), Bolt (A) and Washer (E).

Step#2

Attach bed feet (F) to the footboard using Wrench (I), Bolt (A) and Washer (E).

Step#3













Attach steel center support legs (J) to the center support rail (O) using Wrench (I), Bolt (M) and Washer (D).

CONGRATULATIONS ON YOUR NEW BED PURCHASE

~Warning:do not move bed after final assembly as it may result in damages to floor and/or bed.~

King Assembly Instructions

Hardware List includes factory installed bolts and washers for side rails attachment.

A	B	D	E	F	I	J	M	N	O	P	Q
 ø8*20MM	 ø8*30MM	 ø6MM	 ø8MM	 H=120MM	 ø8MM	 H=205MM	 ø6*40MM				
8PCS	0PC	6PCS	8PCS	4PCS	1PC	6PCS	6PCS	26PCS	2PCS	39PCS	2PCS

④

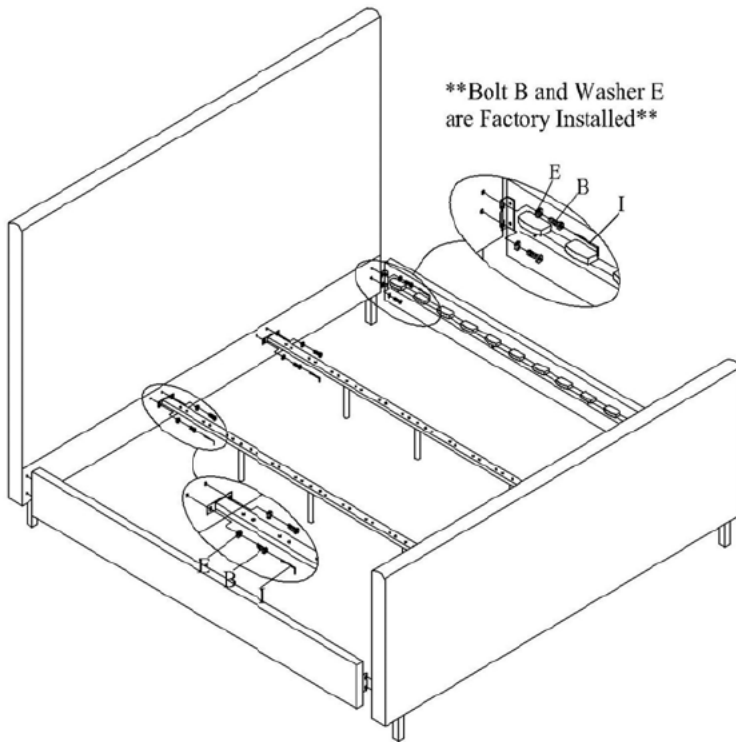

⑤

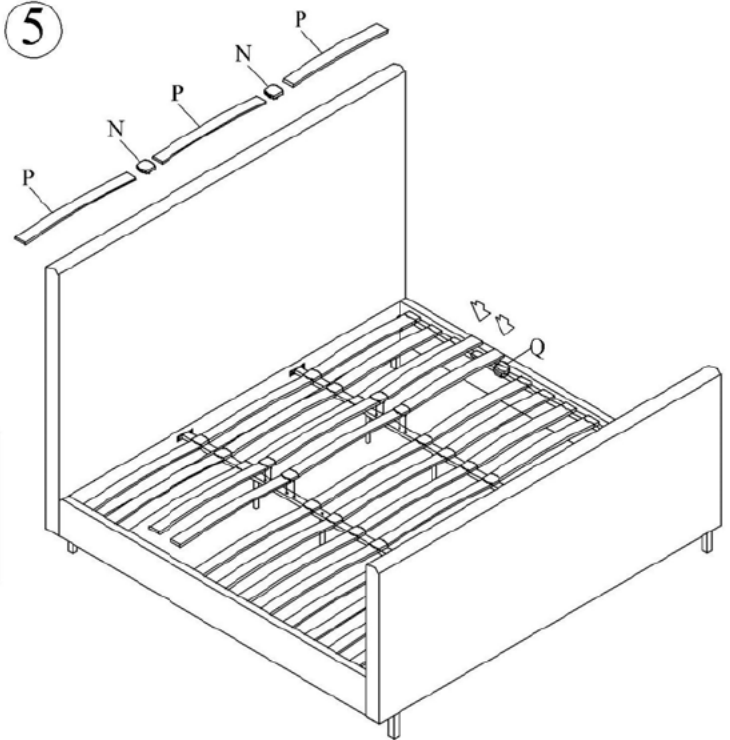

Step#4

Attach side rails to headboard and footboard using factory installed Bolt (B) and Washer (E).
Attach steel center support rail to the headboard and footboard using factory installed Bolt (B) and Washer (E).

Step#5 (IMPORTANT: Make sure slats are inserted into center clip BEFORE snapping into place)

Verify Euro Slat System Tension Slats are installed curved upwards per diagram.
Insert tension slats into Center Clip (N) and factory installed End Clip (Q) before snapping into place.

CONGRATULATIONS ON YOUR NEW BED PURCHASE

~Warning: do not move bed after final assembly as it may result in damages to floor and/or bed.~