

Assembly Manual

ROCKING CHAIR

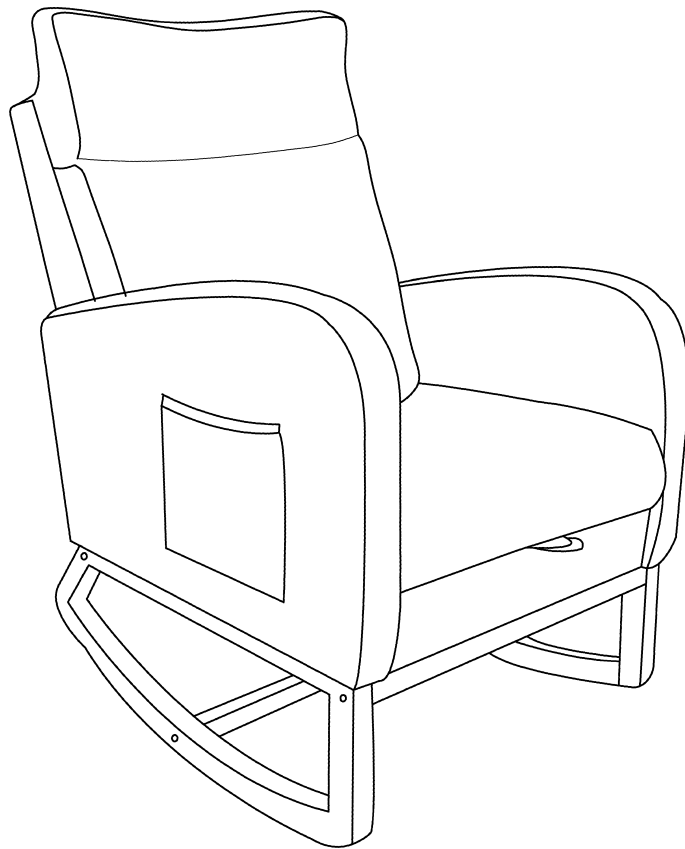

Please read this manual carefully before any operation and keep it properly for future use.

Assembly note:

15 min

Assembly Time

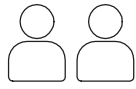

Two People

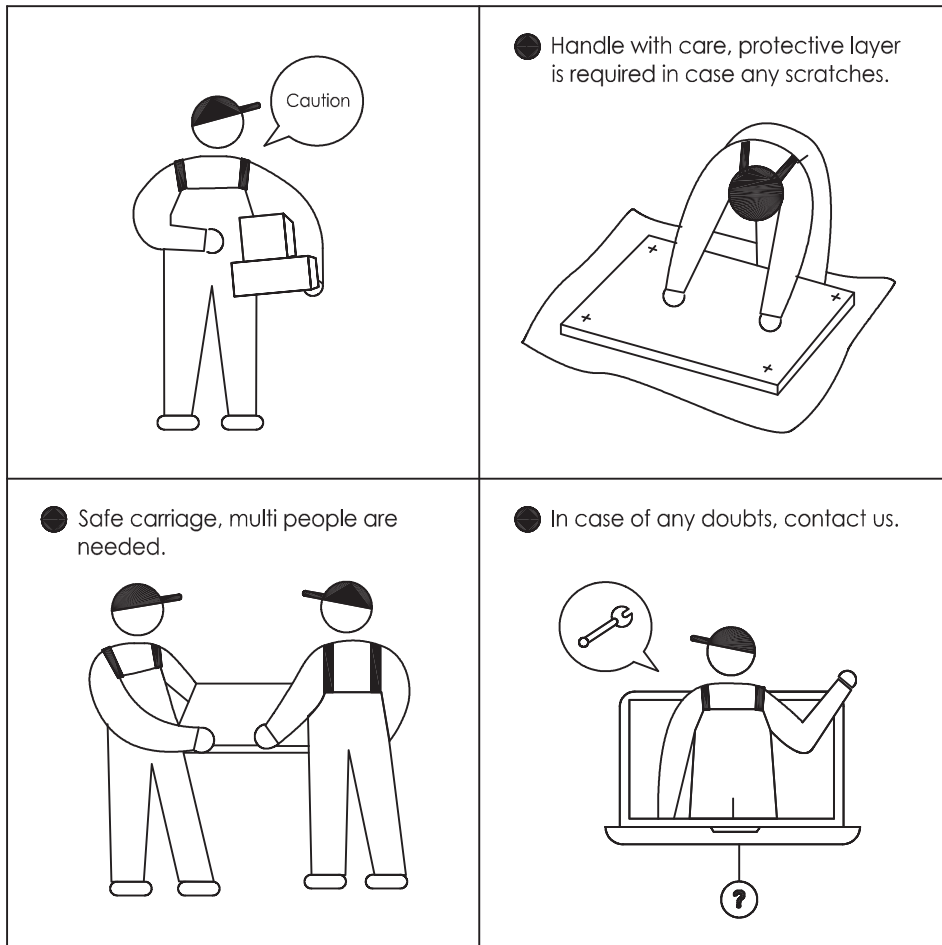







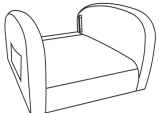

CONTACT US

If you have any problems or concerns about your purchase, please get in touch with our customer service as soon as possible and we will do everything we can to help.

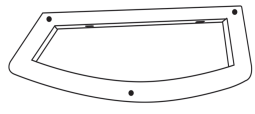
You will be highly appreciated if you can put your order number in the email title so that we can deal with it efficiently.

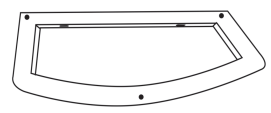
Components List

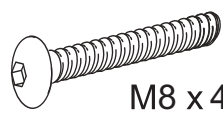
NO.	PARTS	QTY	NO.	PARTS	QTY
A		1	E		2
B		1	F		1
C		3	L		1
D	 M6 x 45mm	4+1	R		1
G	 M6 x 25mm	8+1			
H	 M8 x 45mm	6+1			

Note: The number after “+” sign indicates the extra piece(s).

Assembly Instruction

STEP 1

Attach the female connectors(E) to the seat(A) using bolts(G) and Allen Wrench(F)

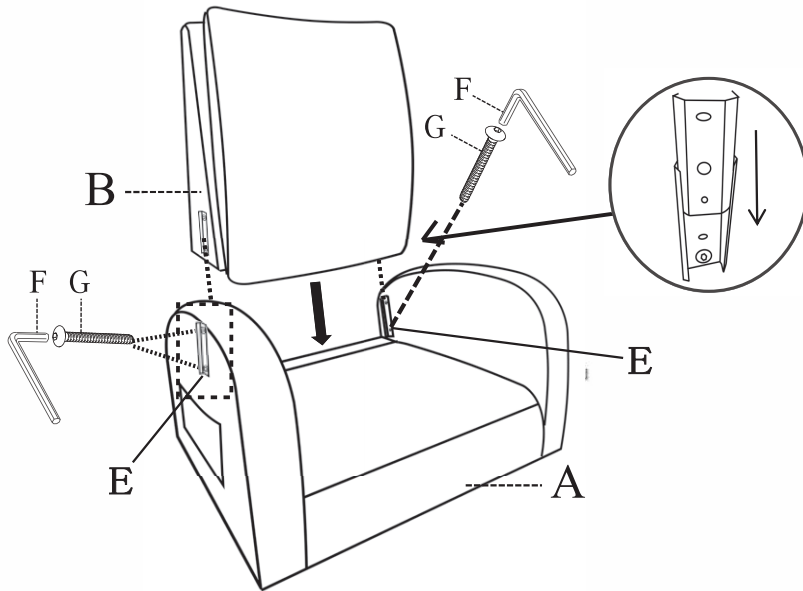

STEP 2

Insert the male connectors of backrest(B) to the female connectors of seat as the picture shown below.

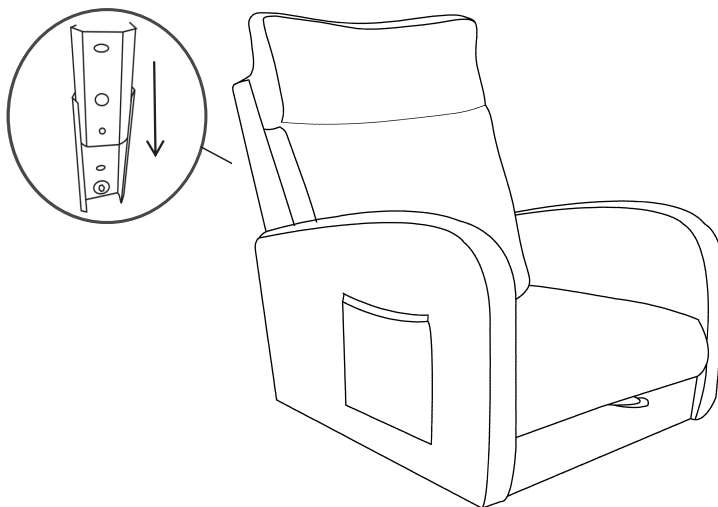

Assembly Instruction

STEP 3

Attach the runners to the underside of the seat using bolts(D) and Allen wrench(F). Do NOT fully tighten the bolts until all of them are in the right holes. This will allow you slight adjustments during assembly.

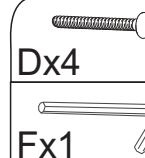
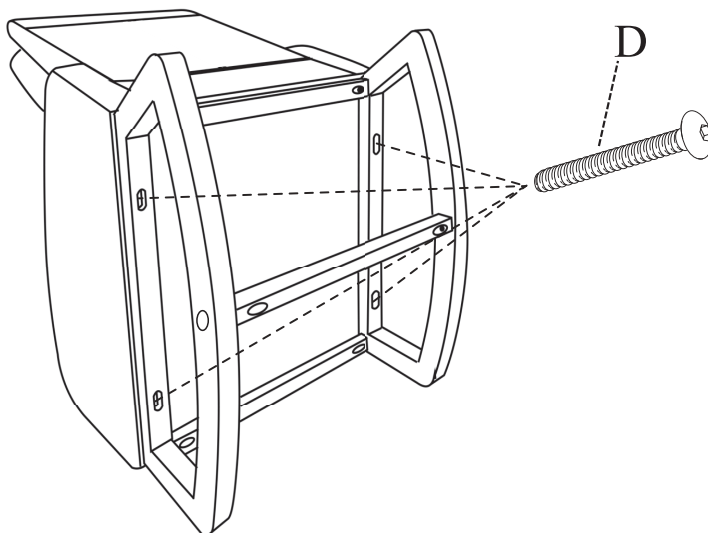

STEP 4

Attach the crossbars (C) to the left and right runners(L&R) using bolts(H) and Allen wrench. Attach the middle one first will be much easier. Do NOT fully tighten the bolts until all of the bolts are in the correct holes. This will allow you slight adjustments to the positions during the assembly.

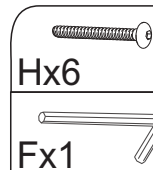
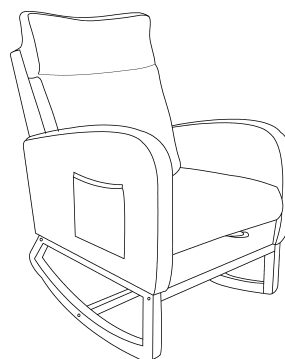
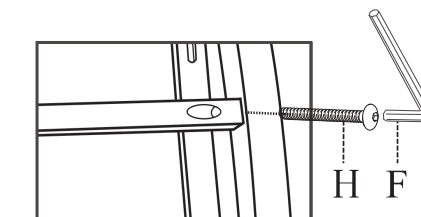
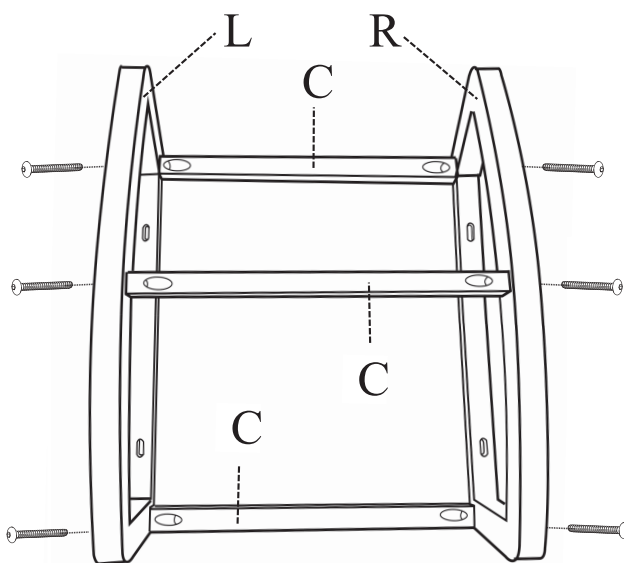

Assembly Instruction

STEP 5

Assembly is completed.

