

Features

- Two-way diverter valve
- Diverter valve code-approved for backflow protection
- 15 gpm (57 lpm) flow rate using 1/2" high-flow valves
- Handshower sold separately
- Coordinates with Components faucets, accessories, and showering components to complete your bathroom

Material

- Brass
- KOHLER finishes resist corrosion and tarnishing

Installation

- Deck- or bath-mount

Recommended Products/Accessories

- K-72421-G Three-function handshower, 1.75 gpm
- K-22165-G Four-function handshower, 1.75 gpm
- K-22166-G Four-function handshower, 1.75 gpm
- 79583 Roughing-in Kit for Deck-Mount Handshowers
- K-21335-G Round two-function handshower, 1.75 gpm

Included Components

- GP78825 Polished Chrome hose kit



Codes/Standards









ASME A112.18.1/CSA B125.1

KOHLER® Faucet Lifetime Limited Warranty

See website for detailed warranty information.

Available Colors/Finishes

Color tiles intended for reference only.

Color	Code	Description
	CP	Polished Chrome
	SN	Vibrant® Polished Nickel
	AF	Vibrant® French Gold
	BN	Vibrant® Brushed Nickel
	BV	Vibrant® Brushed Bronze
	BL	Matte Black
	2MB	Vibrant® Brushed Moderne Brass
	TT	Vibrant Titanium
	BGP	Brushed Graphite

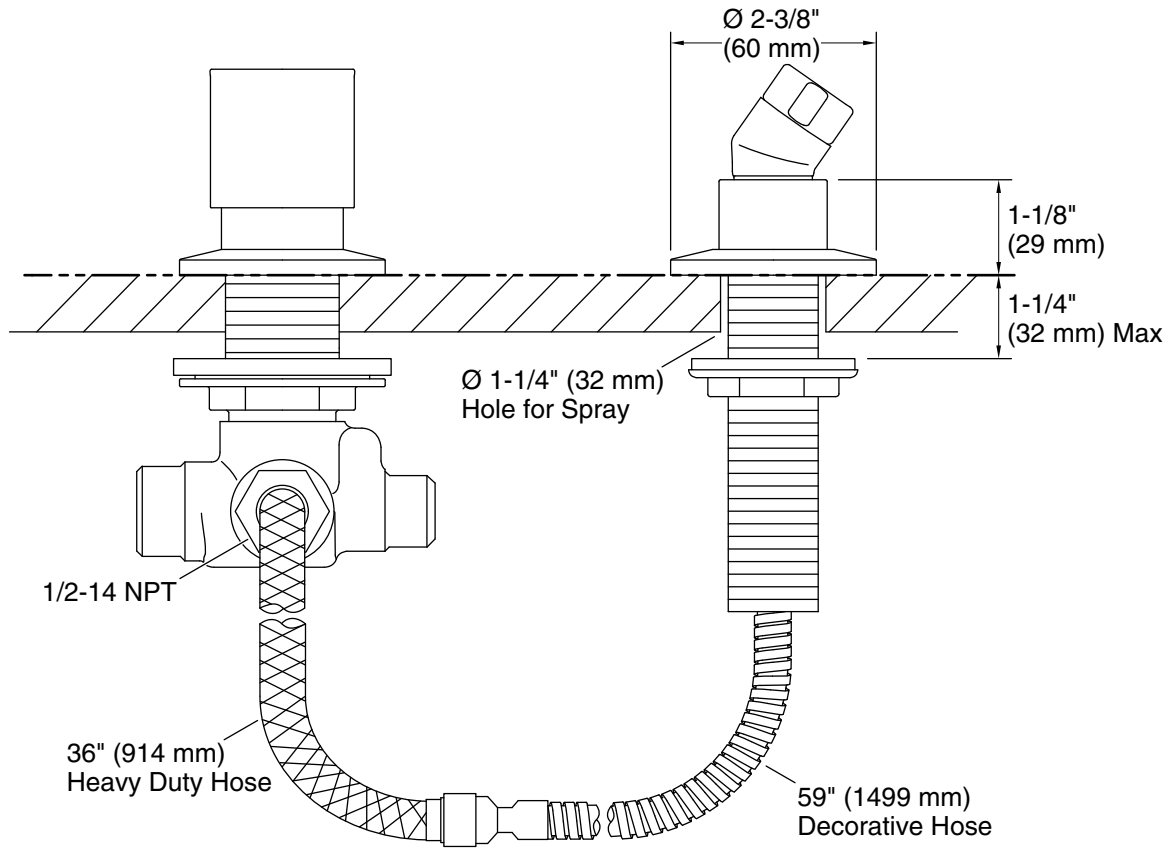

Technical Information

All product dimensions are nominal.

Spout:

Shower Valve:

Flow Rate (Max) @ 45 psi	15 gal/min (56.8 l/min)
Pressure:	45 psi (3.1 bar)
Maximum (Static) Pressure:	125 psi (8.6 bar)

Notes

Install this product according to the installation instructions.