

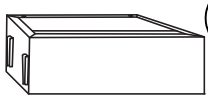

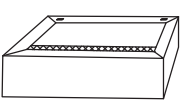

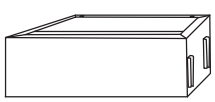

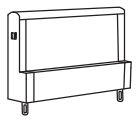

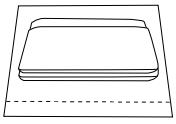
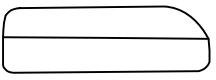
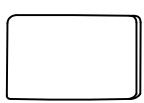

ASSEMBLY INSTRUCTION

Accessories List

 (A) Left Sofa base(1)	 (B) Middle Sofa base(2)	 (C) Right Sofa base(1)	 (D) Left Backrest(1)	 (E) Middle Backrest(2)
 (F) Right Backrest(1)	 (G) Left Armrest(1)	 (H) Right Armrest(1)	 (I) Cushion Package (4)	 (J) Seat cushion(4)
 (K) Back cushion(4)	 (L) Left Hand pillow(1)	 (M) Right Hand pillow(1)	 (N) Waist Pillow (2)	 (O) Leg(16)
 (P) Plastic Washer (16)	 (Q) Metal Clip (6)			

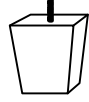
STEP1: Remove the backrest, seat cushion, back cushion, hand pillow, pillow and legs from the bottom of the sofa base.

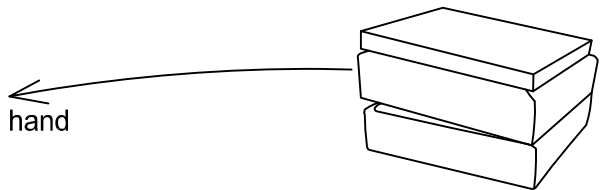

STEP2: Inster the armrest into the sofa base.

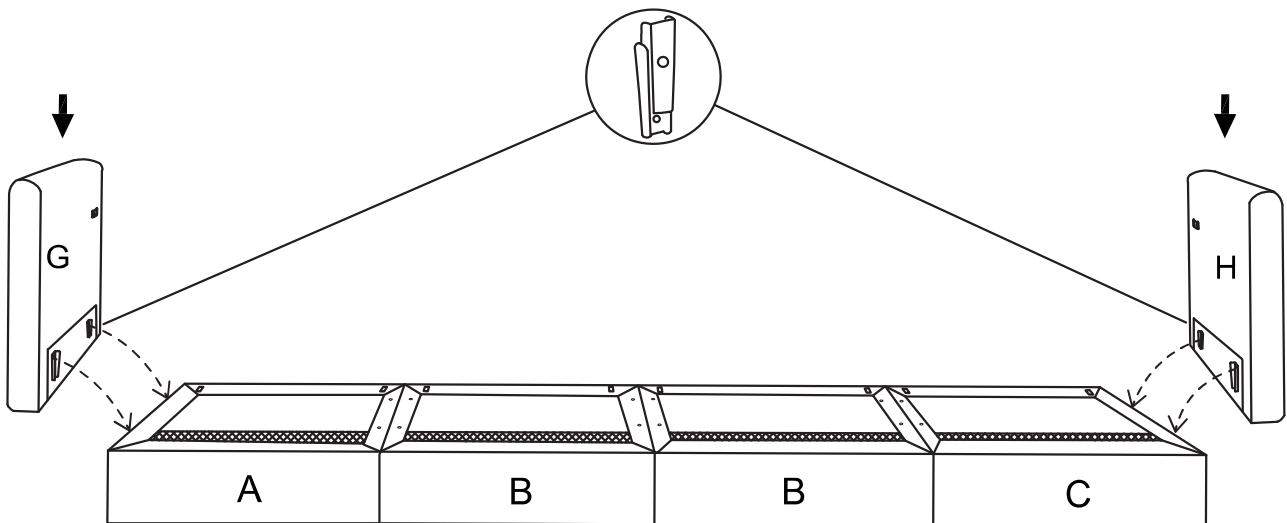

STEP3: Insert the backrest into the sofa base.

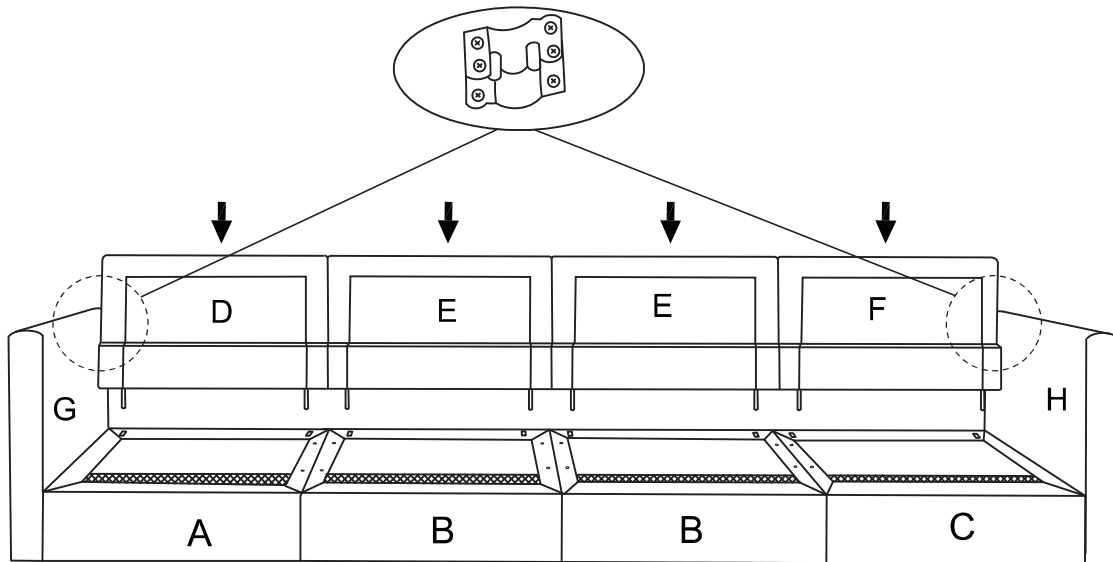

STEP4: Screw the legs clockwise. Gentle Reminder: There are only 2 holes for the legs at the bottom of the corner seats because the other 2 Legs should be installed to the armrest.

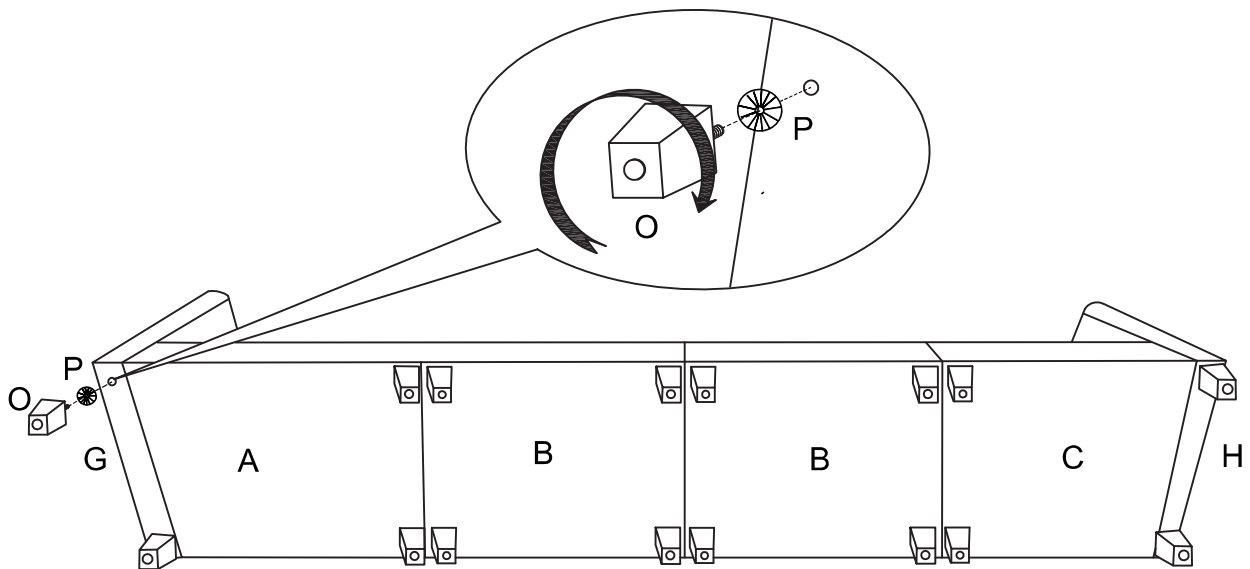

STEP5: Connect the seats with the Metal Clips (Q).

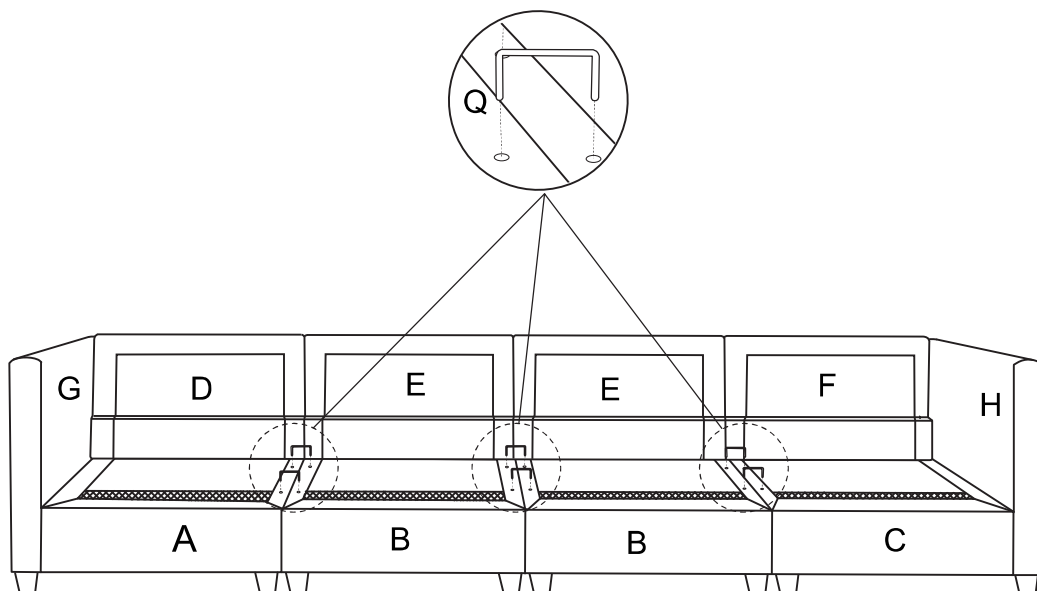

STEP6: Cut the cushion packages,remove four seat cushions and back cushions.
Full decompression may take up to 72 hours.

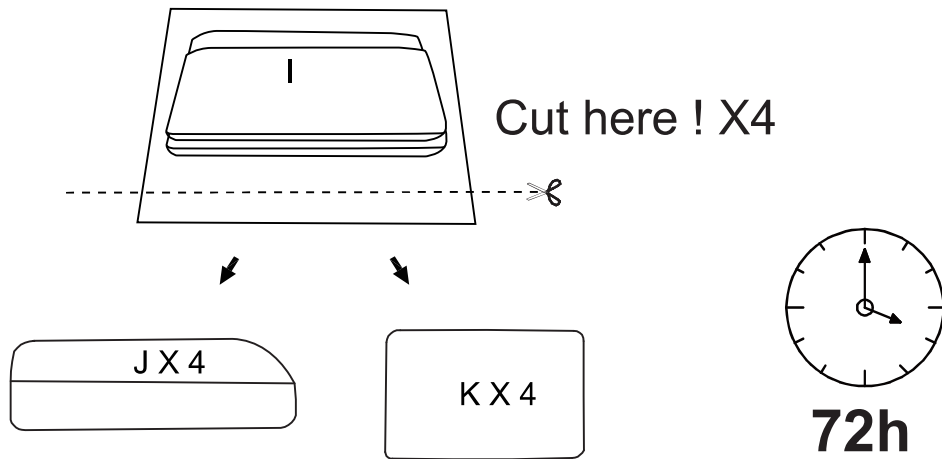

STEP7: Put the seat cushions, back cushions and armrest pillows on the sofa in turn,then put the waist pillows on the seat.

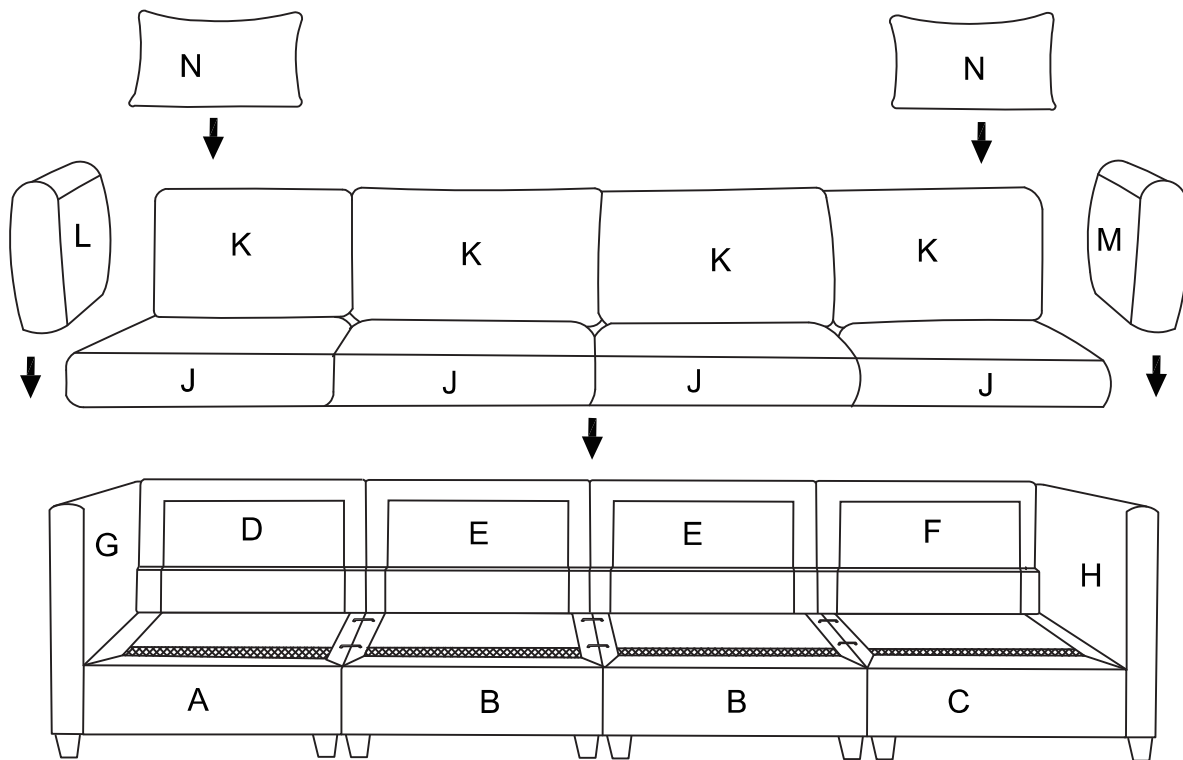

Complete

