

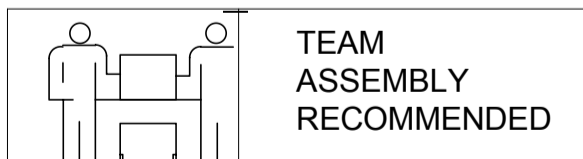

INSTRUCTION

WF322620

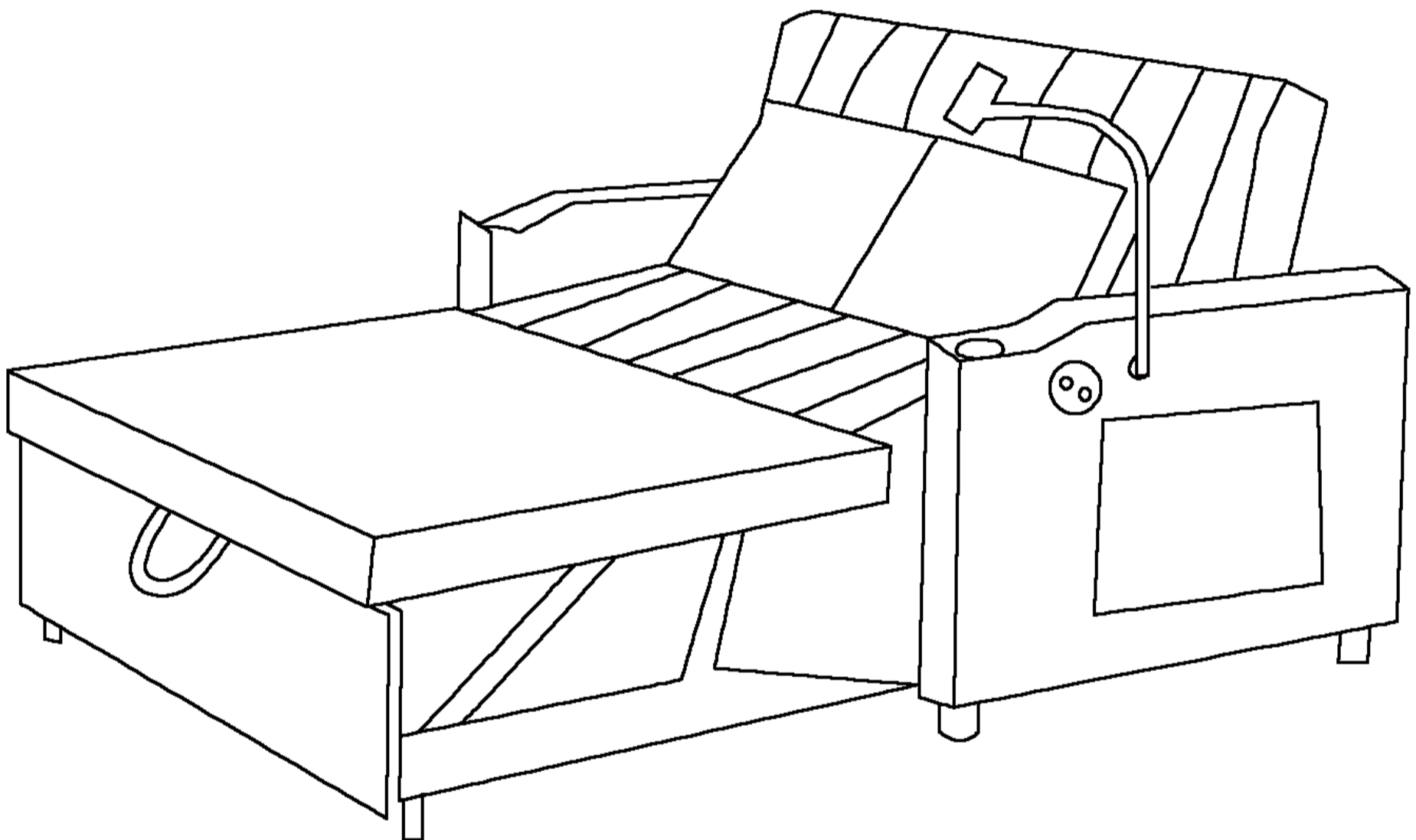

SOFA BED

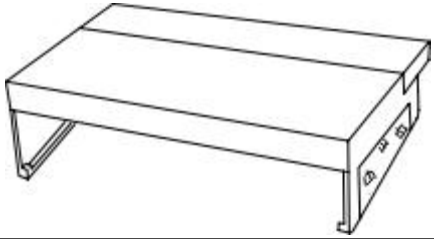
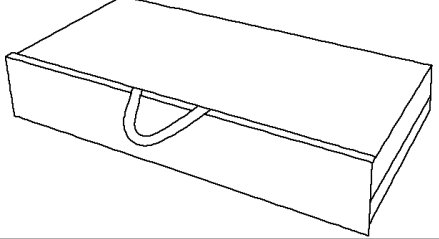
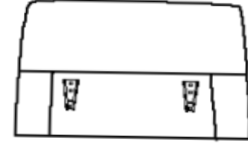
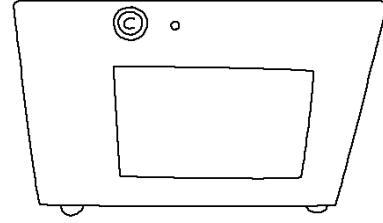
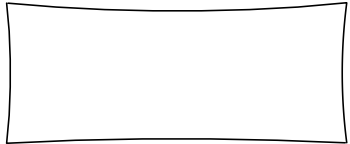
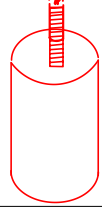
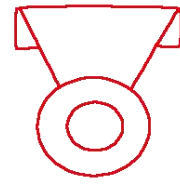

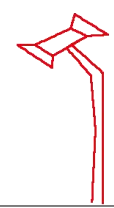
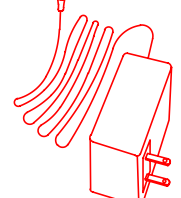

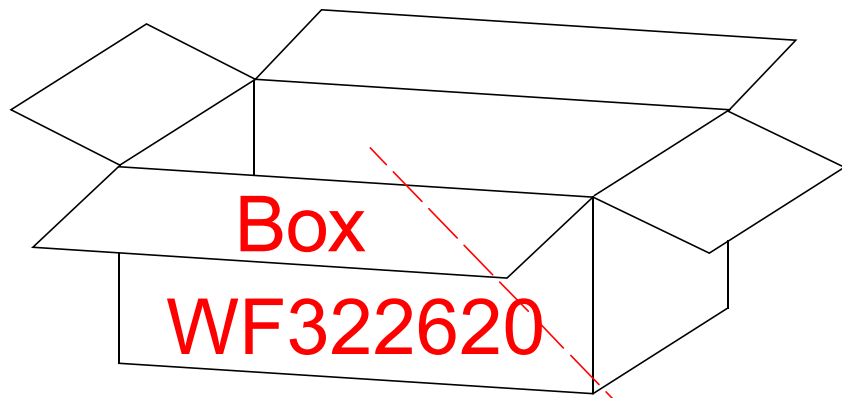

PARTS LIST

NO	PART	DECS	QTY
A		SEAT CUSHION	1pc
B		TRUNDLE BED	1pc
C		LEFT ARM	1pc
D		RIGHT ARM	1pc
E		PILLOW	2pc
F		LEGS	4pc
G		GUIDE-RAIL WHEEL	4pc
H		SHORT SCREW	17pc
I		SCREWS AND NUTS	1pc
J		MOBIIE PHOHE HOLDER	1pc
K		USB POWER	1pc

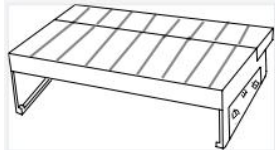
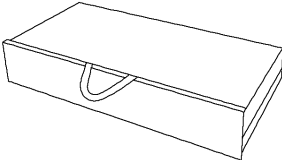
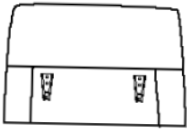
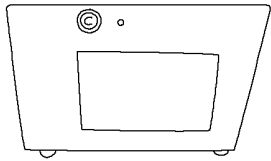
STEP 1

Ship by 1 box

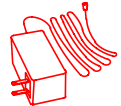

NO	PART	DECS	QTY
(A)		SEAT CUSHION	1pc
(B)		TRUNDLE BED	1pc
(C)		LEFT ARM	1pc
(D)		RIGHT ARM	1pc
(E)		PILLOW	2pc
(F)		LEGS	4pc
(G)		LEGS	4pc
(H)		SHORT SCREW	17pc
(I)		SCREWS NUTS	1pc
(J)		Mobile phone holder	1pc
(K)		USB POWER	1pc

STEP 2

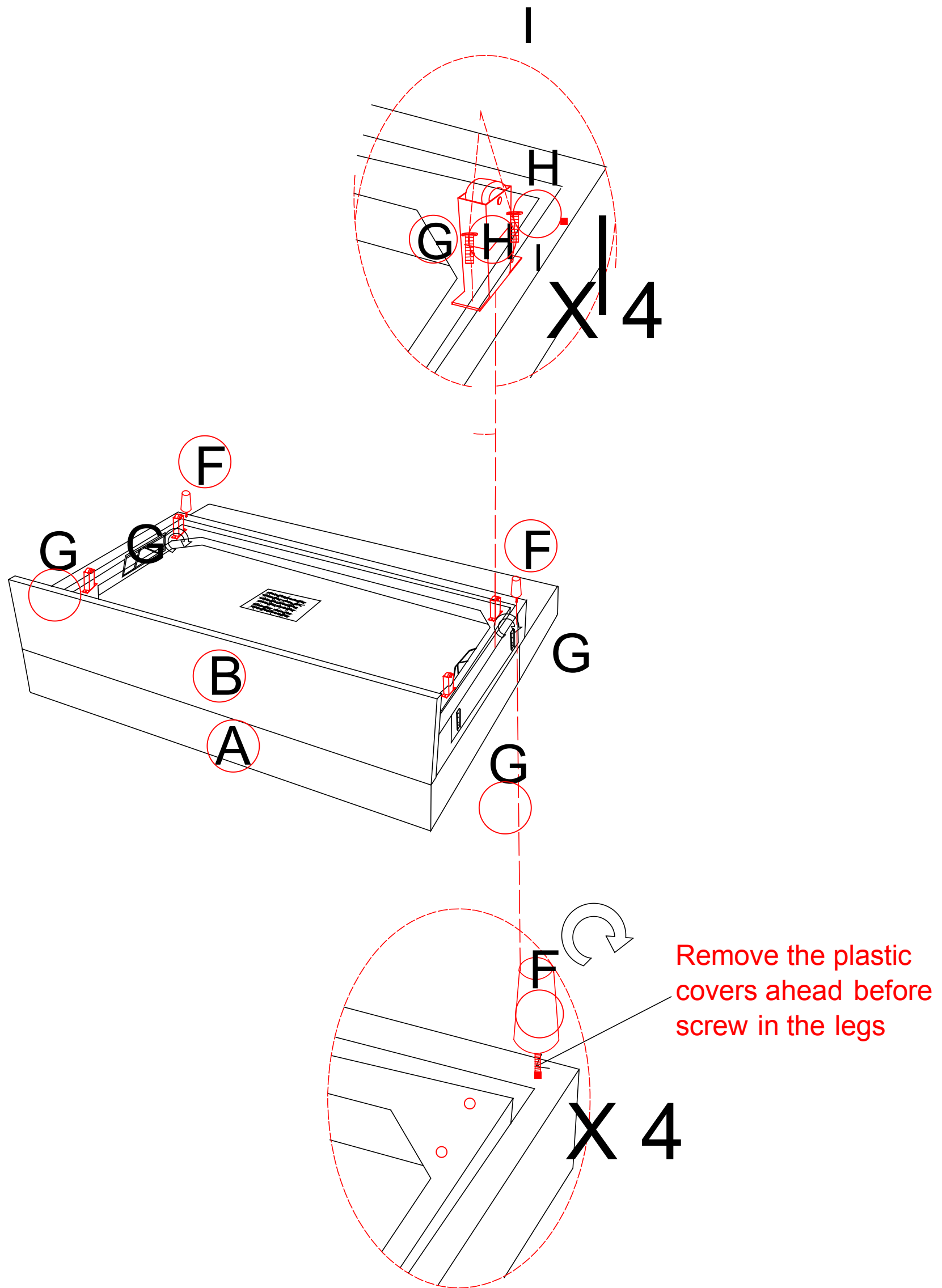

STEP 3

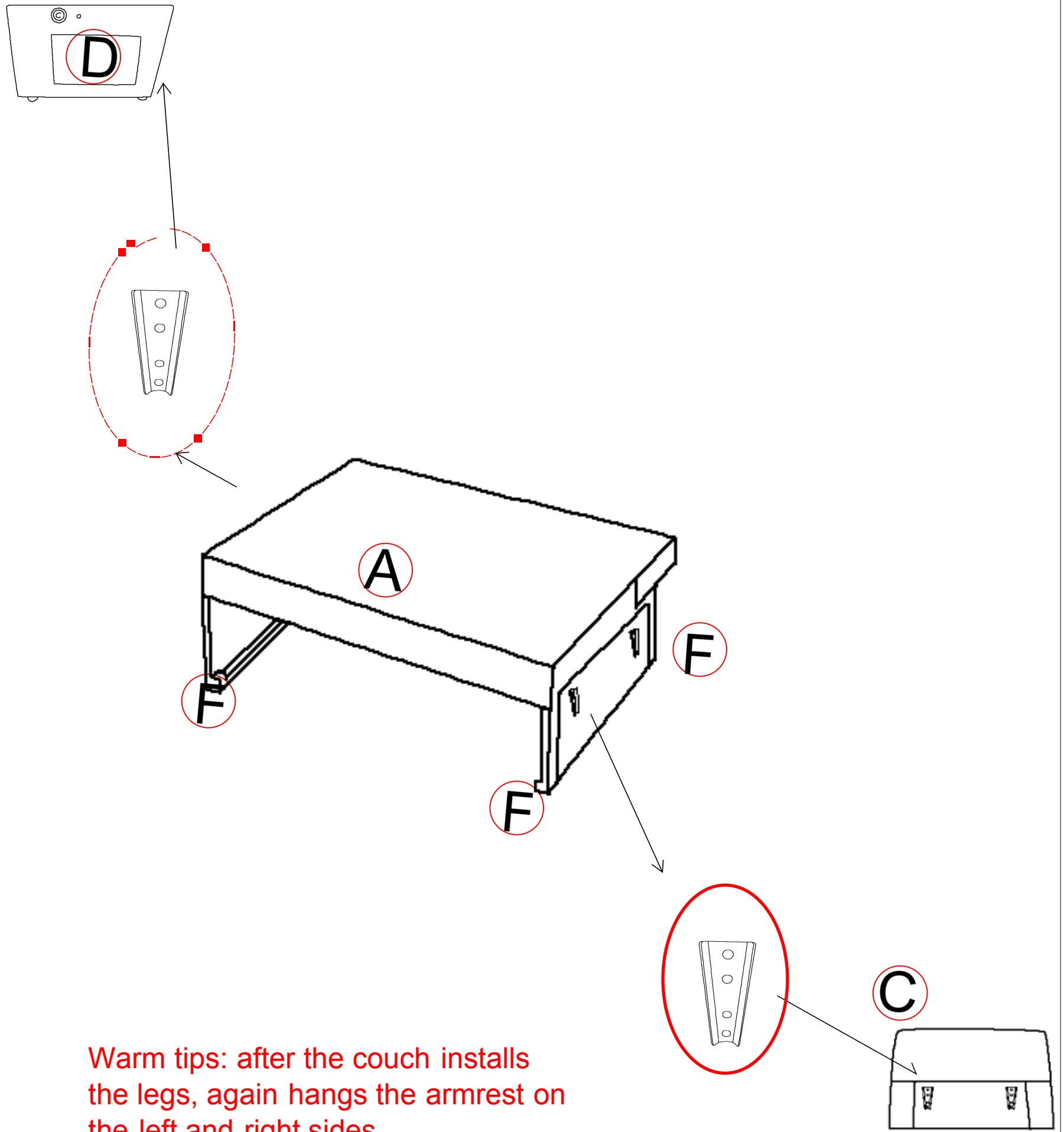

Warm tips: after the couch installs the legs, again hangs the armrest on the left and right sides.

STEP 4

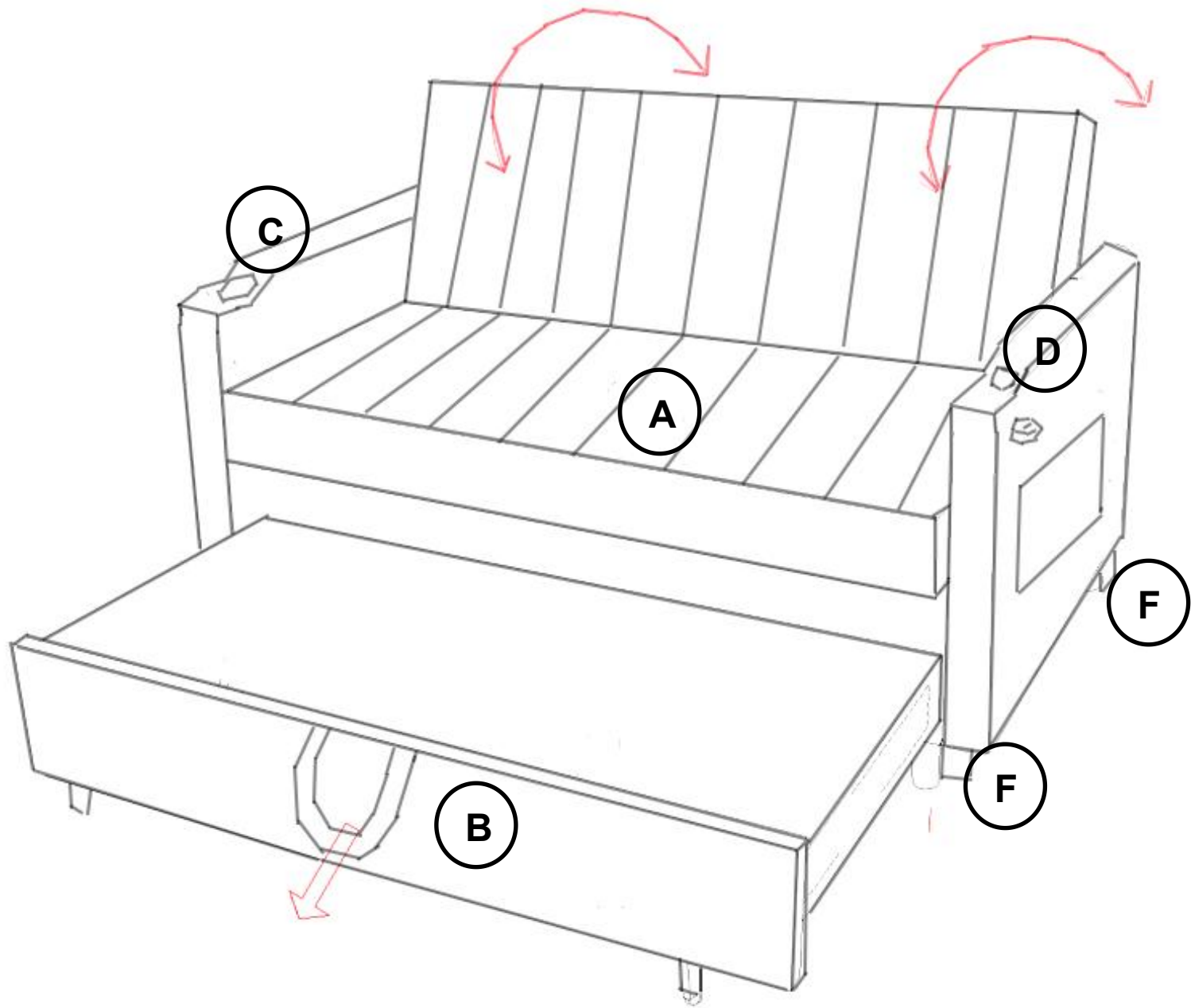

The trundle bed can be pulled out.

STEP 5

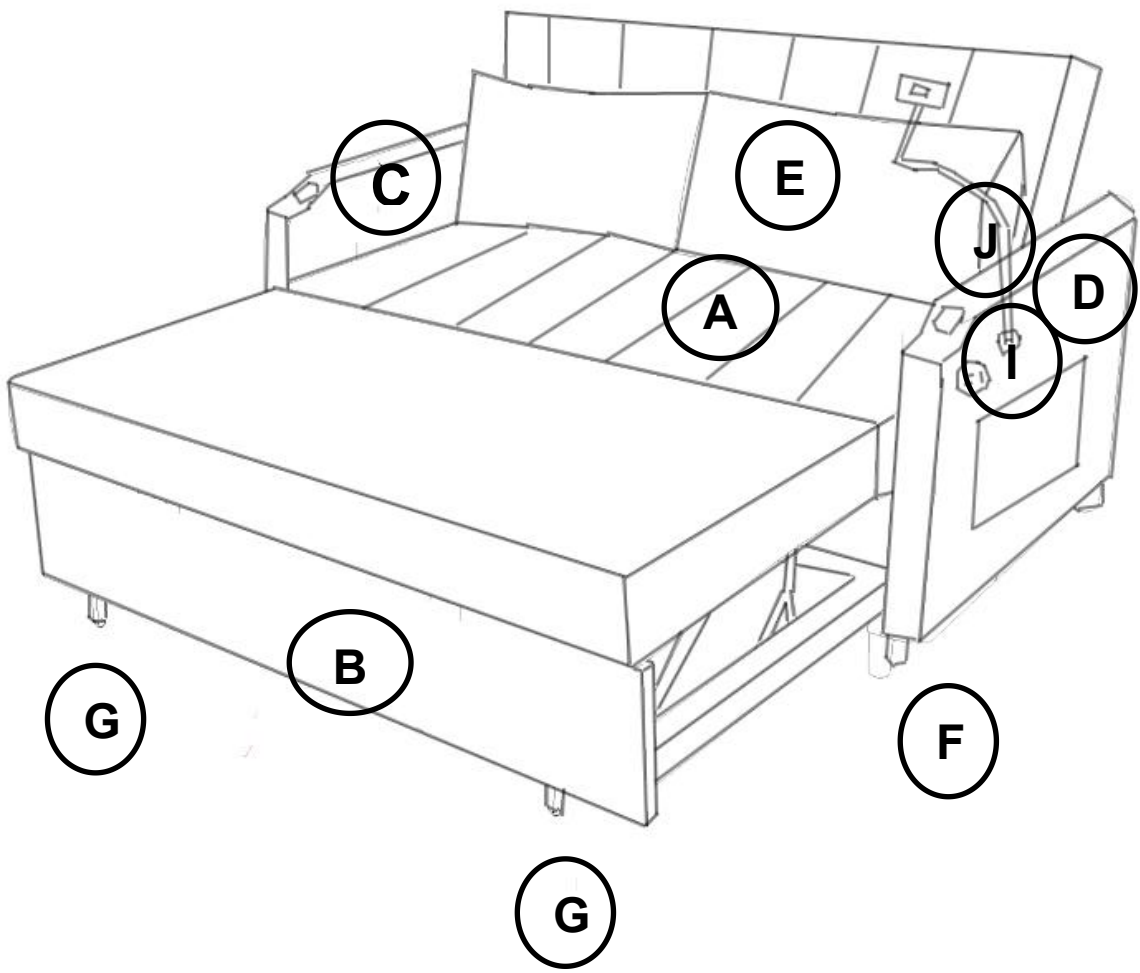
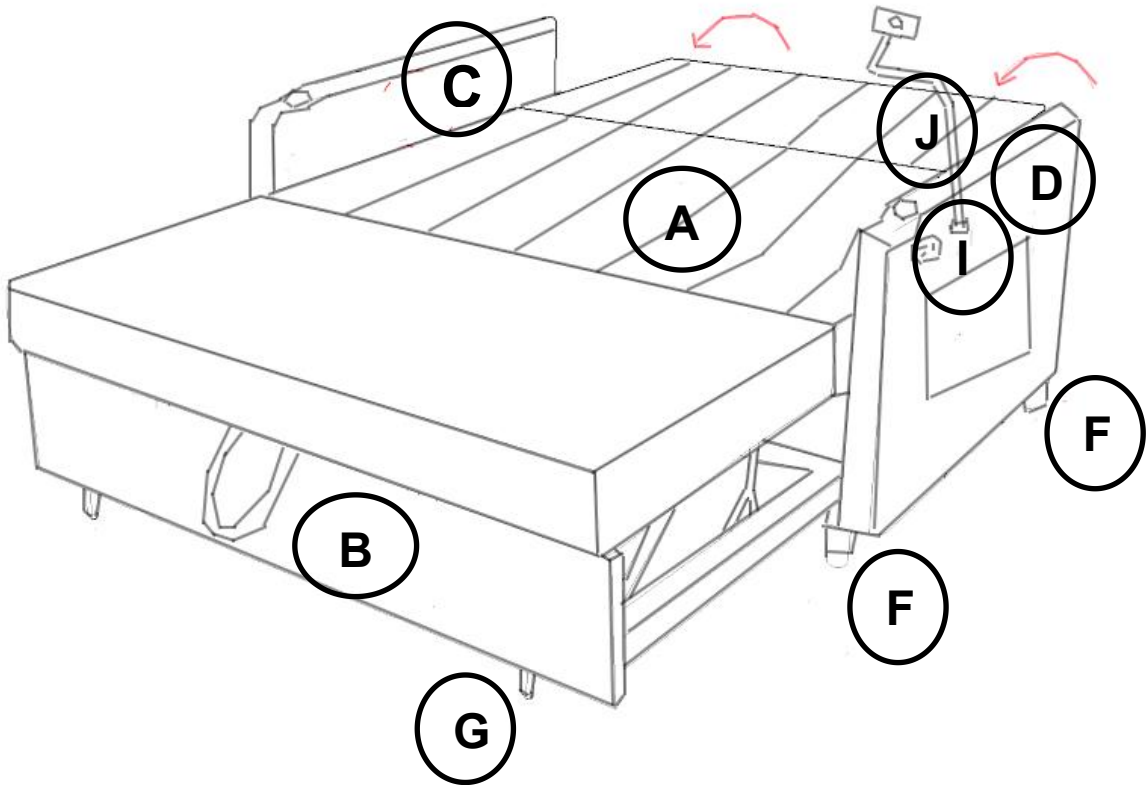

STEP 6

