

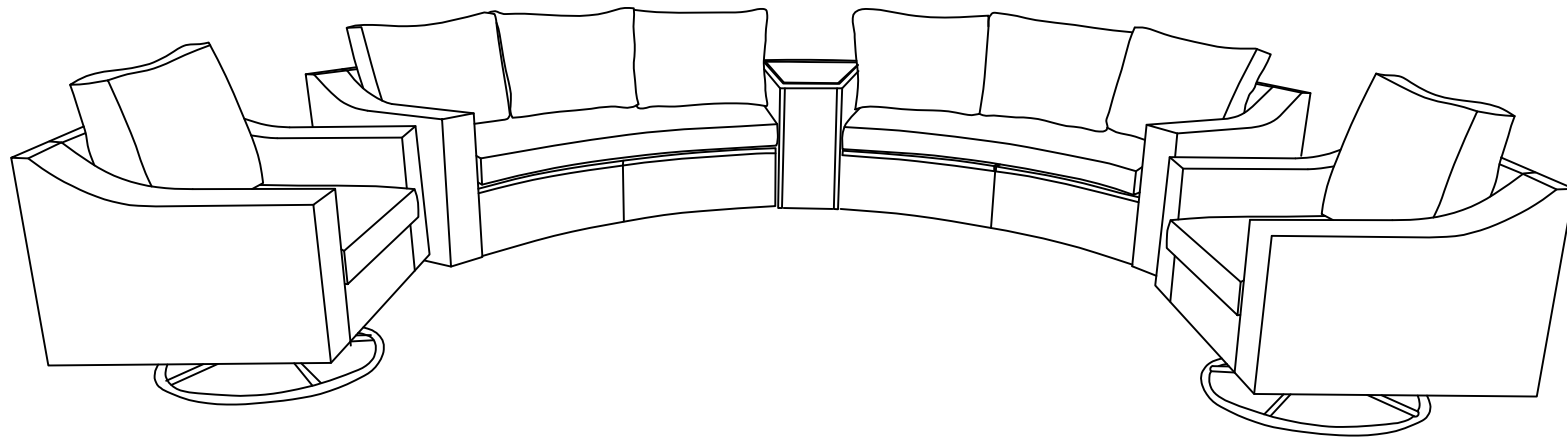







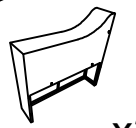
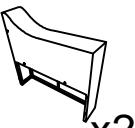
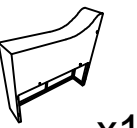
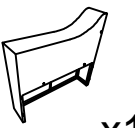
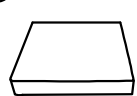

Sofa Assembly Instruction









Dear Customer,

After receiving the product, please check all the accessory codes and quantities according to the instruction manual, if there is any omission, please contact us in time. We will provide solutions for you.

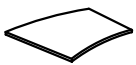
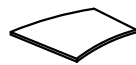
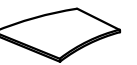





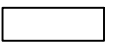



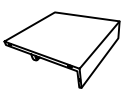
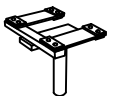
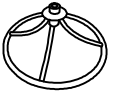

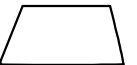
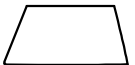
box 1

(A) Right Armrests  x2	(B) Left Armrests  x2	(J) Left Armrests  x1	(T) Right Armrests  x1	(E) Seat cushion  x2	(G) Back cushion  x8	(X) Side panel  x2
(Y) Front panel  x1	(Z) Bottom panel  x1	(a) Door frame  x1	(b) Door panel  x1	(d) Top frame  x1	(e) Glass  x1	(D) Back rest  x2

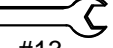
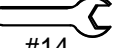
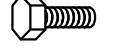
box 2

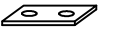
(K) Seat  x2	(L) Seat  x1	(U) Seat  x1	(M) Back rest  x2	(N) Back rest  x1	(V) Back rest  x1	(O) Side panel  x2
(P) Side panel  x1	(W) Side panel  x1	(Q) Side panel  x2				



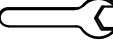

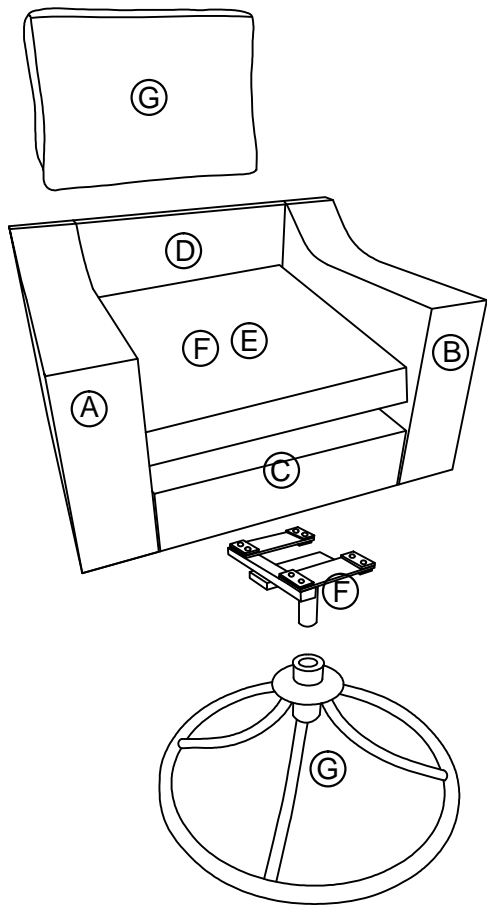

box 3

(C) Seat  x2	(H) 'T'-base  x2	(I) Seat base  x2	(R) Seat cushion  x2	(S) Seat cushion cover  x2	(F) Seat cushion cover  x2	
① Bolt  M6x35 x77	② Washer  x97	③ Allen Key  x1	④ Spanner  #13 x1	⑤ Spanner  #14 x1	⑥ Bolt  M8x40 x8	⑦ Nut  M8 x8
⑧ Elastic Gasket  x8	⑨ Iron Piece  x8	⑩ Bolt  M6x40 x12	⑪ Bolt  M6x55 x4	⑫ Nut  M6 x4	⑬ Spanner  M6 x1	

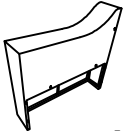
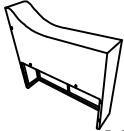
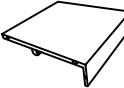

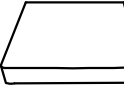

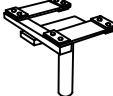

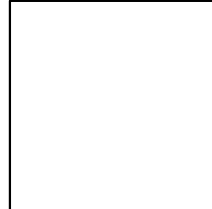

SOFA

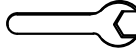
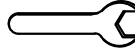

Main structure accessories

<p>(A) Right Armrests</p>  <p>x1</p>	<p>(B) Left Armrests</p>  <p>x1</p>	<p>(C) Seat</p>  <p>x1</p>	<p>(D) Back rest</p>  <p>x1</p>	<p>(E) Seat cushion</p>  <p>x1</p>
<p>(F) Seat cushion cover</p>  <p>x1</p>	<p>(G) Back cushion</p>  <p>x1</p>	<p>(H) 'T'-base</p>  <p>x1</p>	<p>(I) Seat base</p>  <p>x1</p>	





Hardware parts

<p>(1) Bolt</p>  <p>M6x35</p> <p>x4</p>	<p>(2) Washer</p>  <p>x10</p>	<p>(3) Allen Key</p>  <p>x1</p>	<p>(4) Spanner</p>  <p>#13</p> <p>x1</p>	<p>(5) Spanner</p>  <p>#14</p> <p>x1</p>
<p>(6) Bolt</p>  <p>M8x40</p> <p>x4</p>	<p>(7) Washer</p>  <p>x4</p>	<p>(8) Elastic Gasket</p>  <p>x4</p>	<p>(9) Iron Piece</p>  <p>x4</p>	<p>(10) Bolt</p>  <p>M6x40</p> <p>x6</p>

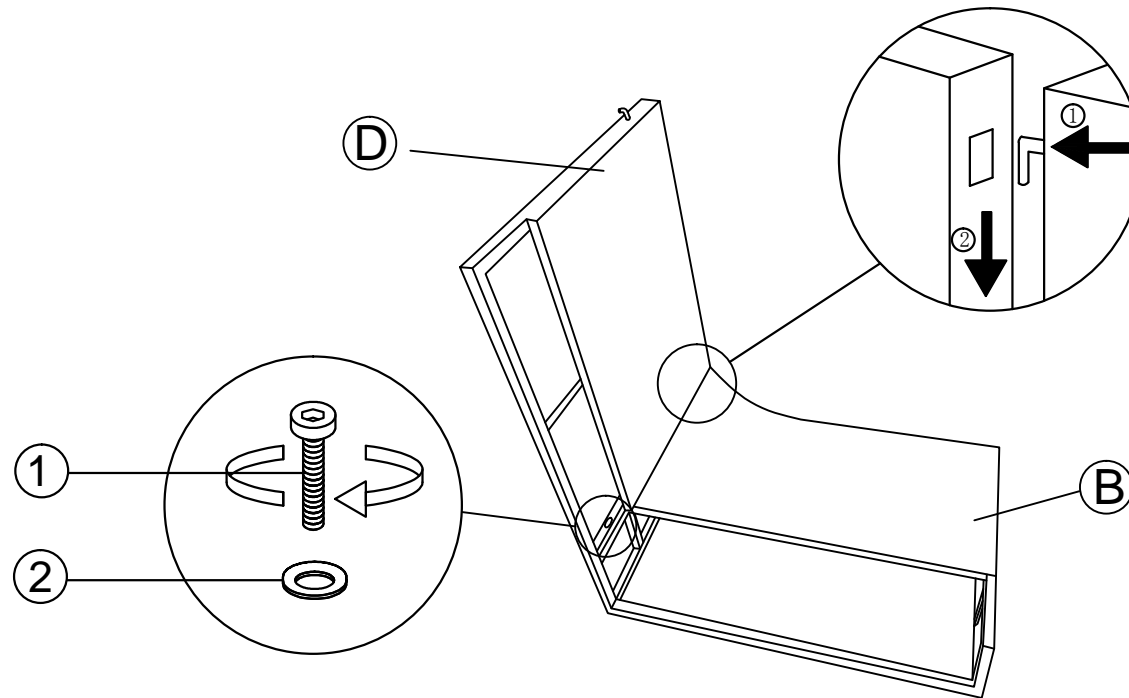
Assembly Instruction

STEP1

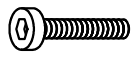

B Left Armrests  x1	D Back rest  x1	1 Bolt  M6x35 x1	2 Washer  x1
---	---	---	--

Place the Armrests on the ground before assemble.
Please DO NOT tighten the screws at this step yet. Wait to tighten all the screws until the product is fully installed.

Assembly Instruction

STEP 2

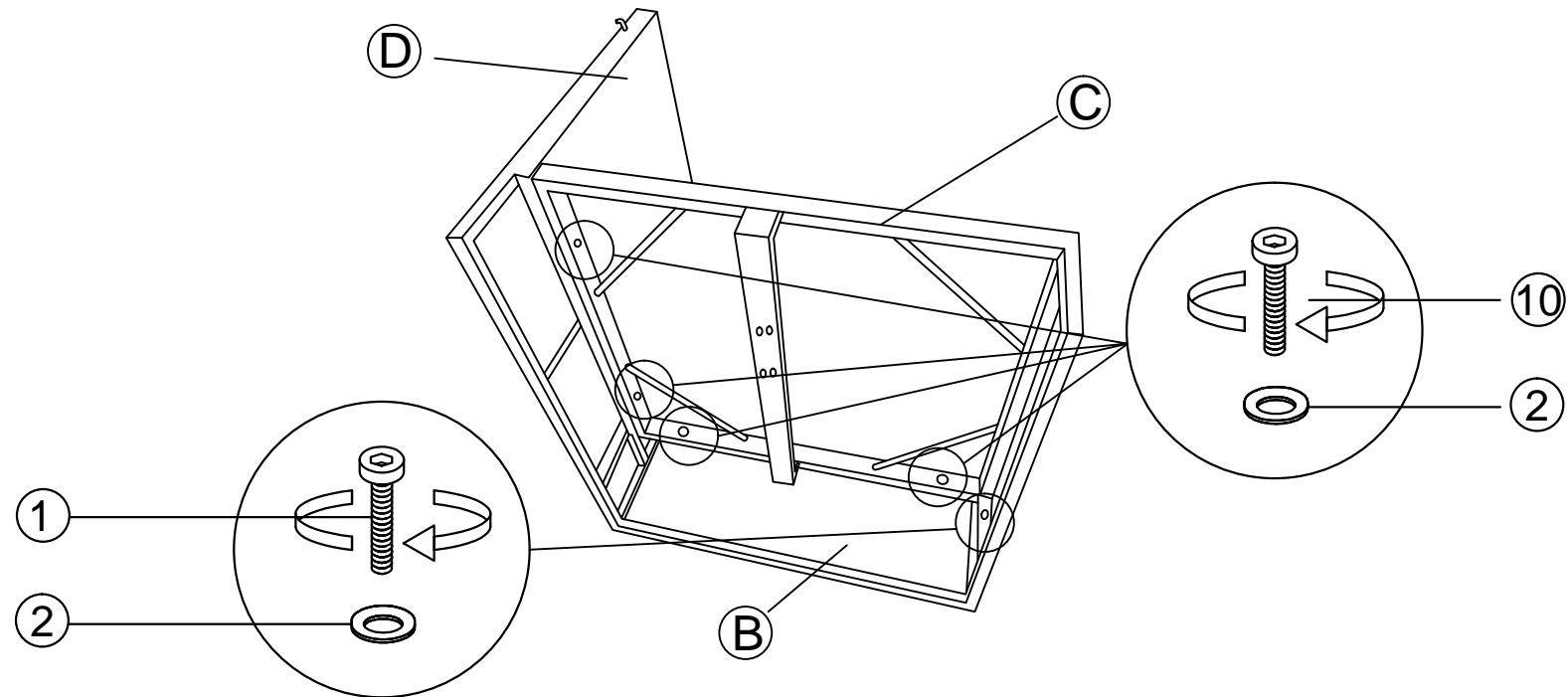





© Seat x1	① Bolt M6x35 x1	⑩ Bolt M6x40 x4	② Washer x6
--------------	-----------------------	-----------------------	----------------

Please DO NOT tighten the screws at this step yet. Wait to tighten all the screws until the product is fully installed.

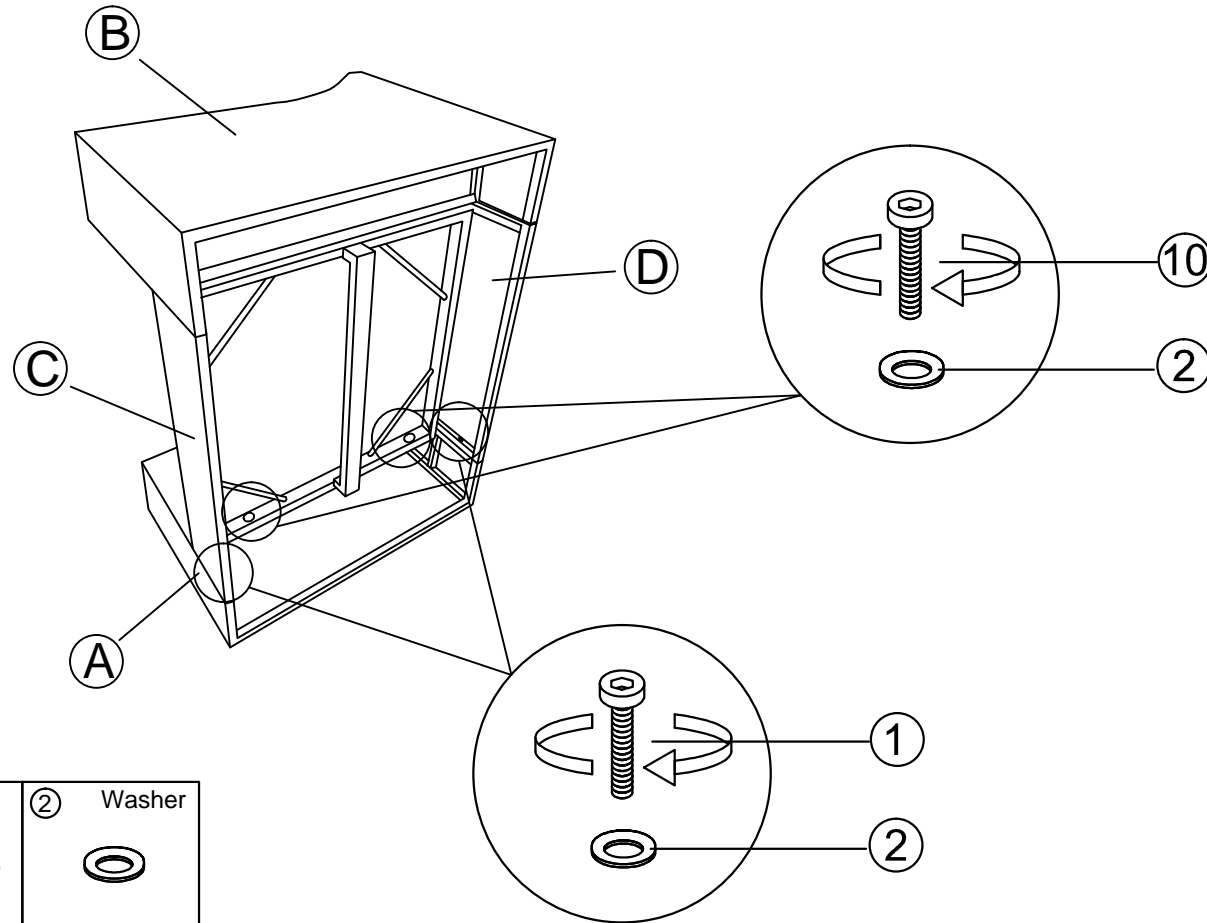
Assembly Instruction

STEP3

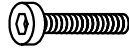

(A) Right Armrests	(1) Bolt	(10) Bolt	(2) Washer
			
x1	M6x35 x2	M6x40 x2	x4

Lock the screws in this step .

Assembly Instruction

STEP4

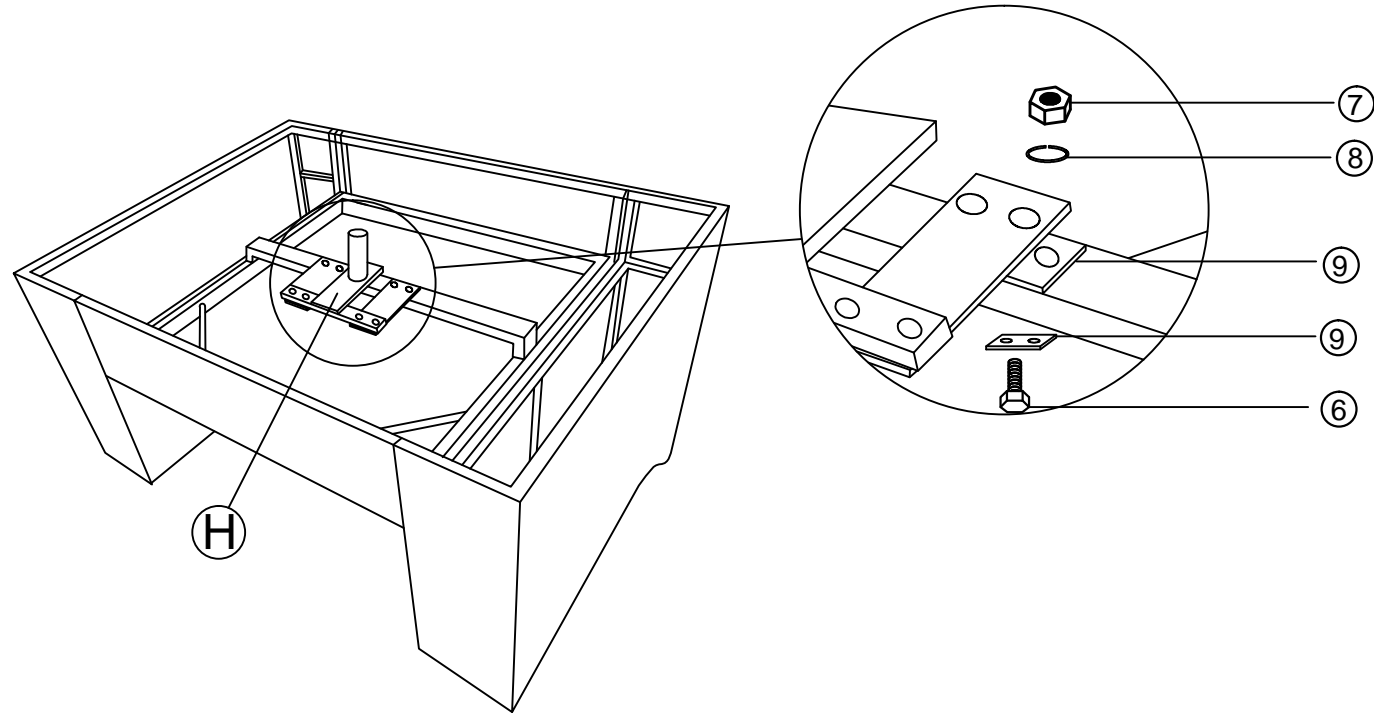

⑥ Bolt M8x40 x4	⑦ Washer x4	⑧ Elastic Gasket x4	⑨ Iron Piece x4	④ Spanner #13 x1	⑤ Spanner #14 x1	⑨ 'T'-base x1
-----------------------	----------------	------------------------	--------------------	------------------------	------------------------	------------------

Lock the screws in this step .

Assembly Instruction

STEP5

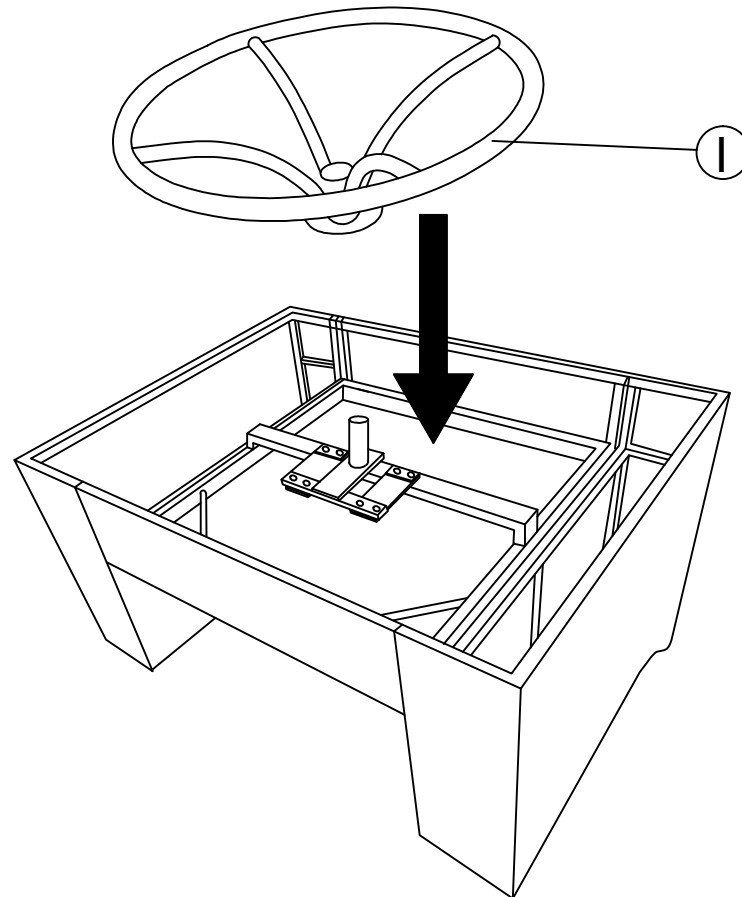

① Seat base

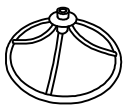

x1

Assembly Instruction

STEP 6

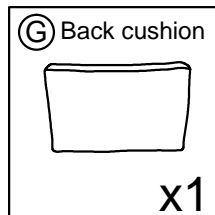
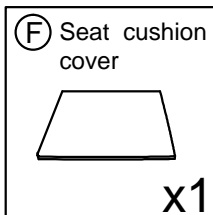
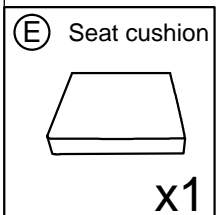
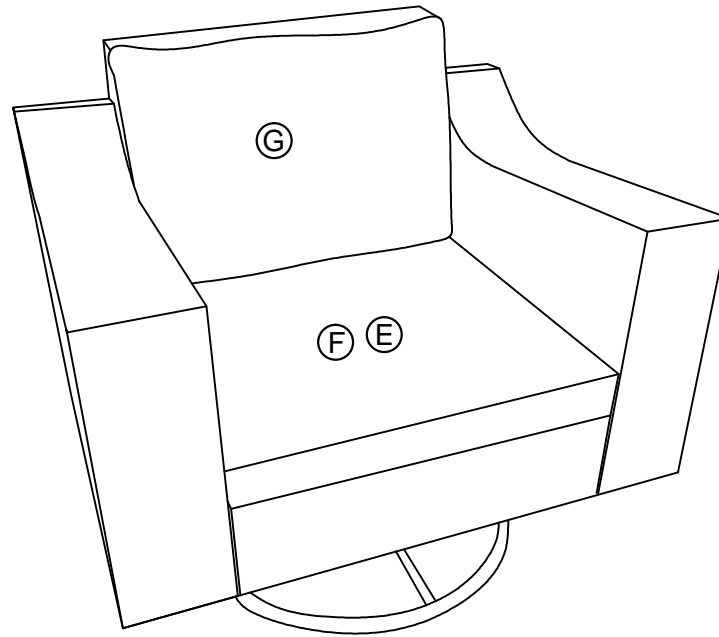

RIGHT SOFA

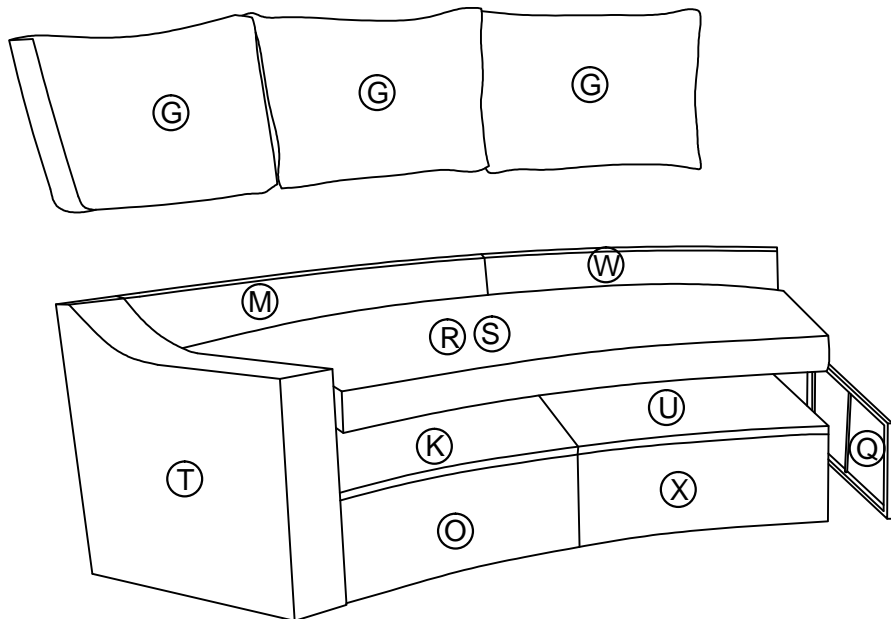

Main structure accessories

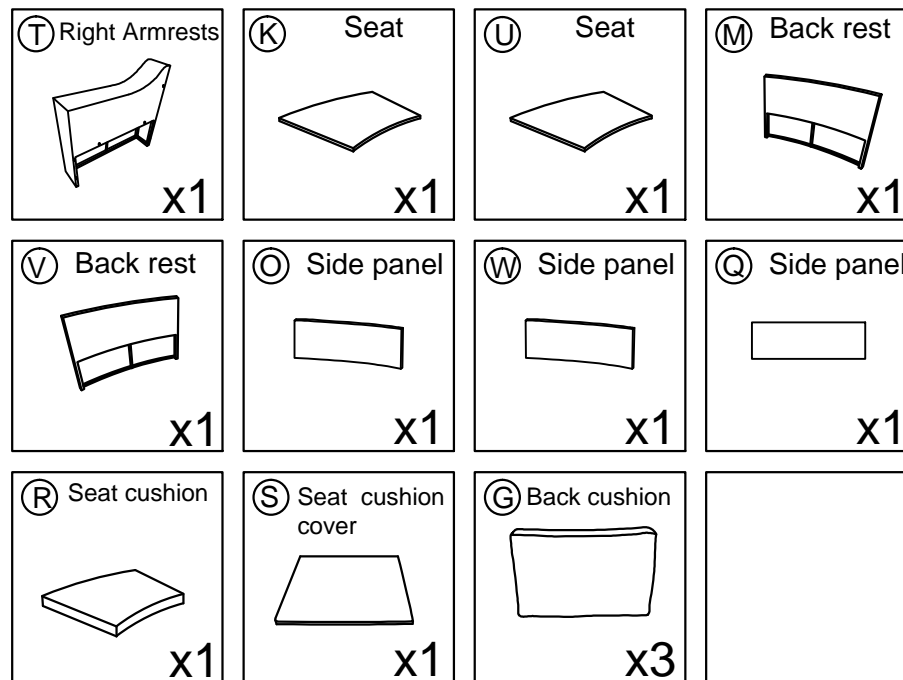

Hardware parts

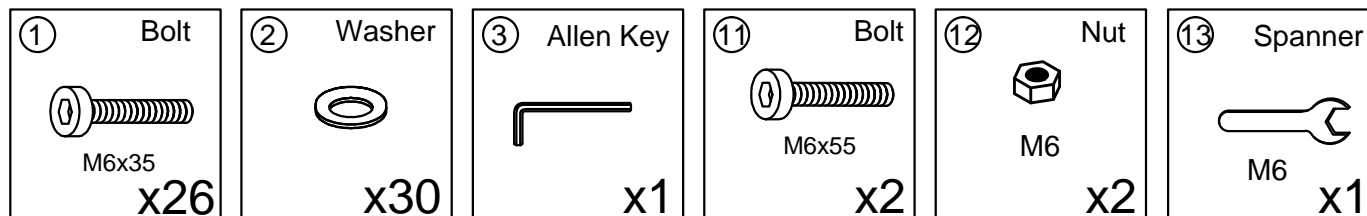

Assembly Instruction

STEP1

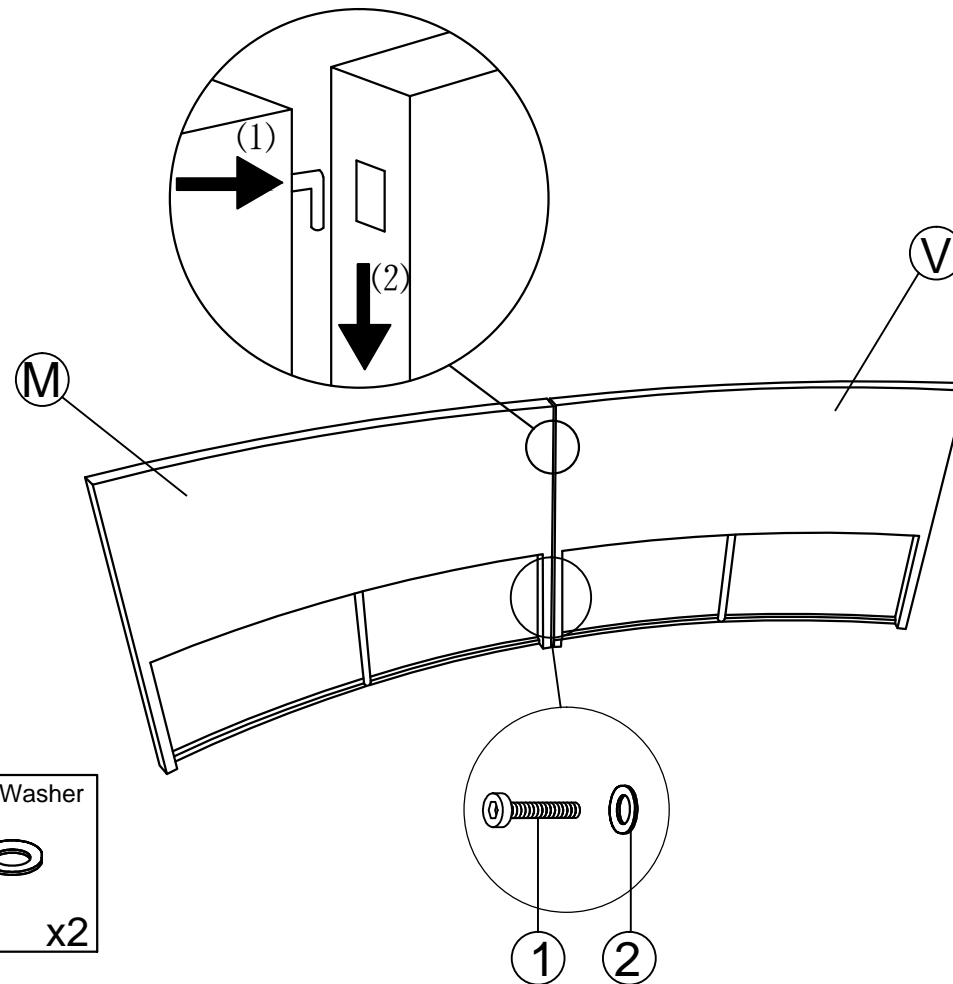



Please DO NOT tighten the screws at this step yet. Wait to tighten all the screws until the product is fully installed.

Assembly Instruction

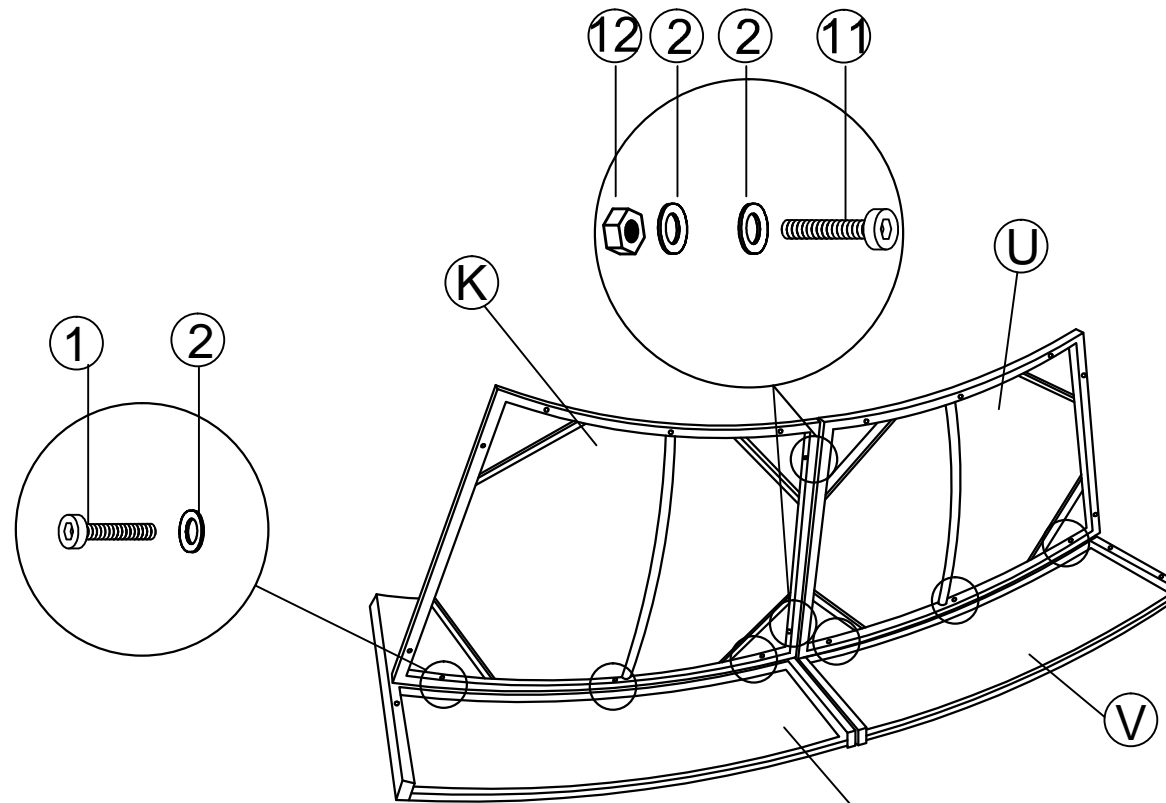
STEP 2

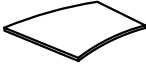
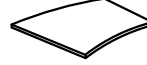
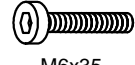
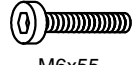

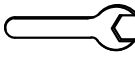
(K) Seat	(U) Seat	(1) Bolt M6x35 x6	(11) Bolt M6x55 x2	(12) Nut M6 x2	(2) Washer x10	(13) Spanner x1
						

Please DO NOT tighten the screws at this step yet. Wait to tighten all the screws until the product is fully installed.

Assembly Instruction

STEP3

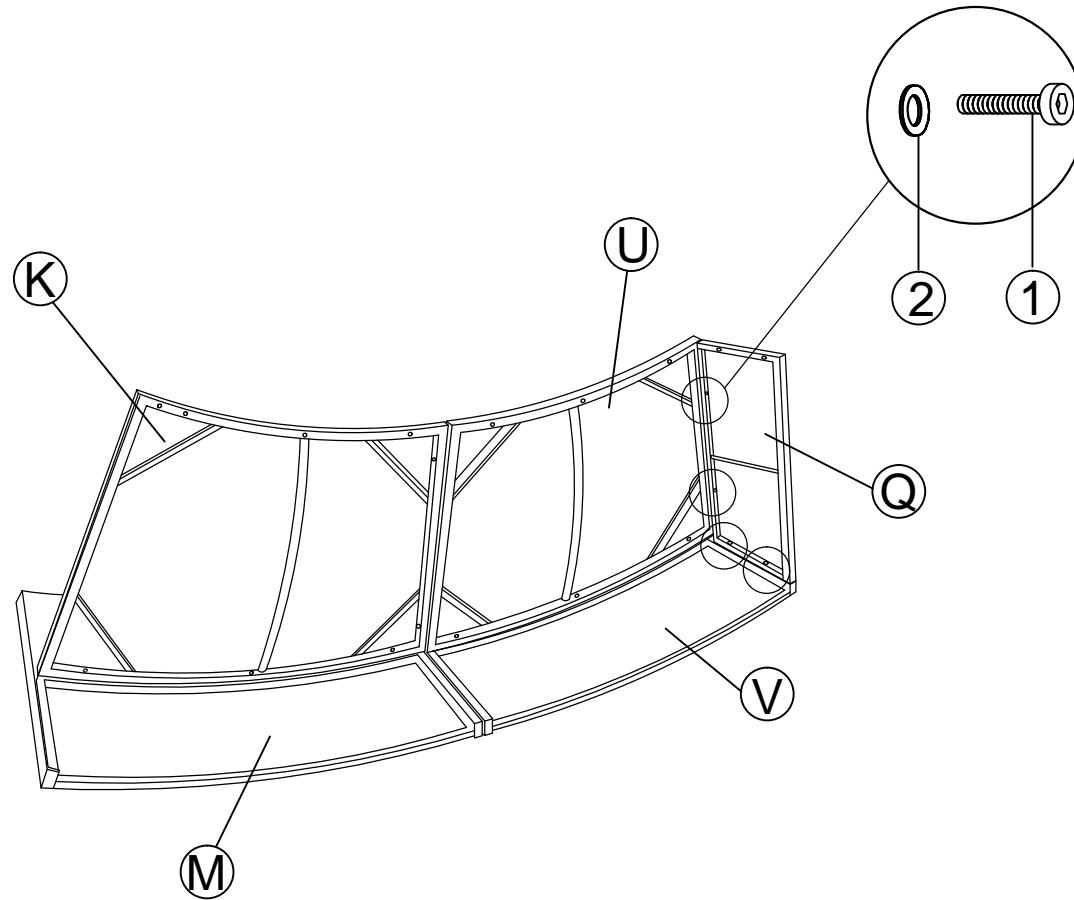





Q Side panel x1	1 Bolt M6x35 x4	2 Washer x4
--------------------	-----------------------	----------------

Please DO NOT tighten the screws at this step yet. Wait to tighten all the screws until the product is fully installed.

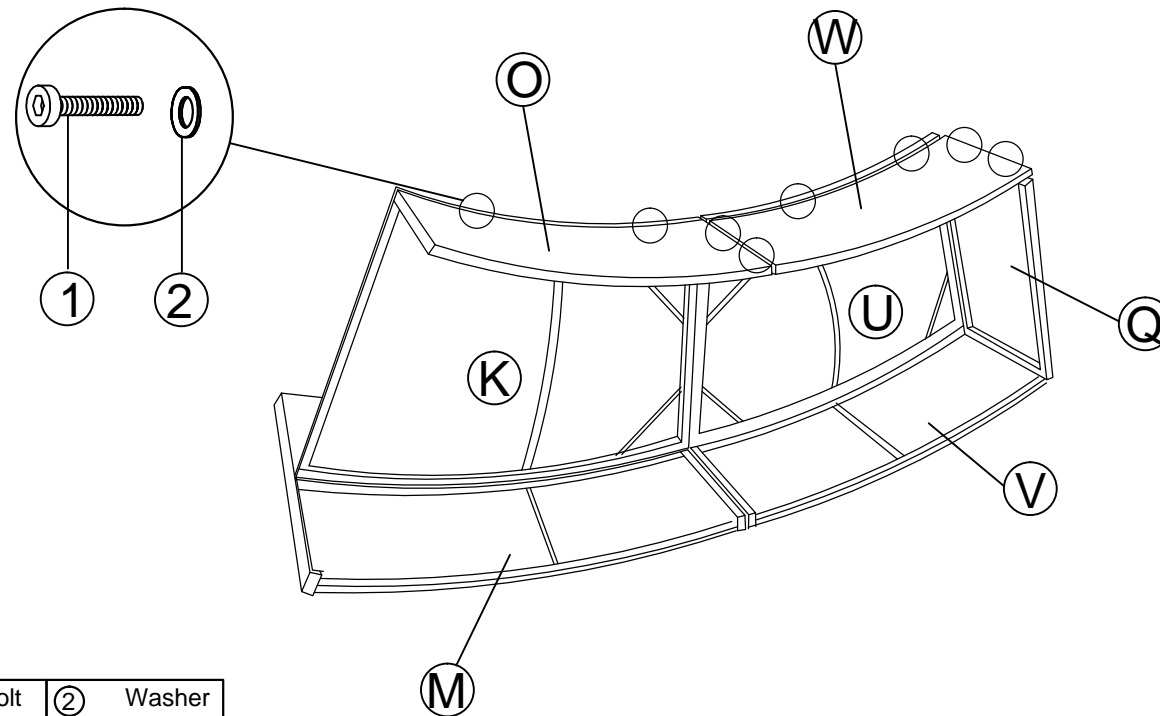
Assembly Instruction

STEP4





ⓐ Side panel	Ⓦ Side panel	① Bolt	② Washer
			
x1	x1	M6x35 x8	x8

Please DO NOT tighten the screws at this step yet. Wait to tighten all the screws until the product is fully installed.

Assembly Instruction

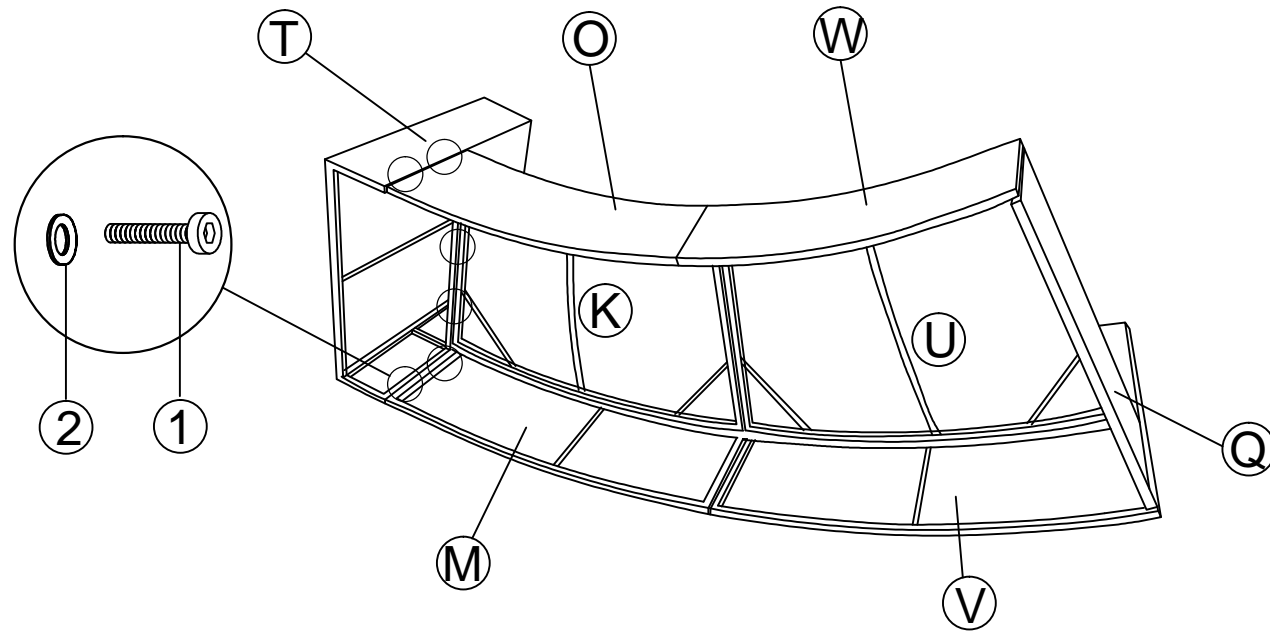
STEP5

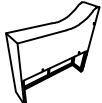





Ⓣ Left Armrests  x1	① Bolt  M6x35 x6	② Washer  x6
--	--	---

Lock the screws in this step .

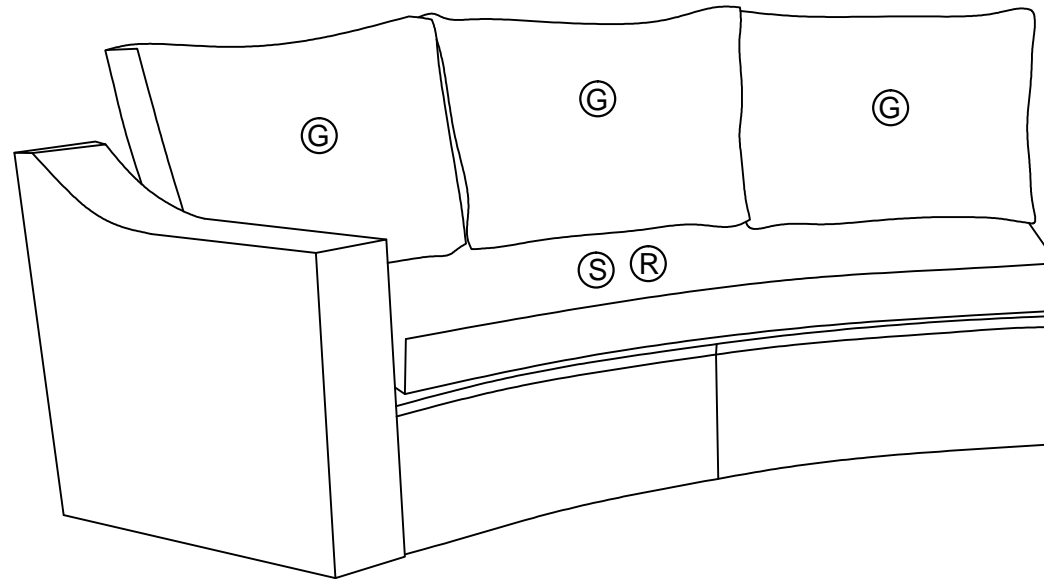
Assembly Instruction

STEP 6



 Ⓡ Seat cushion x1	 Ⓢ Seat cushion cover x1	 ⓐ Back cushion x3
---	---	---

LEFT SOFA

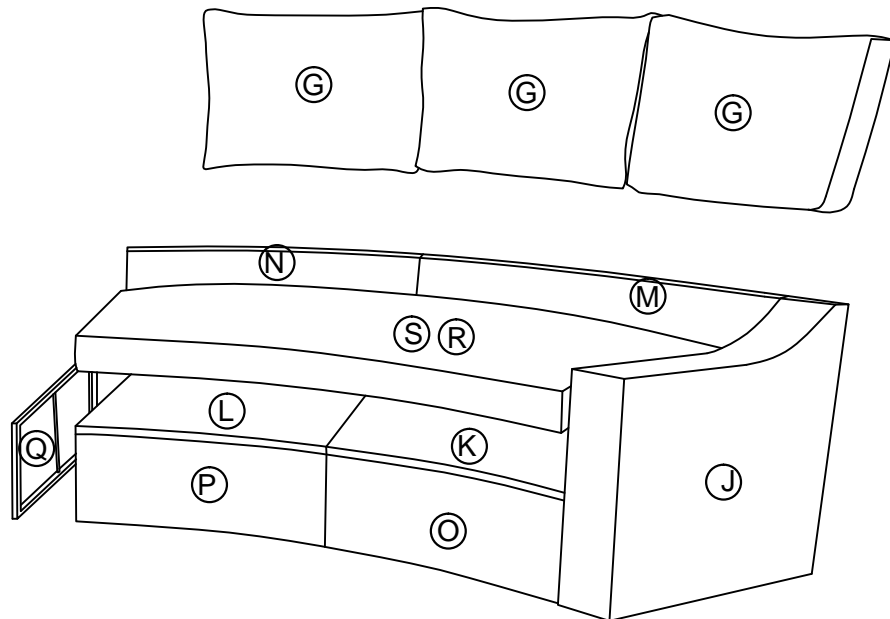

Main structure accessories

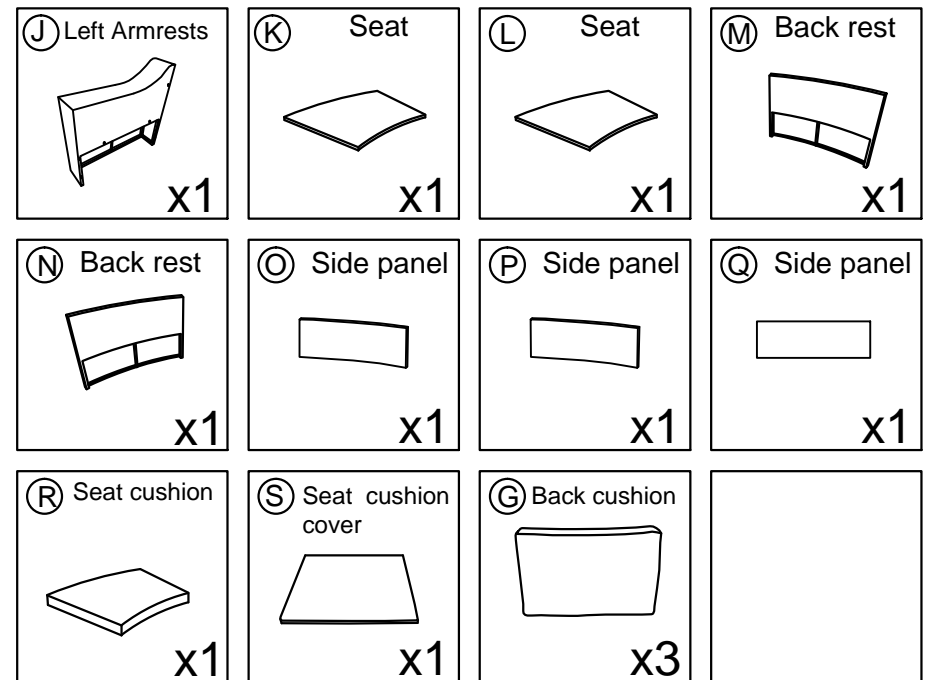

Hardware parts

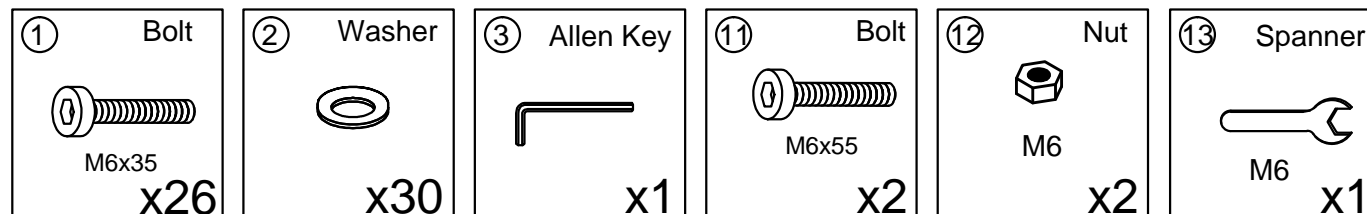

Assembly Instruction

STEP1

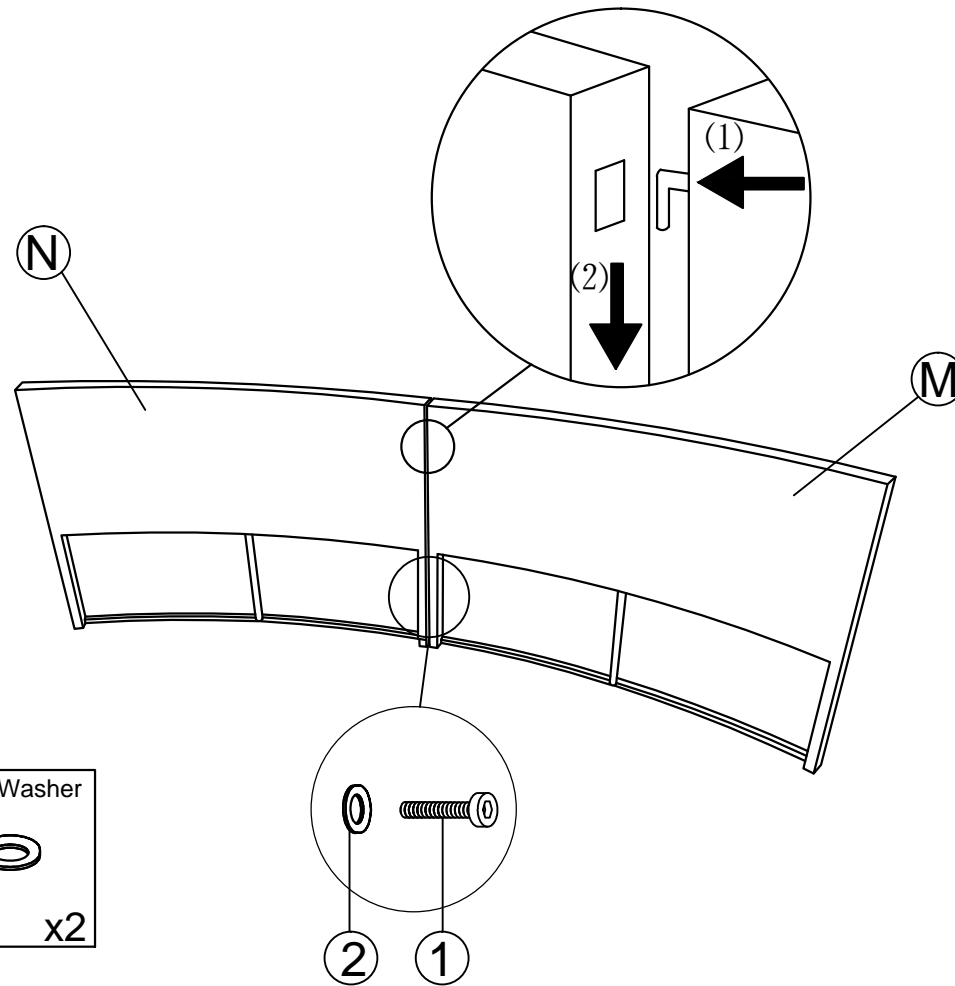





(M) Back rest x1	(N) Back rest x1	(1) Bolt M6x35 x2	(2) Washer x2
---------------------	---------------------	-------------------------	------------------

Please DO NOT tighten the screws at this step yet. Wait to tighten all the screws until the product is fully installed.

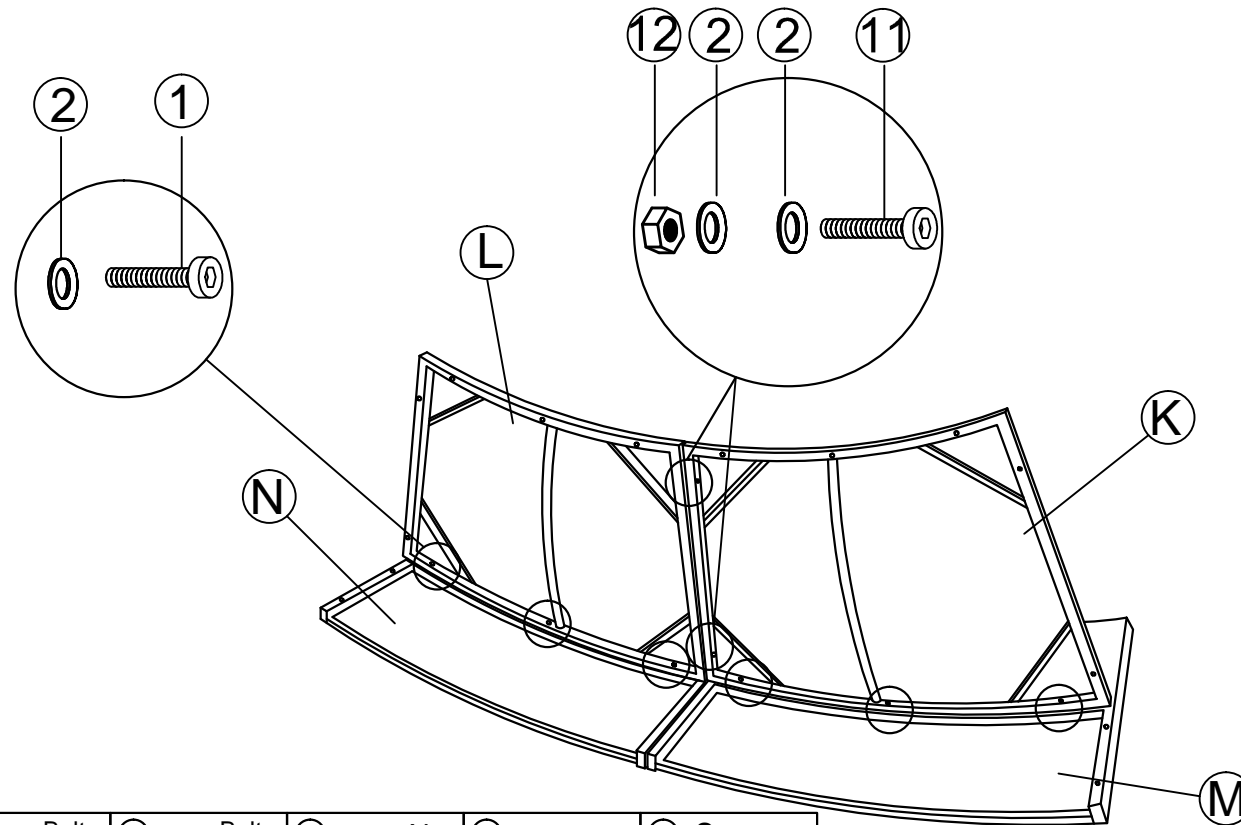
Assembly Instruction

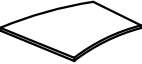
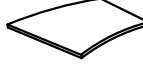
STEP2

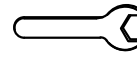

Ⓚ Seat  x1	Ⓛ Seat  x1	① Bolt  M6x35 x6	⑪ Bolt  M6x55 x2	⑫ Nut  M6 x2	② Washer  x10	⑬ Spanner  x1
---	---	--	--	--	--	--



Please DO NOT tighten the screws at this step yet. Wait to tighten all the screws until the product is fully installed.

M6

Assembly Instruction

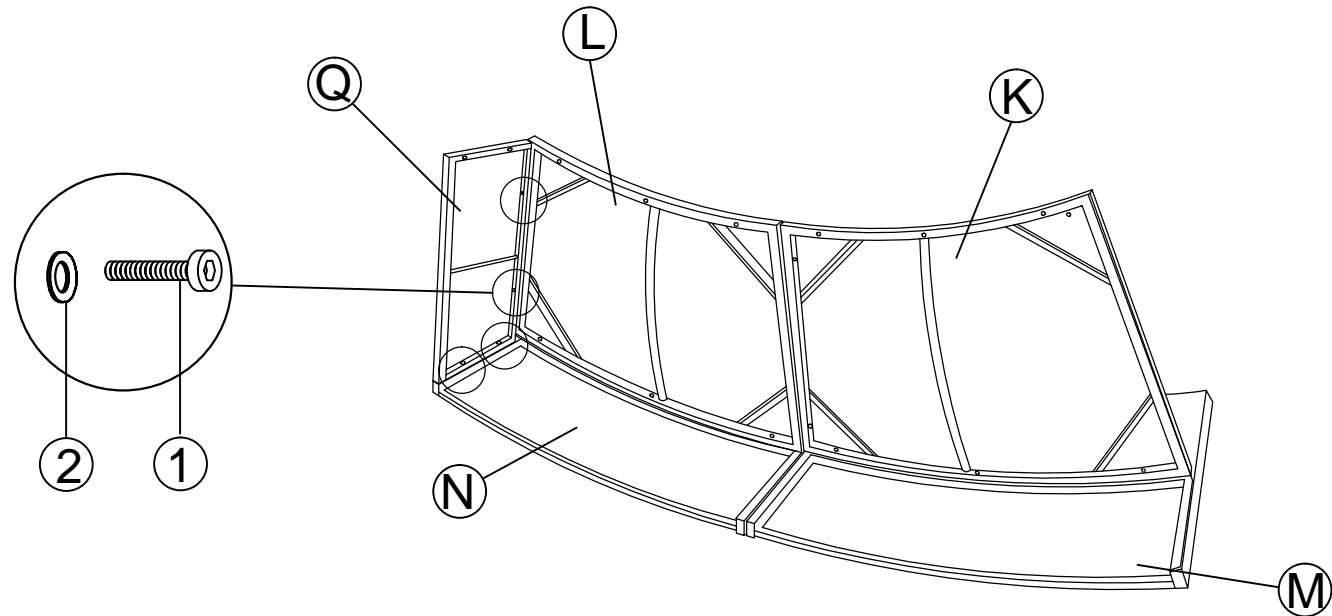
STEP 3

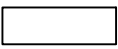





Q Side panel	1 Bolt	2 Washer
		
x1	M6x35 x4	x4

Please DO NOT tighten the screws at this step yet. Wait to tighten all the screws until the product is fully installed.

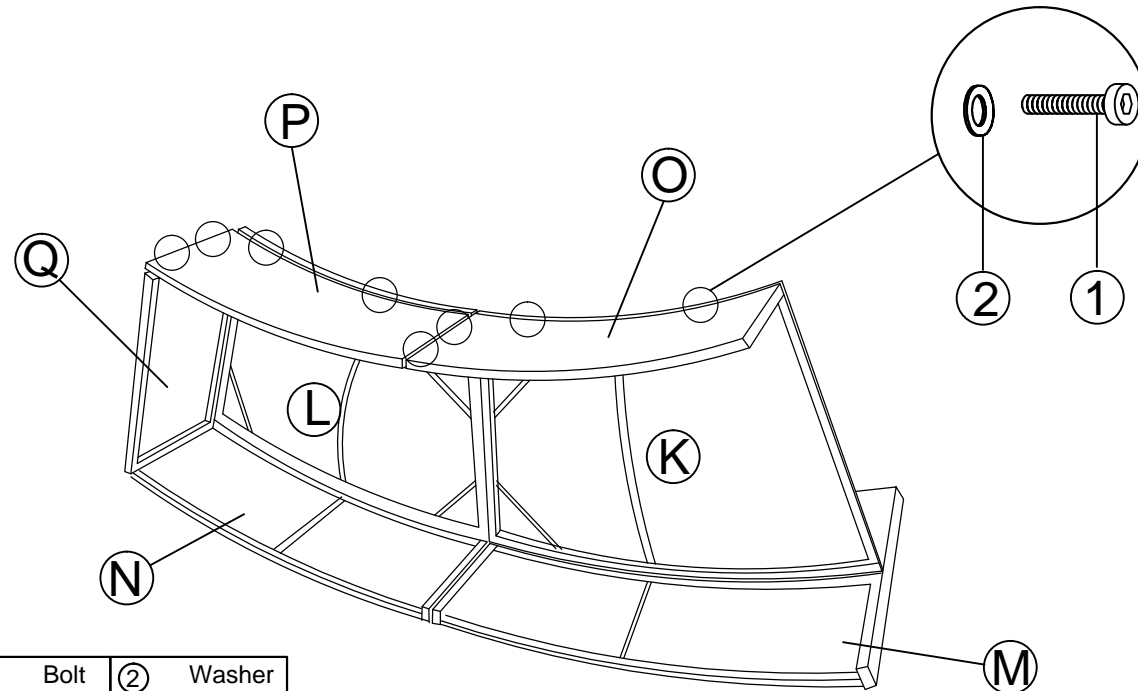
Assembly Instruction

STEP 4







Ⓞ Side panel	Ⓟ Side panel	① Bolt	② Washer
			
x1	x1	M6x35 x8	x8

Please DO NOT tighten the screws at this step yet. Wait to tighten all the screws until the product is fully installed.

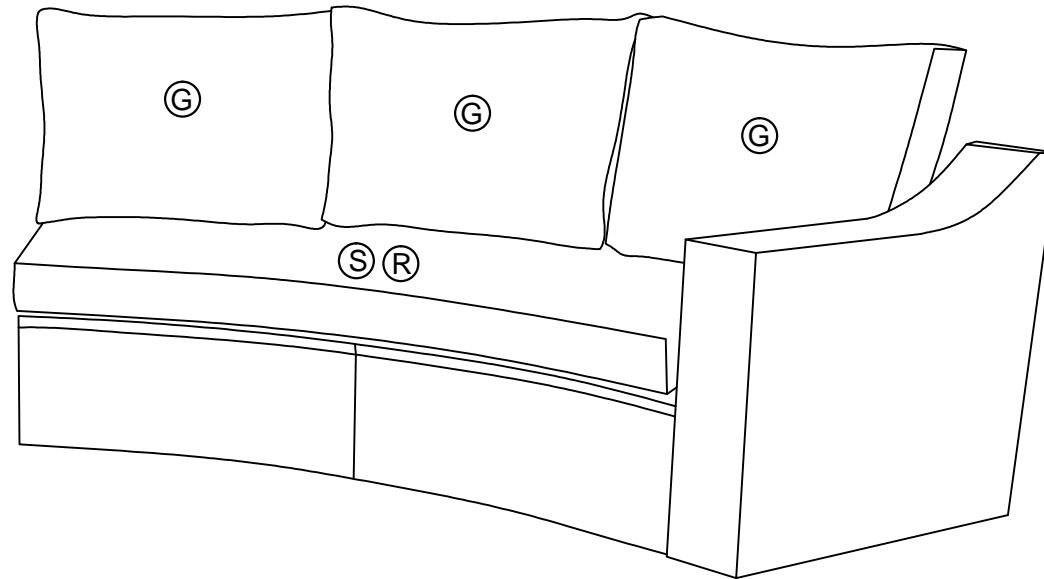
Assembly Instruction

STEP 6

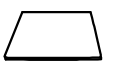

 Ⓡ Seat cushion x1	 Ⓢ Seat cushion cover x1	 ⓐ Back cushion x3
---	---	---

SOFA

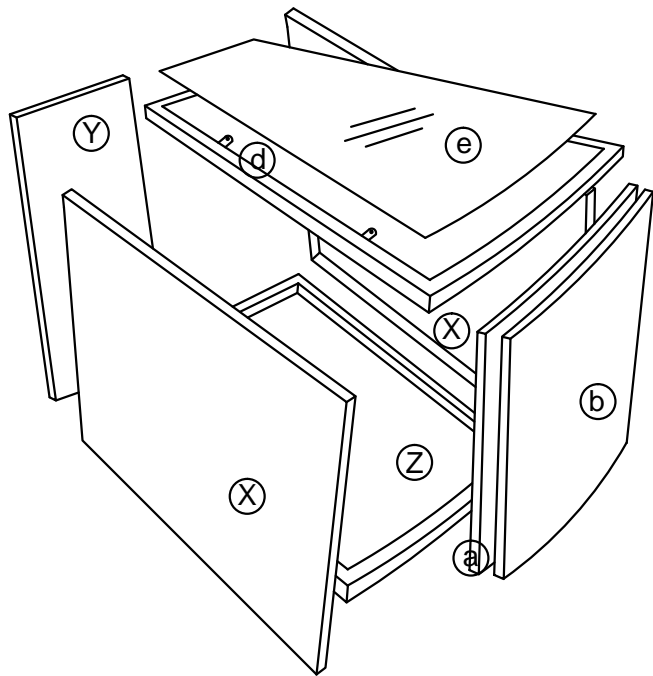

Main structure accessories

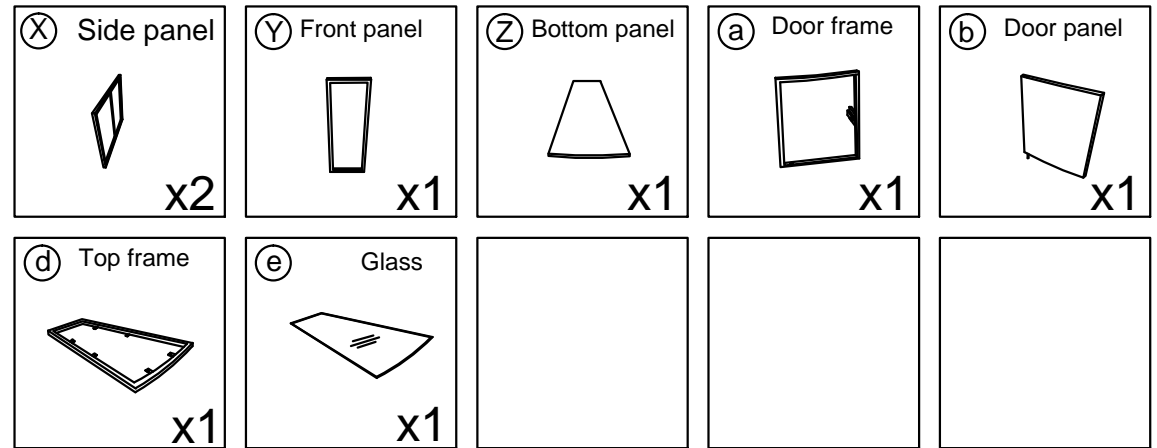



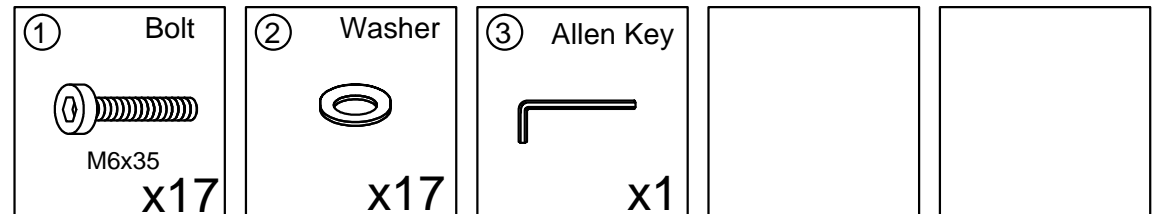

Hardware parts

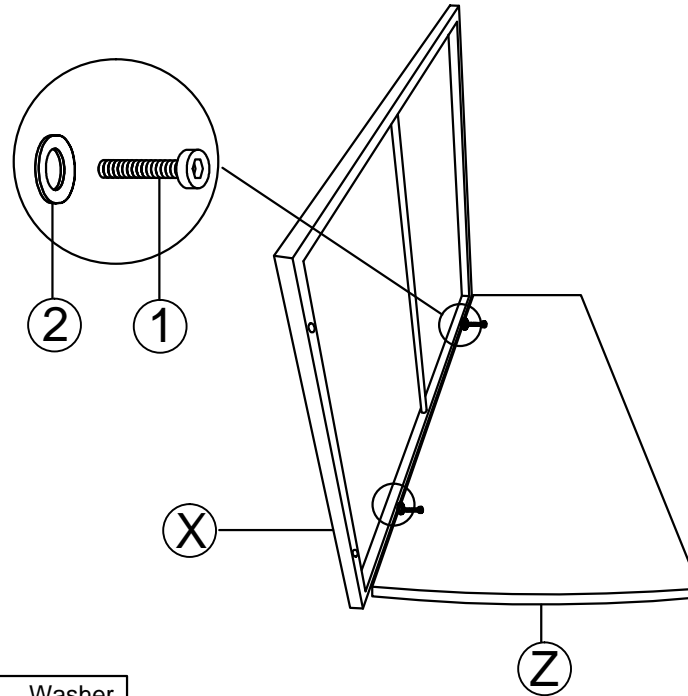

Assembly Instruction

STEP1

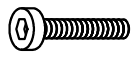





⊗ Side panel	⓪ Bottom panel	① Bolt	② Washer
		 M6x35	
x1	x1	x2	x2

Please DO NOT tighten the screws at this step yet. Wait to tighten all the screws until the product is fully installed.

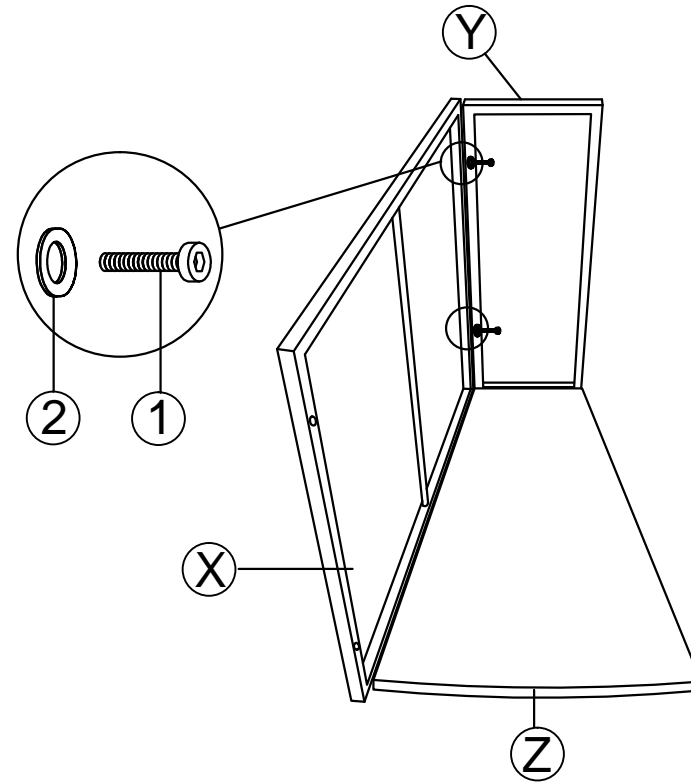
Assembly Instruction

STEP 2







Y Front panel  x1	1 Bolt  M6x35 x2	2 Washer  x2
--	--	---

Please DO NOT tighten the screws at this step yet. Wait to tighten all the screws until the product is fully installed.

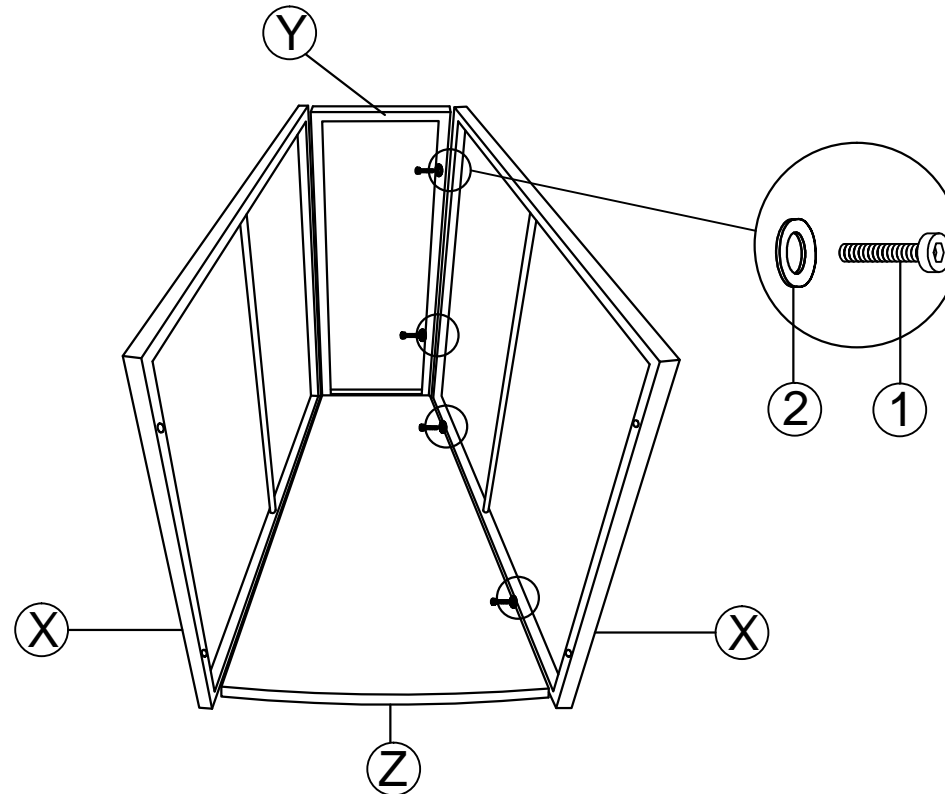
Assembly Instruction

STEP 3

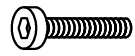





⊗ Side panel	① Bolt	② Washer
 x1	 M6x35 x4	 x4

Please DO NOT tighten the screws at this step yet. Wait to tighten all the screws until the product is fully installed.

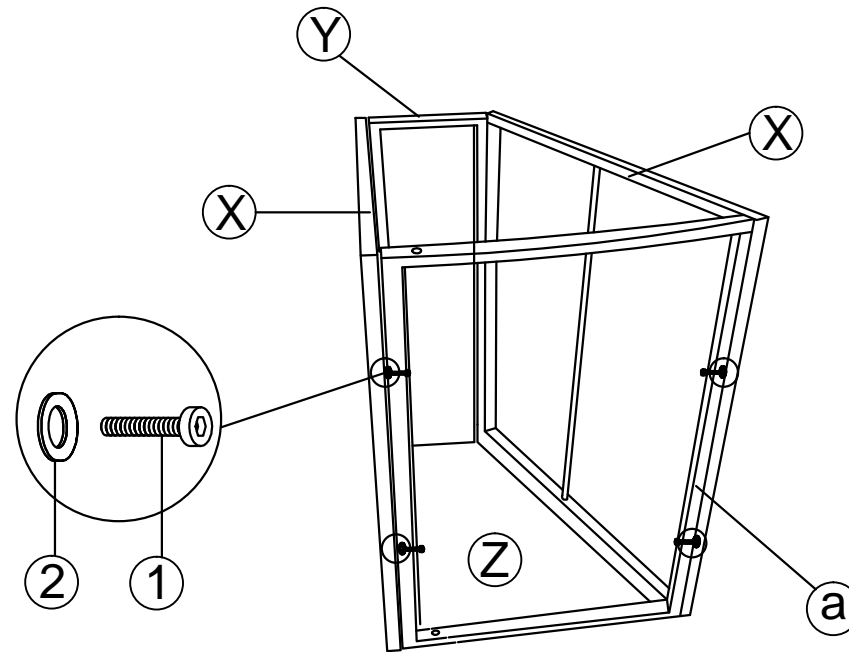
Assembly Instruction

STEP 4

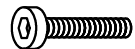





a Door frame  x1	1 Bolt  M6x35 x4	2 Washer  x4
--	---	--

Please DO NOT tighten the screws at this step yet. Wait to tighten all the screws until the product is fully installed.

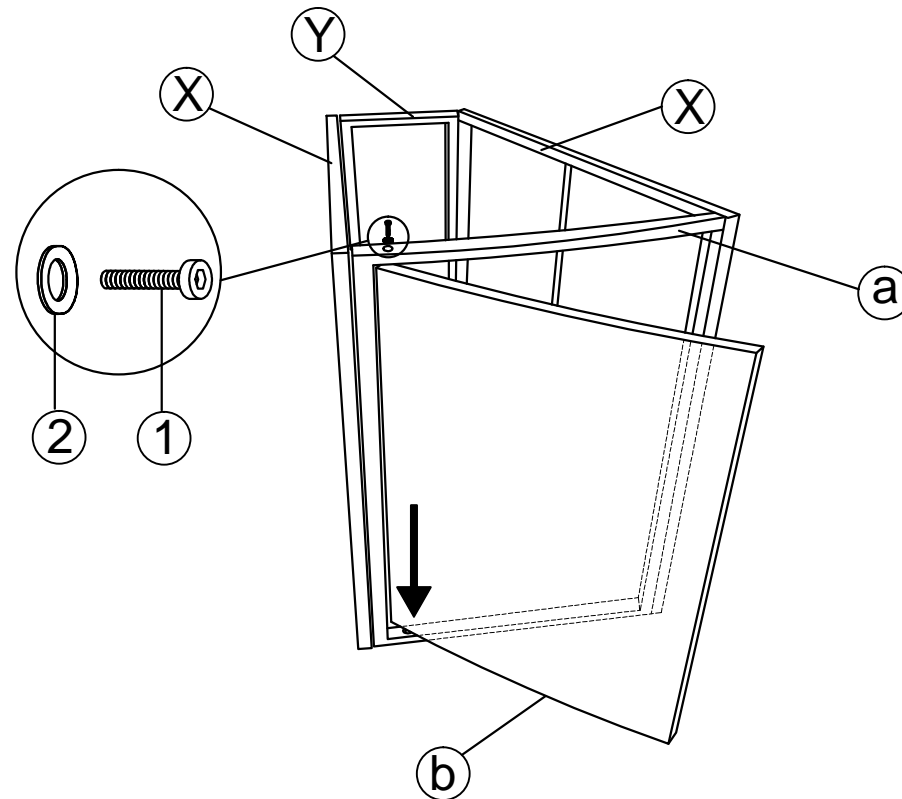
Assembly Instruction

STEP5







(b) Door panel  x1	(1) Bolt  M6x35 x1	(2) Washer  x1
---	--	---

Please DO NOT tighten the screws at this step yet. Wait to tighten all the screws until the product is fully installed.

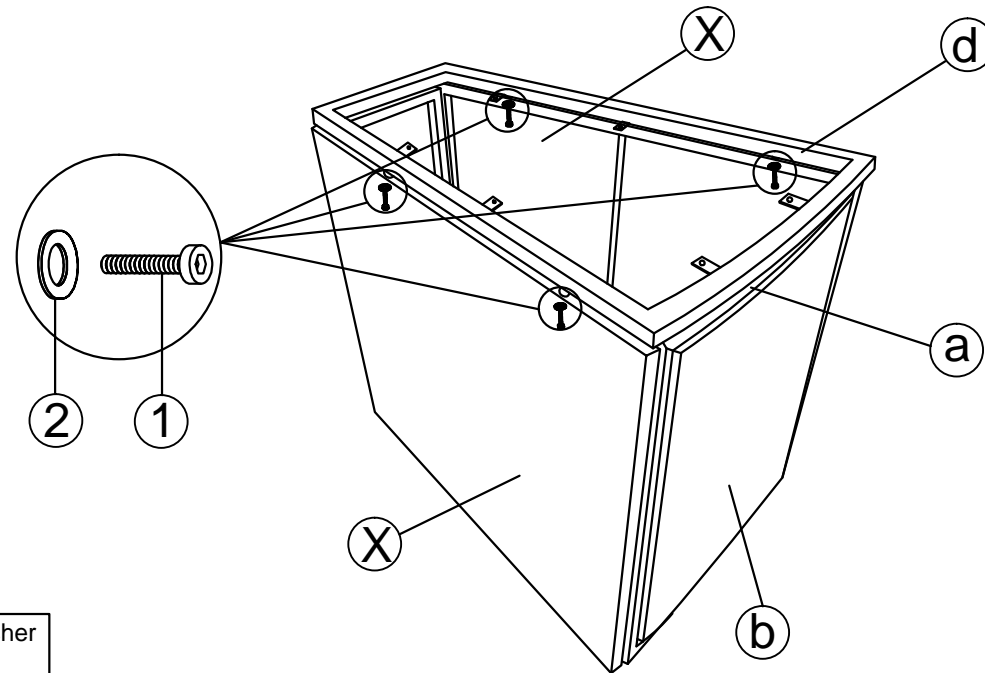
Assembly Instruction

STEP 6



d Top frame	1 Bolt	2 Washer
	 M6x35	
x1	x4	x4

Lock the screws in this step .

Assembly Instruction

STEP7

