















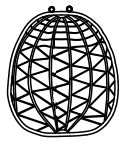

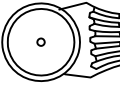

ASSEMBLY INSTRUCTION

<p>A</p>  <p>X1</p>	<p>B</p>  <p>X4</p>	<p>C</p>  <p>X1</p>	<p>D</p>  <p>M10*70L X1</p>	<p>E</p>  <p>X1</p>	<p>F</p>  <p>X1</p>
<p>H</p>  <p>X2</p>	<p>J</p>  <p>X1</p>	<p>K</p>  <p>M6*16L X4</p>	<p>L</p>  <p>X4</p>	<p>M</p>  <p>M10 X2</p>	<p>N</p>  <p>X1</p>
<p>P</p>  <p>X4</p>	<p>Q</p>  <p>X1</p>	<p>R</p>  <p>M6 X20</p>	<p>S</p>  <p>M10 X2</p>	<p>T</p>  <p>M6 X1</p>	<p>U</p>  <p>M10 X2</p>
<p>V</p>  <p>M6 X1</p>	<p>Y</p>  <p>58*27mm X2</p>				

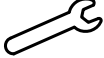
1

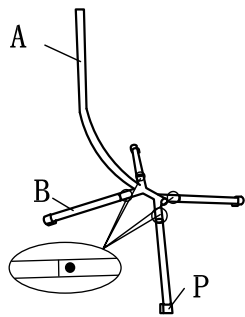

2

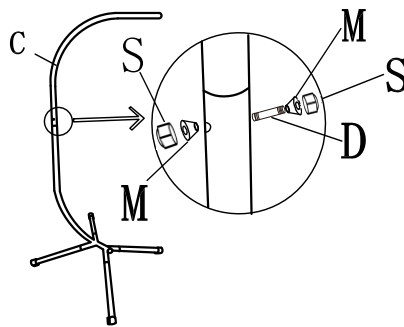

3

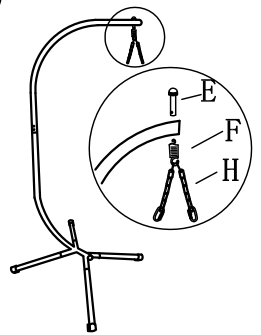

4

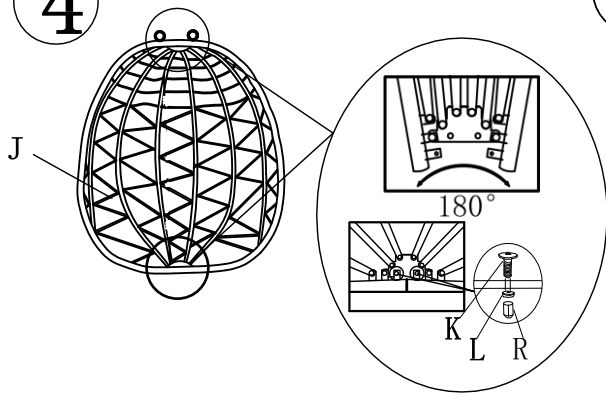

5

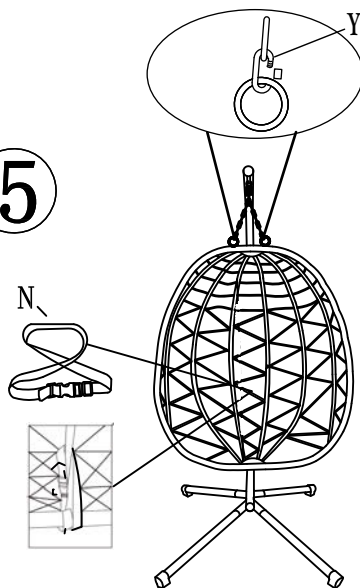

6

