

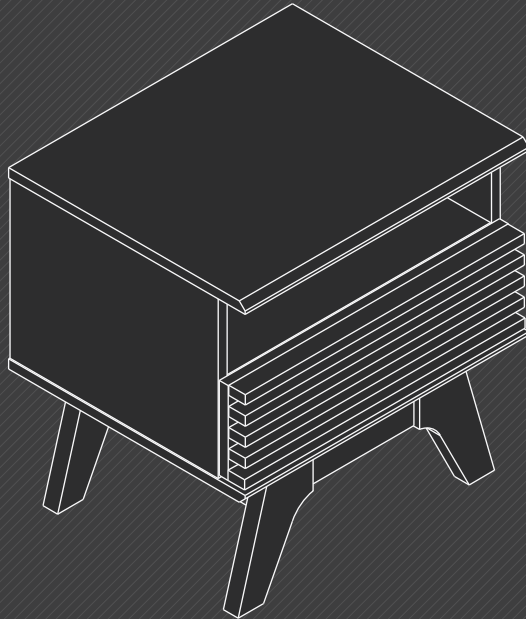

MID-CENTURY MODERN STYLE 1-DRAWER NIGHTSTAND



USER MANUAL



Contents

TOPIC

PAGE

01	SAFETY INSTRUCTIONS	01-01
	1-1 Thank You For Choosing Our Product	01
	1-2 Precautions	01

02	INSTALLING MODULES	02-15
	2-1 Disassembly Diagram	02
	2-2 Parts List	03-06
	2-3 Assembly Instructions	07-15

03	CUSTOMER SERVICE	16
	3-1 30-Day Return Policy	16
	3-2 1-Year Warranty	16
	3-3 Quick Response Within 24 Hours	16

04	PROBLEMS YOU MAY ENCOUNTER	17
	4-1 Problems You May Encounter	17

Safety Instructions

Thank You For Choosing Our Product

Before assembly, please read this USER MANUAL first, and check according to Parts List to make sure all parts are included. Feel free to contact us if you have any concerns or questions about your product, we are always ready to help. Your satisfaction is our first priority!

Precautions

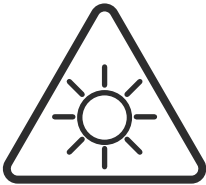

- Avoid long-term direct sunlight exposure.



- Keep away from sharp objects.

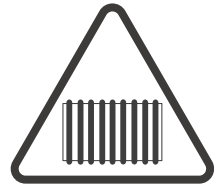

- Keep away from heat.

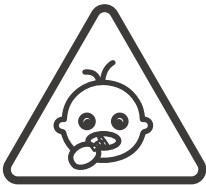

- Keep infants/children away from assembly parts to avoid choking and suffocation.



- Keep away from corrosive substances.

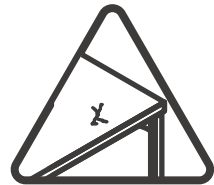

- Pay attention to avoid over-tightening fasteners, or they may induce cracking within the board.



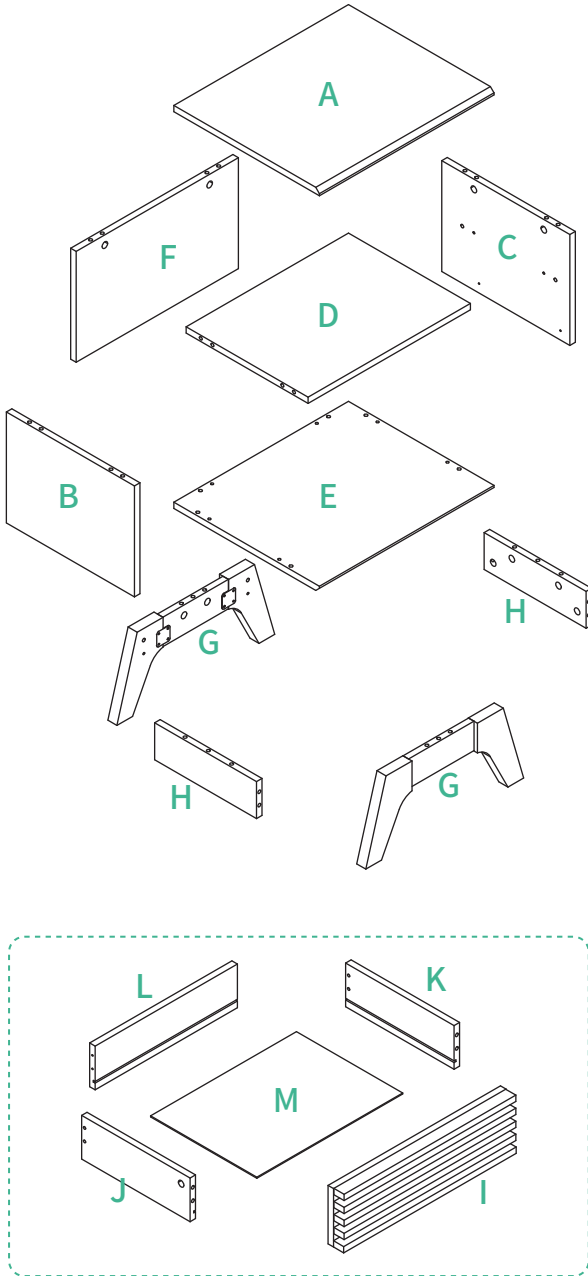



Disassembly Diagram

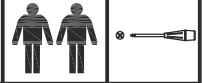

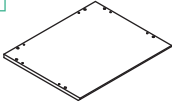
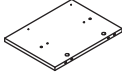
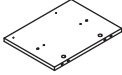
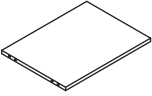
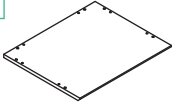
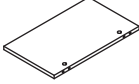
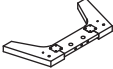

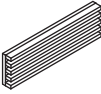



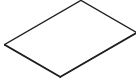
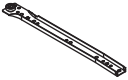
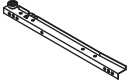
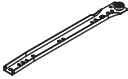
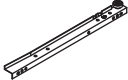



Parts List

For ease and safety, we recommend two people for assembly.



1PC	A x1 	B x1 	C x1 
D x1 	E x1 	F x1 	G x2 
H x2 	I x1 	J x1 	K x1 
L x1 	M x1 		
CL x1 	CR x1 	DL x1 	DR x1 

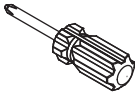



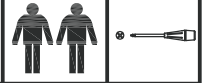

Parts List

<p>① x27</p>  <p>3 Spares</p>	<p>② x29</p>  <p>M8x30</p> <p>3 Spares</p>	<p>③ x7</p>  <p>M6x50</p> <p>1 Spare</p>	<p>④ x14</p>  <p>M3x12</p> <p>2 Spares</p>
<p>⑤ x5</p>  <p>M4x38</p> <p>1 Spare</p>	<p>⑥ x27</p>  <p>3 Spares</p>	<p>⑦ x27</p>  <p>3 Spares</p>	<p>⑧ x2</p>  <p>1 Spare</p>
<p>⑨ x1</p> 	<p>⑩ x5</p>  <p>1 Spare</p>		

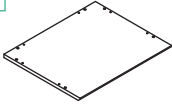
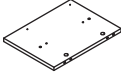
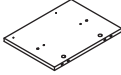
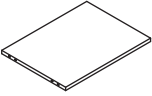
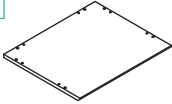
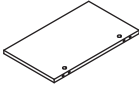
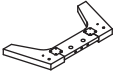

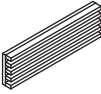



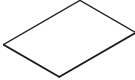
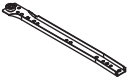
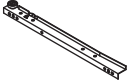
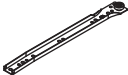
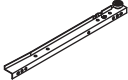

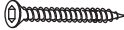

Parts List

For ease and safety, we recommend two people for assembly.

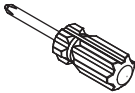

2PC	A x2 	B x2 	C x2 
	D x2 	E x2 	F x2 
	G x4 	H x4 	I x2 
	J x2 	K x2 	L x2 
M x2 	CL x2 	CR x2 	DL x2 
			DR x2 

Parts List

<p>①</p> <p>x51</p>  <p>3 Spares</p>	<p>②</p> <p>x55</p>  <p>3 Spares</p>	<p>③</p> <p>x14</p>  <p>2 Spares</p>	<p>④</p> <p>x27</p>  <p>3 Spares</p>
<p>⑤</p> <p>x9</p>  <p>M4x38</p> <p>1 Spare</p>	<p>⑥</p> <p>x51</p>  <p>3 Spares</p>	<p>⑦</p> <p>x51</p>  <p>3 Spares</p>	<p>⑧</p> <p>x2</p>  <p>1 Spare</p>
<p>⑨</p> <p>x1</p> 	<p>⑩</p> <p>x9</p>  <p>1 Spare</p>		

If you purchased a 2-pack, please refer to the following steps and repeat the operation.

Assembly Instructions

When installing, please lay soft pad on the ground to avoid scratch product.

1

Before assembling the product, please pre-assemble accessories ①. Please install each accessory correctly as shown in the diagram.

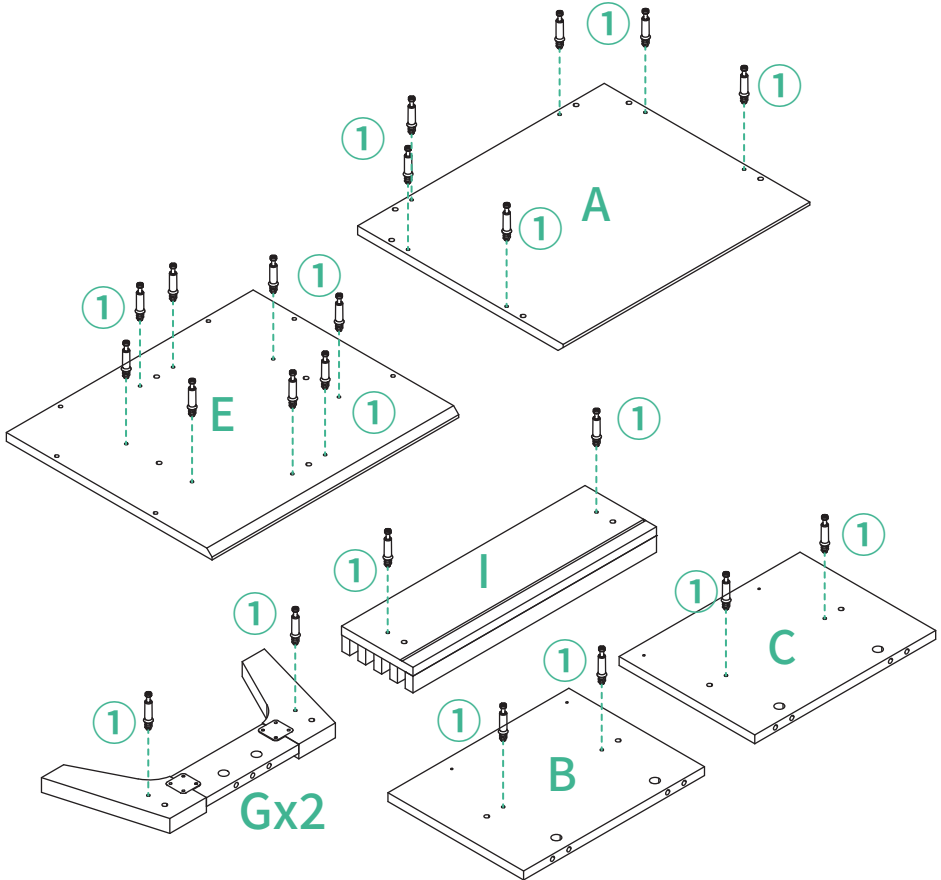

① x24		⑨ x1	
----------	--	---------	--

A x1		B x1		C x1		E x1		G x2		I x1	
---------	--	---------	--	---------	--	---------	--	---------	--	---------	--

Assembly Instructions

2

Before assembling the product, please pre-assemble accessories ②. Please install each accessory correctly as shown in the diagram.

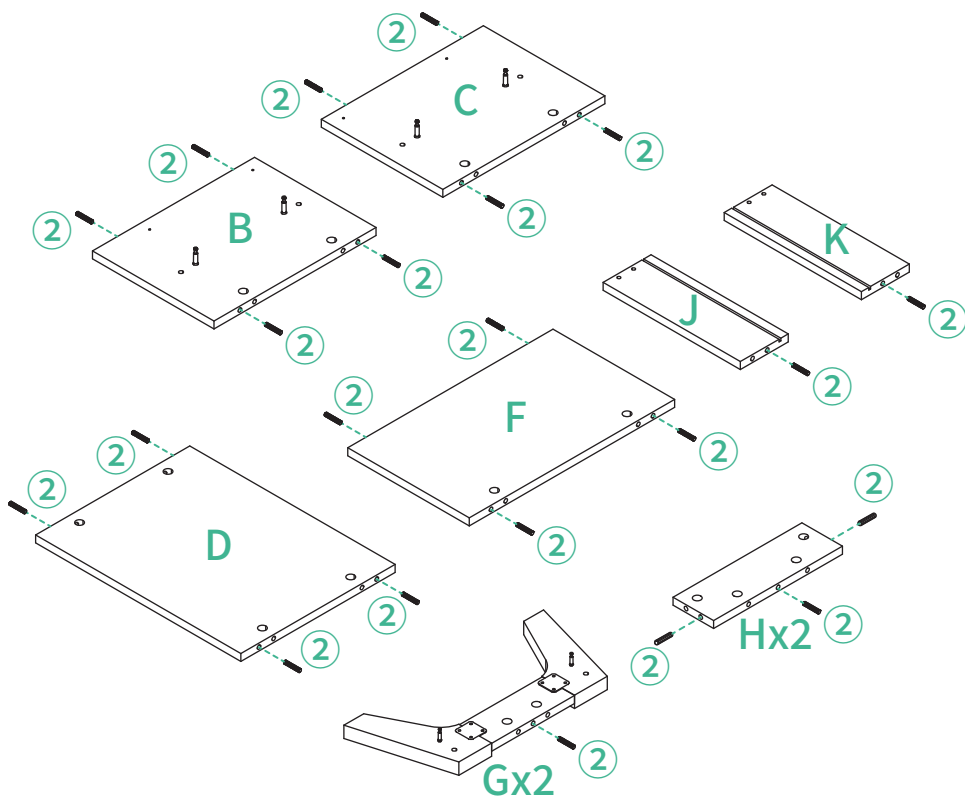

J x1		K x1		② x26	
----------------	--	----------------	--	-----------------	--

B x1		C x1		D x1		F x1		G x2		H x2	
----------------	--	----------------	--	----------------	--	----------------	--	----------------	--	----------------	--

Assembly Instructions

3

Install the drawer slides CL on board B and CR on C.
Please pay attention to choosing the correct screw holes

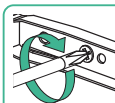

Please tighten the screws, or the guide rail will make noise.

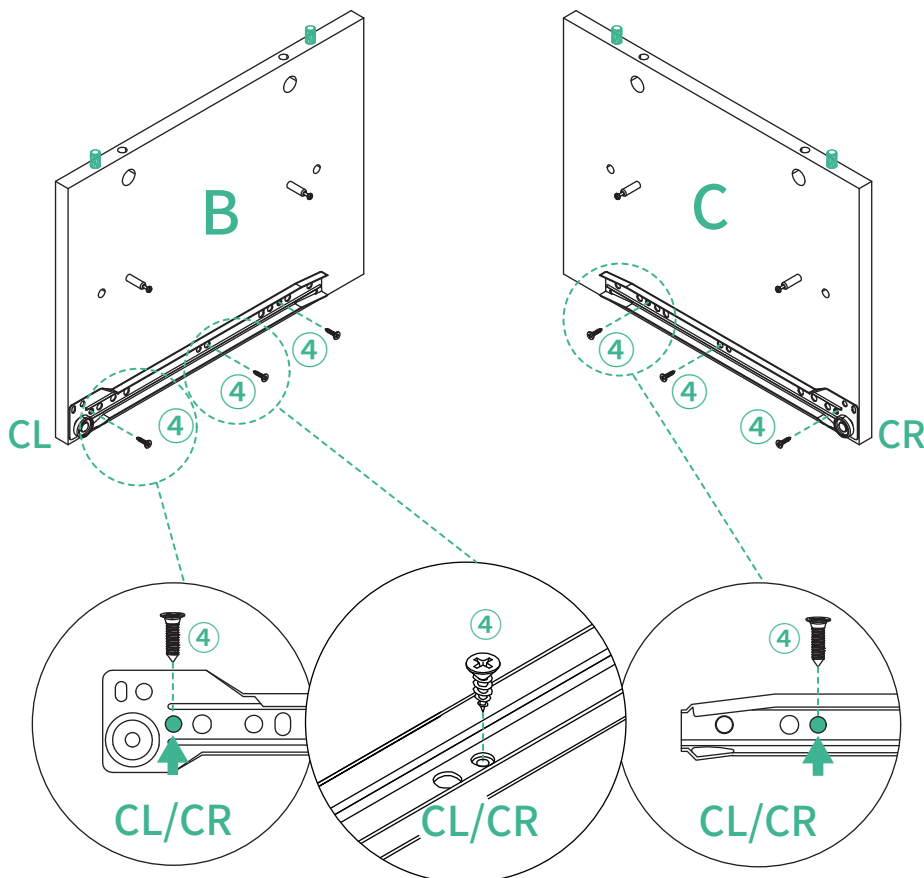

B x1		C x1		CL x1		CR x1		4 x6		9 x1	
----------------	--	----------------	--	-----------------	--	-----------------	--	----------------	--	----------------	--

Assembly Instructions

4

Install the drawer.
Please pay attention to tightening the Cam Lock.

1

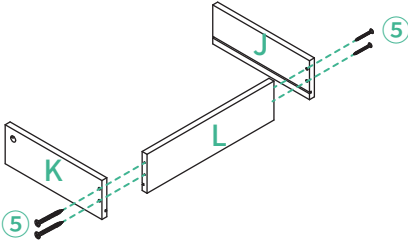

2

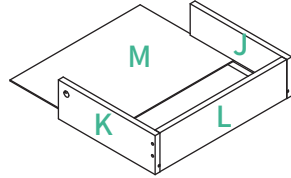

3

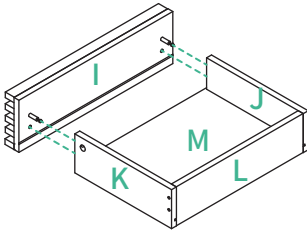

4

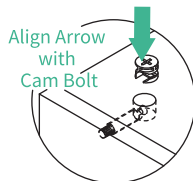
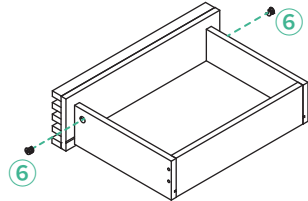

Press The Cam Lock

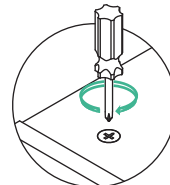

Tighten It Clockwise

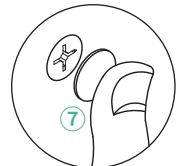

Cover The Hole

6 x2		7 x2		9 x1	
----------------	--	----------------	--	----------------	--

I x1		J x1		K x1		L x1		M x1		5 x4	
----------------	--	----------------	--	----------------	--	----------------	--	----------------	--	----------------	--

Assembly Instructions

5

Install the drawer slides DL on board J and DR on board K.
Please pay attention to choosing the correct screw holes.

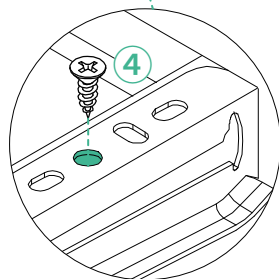
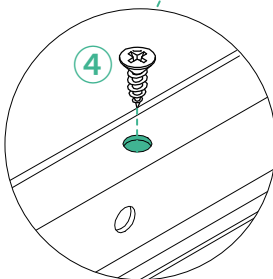
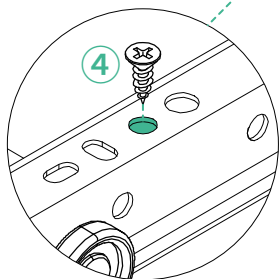
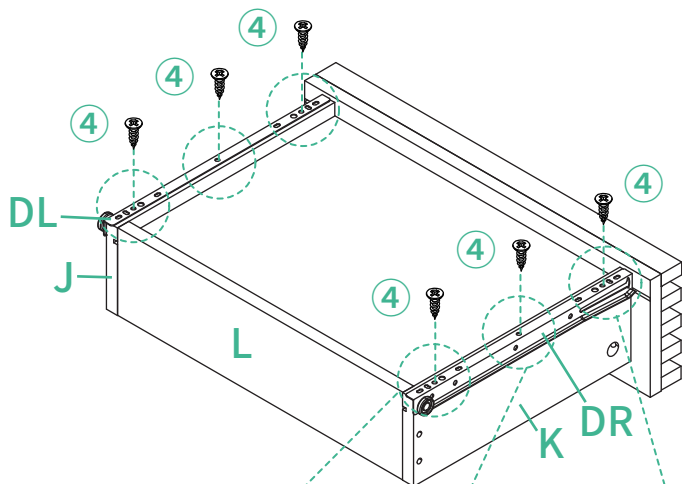

DL x1		DR x1		4 x6		9 x1	
----------	-------------------------------------------------------------------------------------	----------	-------------------------------------------------------------------------------------	---------	-------------------------------------------------------------------------------------	---------	-------------------------------------------------------------------------------------

Assembly Instructions

6

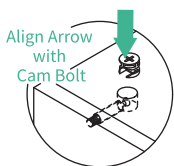
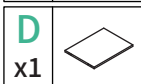
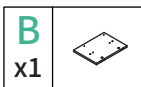

Press The
Cam Lock

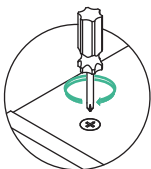

Tighten It
Clockwise



Cover
The Hole

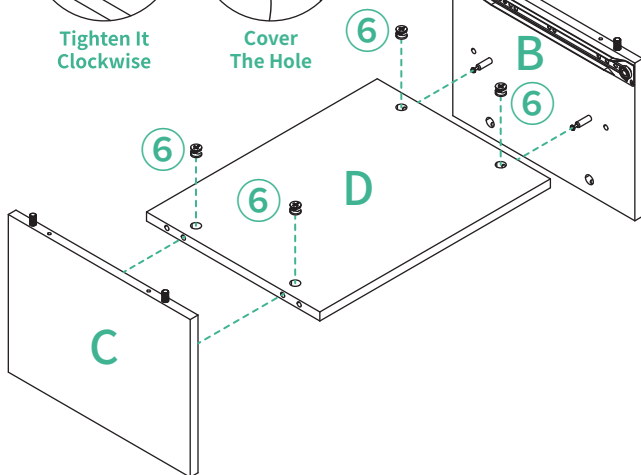

7

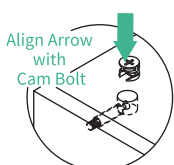
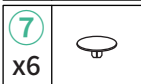
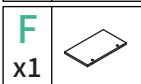

Press The
Cam Lock

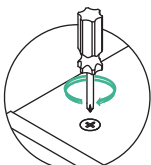

Tighten It
Clockwise



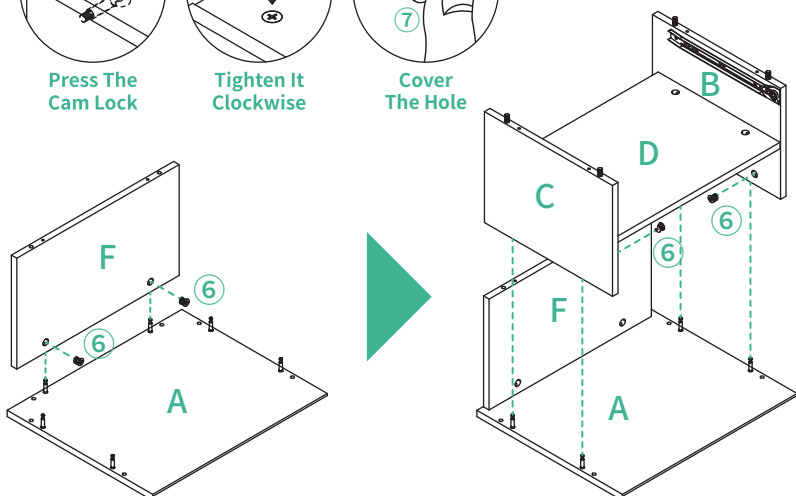

Cover
The Hole





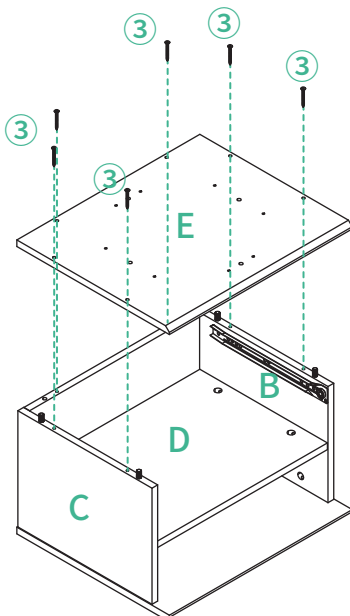

Assembly Instructions

8

E	
x1	
3	
x6	
8	
x1	



9

G	
x2	
H	
x2	
6	
x4	
7	
x4	
9	
x1	

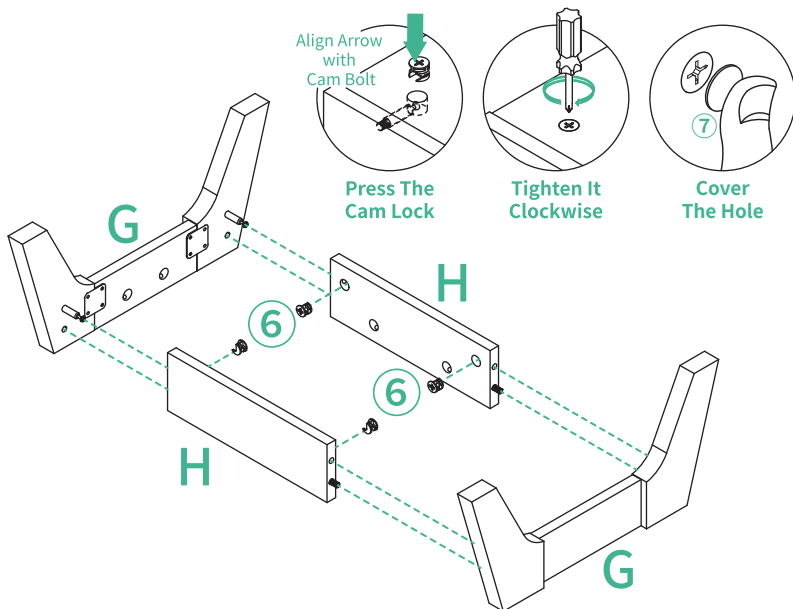

Assembly Instructions

10

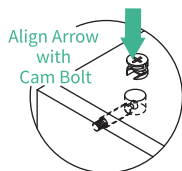

Press The Cam Lock

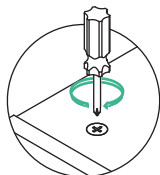

Tighten It Clockwise

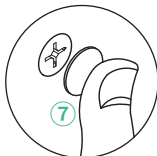

Cover The Hole

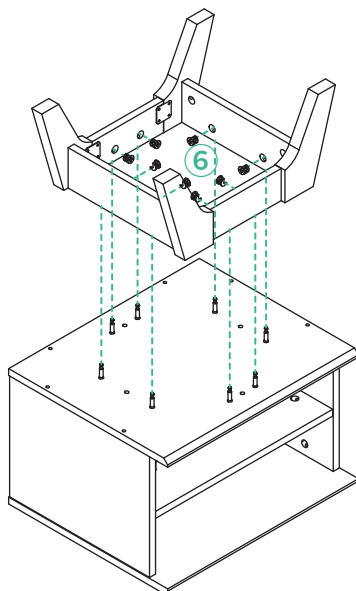

11

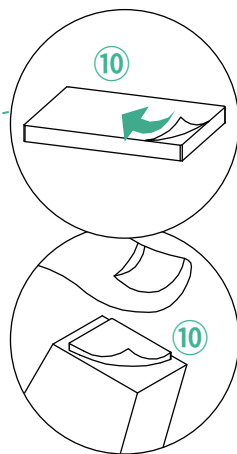
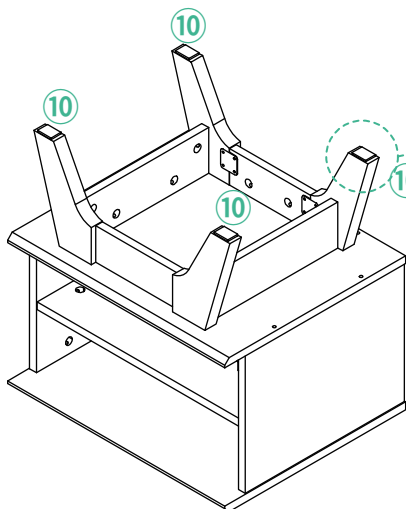
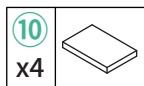

Assembly Instructions

12

Install the drawers into the cabinet as shown in the picture.

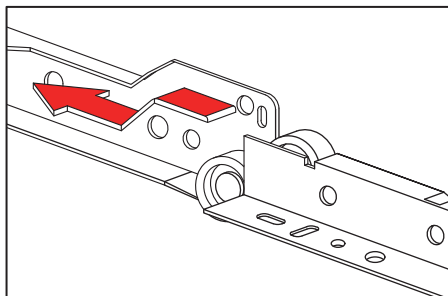
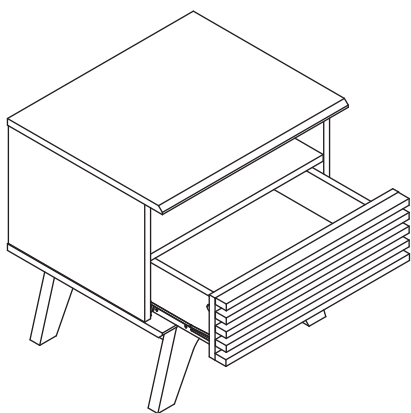
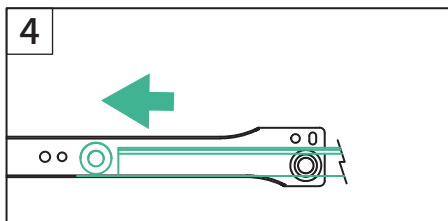
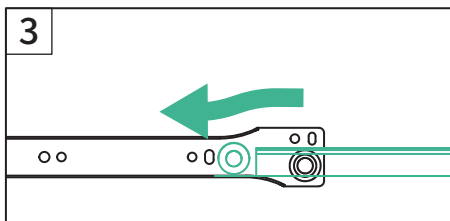
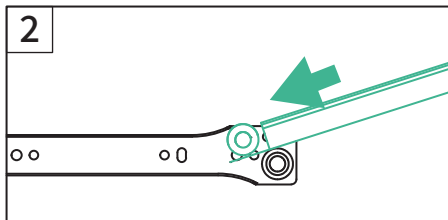
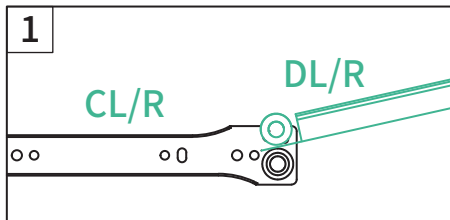



30 DAY Return Policy

If you're not completely satisfied with your purchase, please return the merchandise via our Official Customer Support. Unused merchandise can be refunded or exchanged within 30 days of purchase.



1-Year Warranty

We guarantee your product is free from defects in product material and workmanship for one (1) year starting from the date of purchase during normal use of household conditions. If your appliance fails to operate properly within our warranty period, we will arrange a new one. Replacement is free and all shipping costs are covered.



Quick Response within 24 Hours

If you are still unable to resolve the issue you are experiencing, please contact us immediately via our support email. It doesn't matter if the product has been installed or not, our customer support team will respond within 24 hours and assist you quickly and efficiently. The most efficient way to confirm your problem to us is to attach a video, which illustrates your product issues.

Problems You May Encounter

PART	PROBLEM	SOLUTION
Whole Product	Parts are missing, defective or having wrong parts in package.	Contact us via our after-sales phone or email. We will respond within 24 hours.
	Having issue(s) while reading the instruction or completing the assembly.	Contact us via our after-sales phone or email. We will respond within 24 hours.
	Encountering non - human caused damage during use.	If the product is damaged due to non - human causes, please keep the product and send us photos of it. We will ascertain the cause of the product damage within 48 hours and provide you with a satisfactory solution.
Furniture Surface	Surface is broken, scratched or lack of some screw holes.	Contact us via our after-sales phone or email. We will respond within 24 hours.
	The screw holes that on the board and the frame don't line up.	<ol style="list-style-type: none"> 1. Tighten the screws only 70% of the way. Do not fully tighten the screws until all parts are aligned. 2. Adjust the board and frame until the holes align, then fully tighten all screws.
	Surface is uneven or not tight that has gaps after being assembled.	<ol style="list-style-type: none"> 1. Loosen the screws in the uneven or gap positions; adjust until the surface is flat and tight, and then tighten the screws. 2. If your problem still can't be solved, please feel free to contact us.
Structure Frame	Components are bent, broken, chipped, rusted, or damaged.	Contact us via our after-sales phone or email. We will respond within 24 hours.
	The furniture is unstable after being assembled.	<ol style="list-style-type: none"> 1. Check if all screws are fully tightened. 2. Read through the manual and check if any parts are installed incorrectly or missing. 3. If the problem persists, please contact us.
	Encountering non - human caused damage during use.	If the product is damaged due to non - human causes, please keep the product and send us photos of it. We will ascertain the cause of the product damage within 48 hours and provide you with a satisfactory solution.

We are committed to providing our customers with premium quality products and convenient customer service.

