

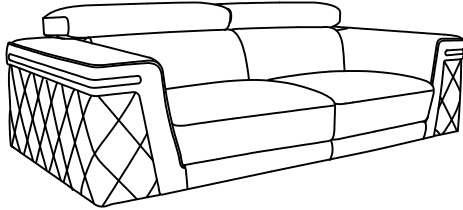
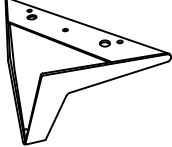
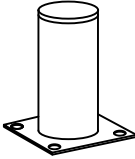

Assembly Instruction

MODEL: 1140-L

Thank you for purchasing this quality product! Make sure all components and small hardware parts are included in the package before you start to assemble the product.

Components List			Hardware List		
Serial No.	Description and Drawing	Quantity	Serial No.	Description and Drawing	Quantity
A		X1	1		4
			2		1
			3		16

Step 1

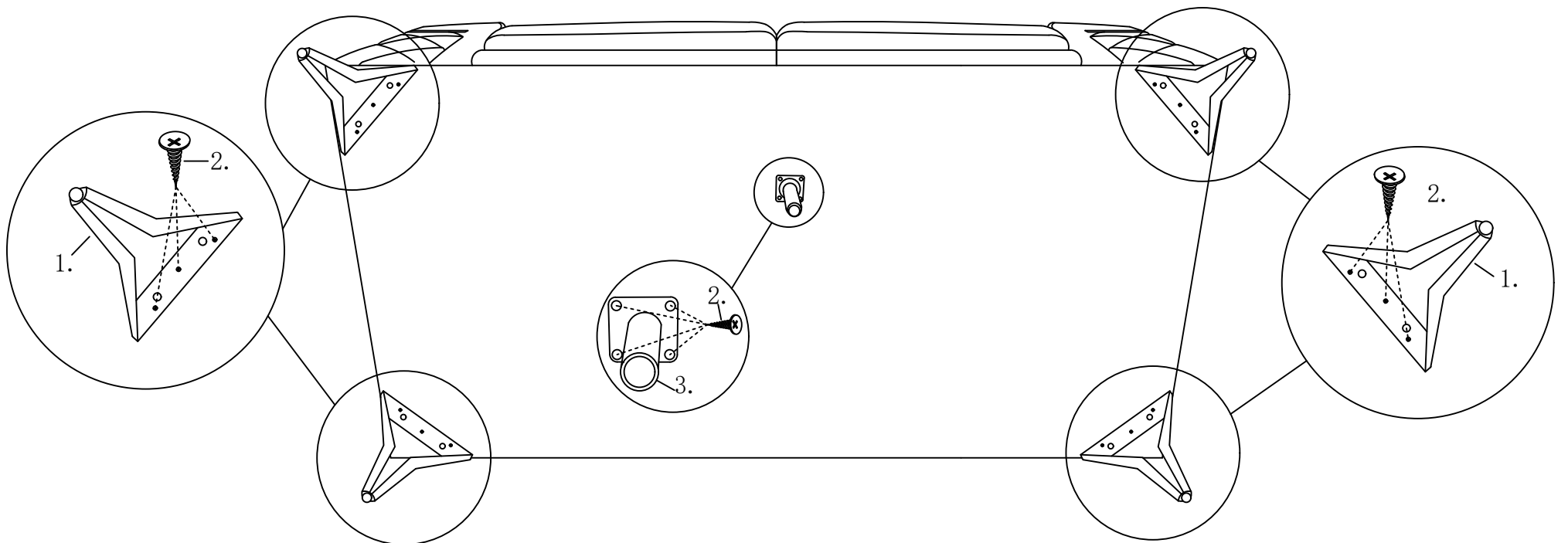

Step 2 Finished

