

# Instruction Manual

Wooden Dining Chair Set of 2, Brushed Light Acacia with Sand Rope

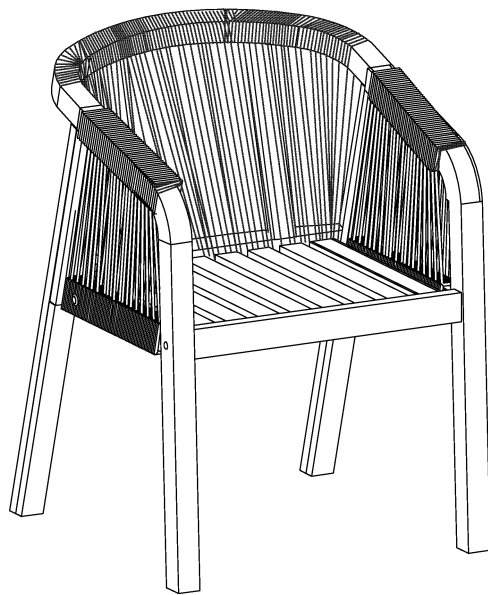

# CONTENTS

---

Safety and care advice	<b>1</b>
Components	<b>2</b>
Assembly instructions	<b>4</b>
Copyright	<b>8</b>



## ⚠ SAFETY AND CARE ADVICE ⚠

---

### PLEASE READ THESE INSTRUCTIONS CAREFULLY AND KEEP FOR FUTURE REFERENCE

- **Warning:** Please lift with care.
- Check you have all the components and tools listed on pages 2 and 3.
- Remove all fittings from the plastic bags and separate them into their groups.
- Keep children and animals away from the work area, small parts could choke if swallowed.
- Make sure you have enough space to lay out the parts before starting.
- Do not stand or put weight on the product, this could cause damage.
- Assemble the item as close to its final position (in the same room) as possible.
- Assemble on a soft level surface to avoid damaging the unit or your floor (use opened out unit carton).



- We do not recommend the use of power drill/drivers **for inserting screws**, as this could damage the unit. Only use hand screwdrivers.
- Dispose of all packaging carefully and responsibly.

## CARE AND MAINTENANCE

---

- Only clean using a damp cloth and mild detergent, do not use bleach or abrasive cleaners.
  - From time to time check that there are no loose screws on this unit.
  - This product should not be discarded with household waste. Take to your local authority waste disposal center.
- Note** *If required the next page can be cut out and used as reference throughout the assembly. Keep this page with these instructions for future reference.*

# COMPONENTS

Please check you have all the panels listed below:

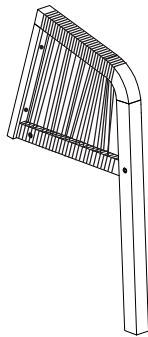
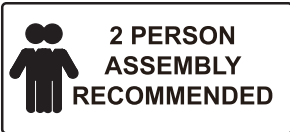

① X1

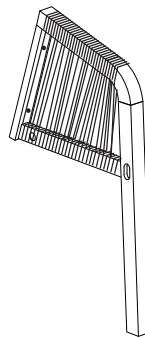

② X1

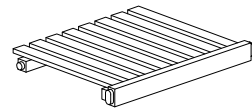

③ X1

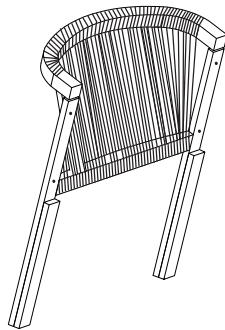

④ X1

1. Armrest 1	x 1	4. Backrest	x 1
2. Armrest 2	x 1		
3. Seat	x 1		



# COMPONENTS

---

Please check you have all the fittings listed below:



Screw (Φ6x70mm) x 2 (+1)



Screw (Φ6x50mm) x 2 (+1)



Bolt (Φ6x40mm) x 4 (+1)

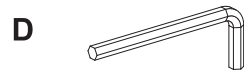

Allen key x 1





Hole Cover x 2 (+1)



# ASSEMBLY INSTRUCTIONS

---

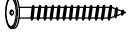
## Step 1

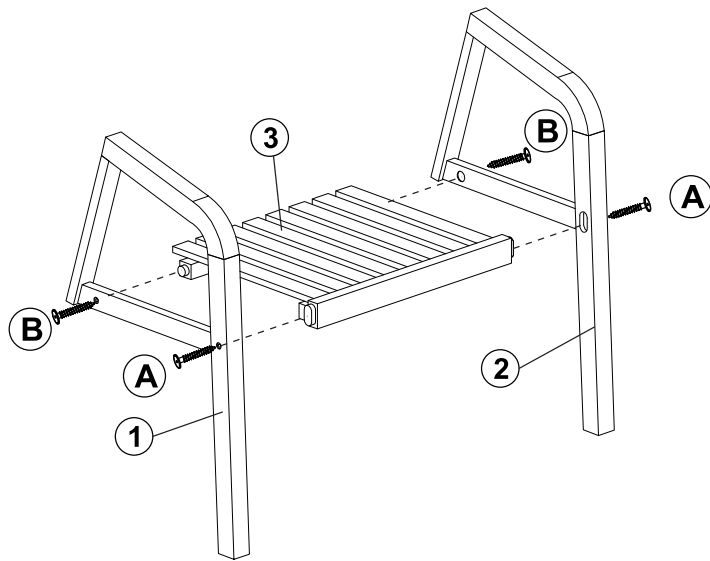

A		2	
B		2	
D		1	



# ASSEMBLY INSTRUCTIONS

---

## Step 2

C		4	
D		1	
E		2	

