

ASSEMBLY INSTRUCTION

MF298292AA

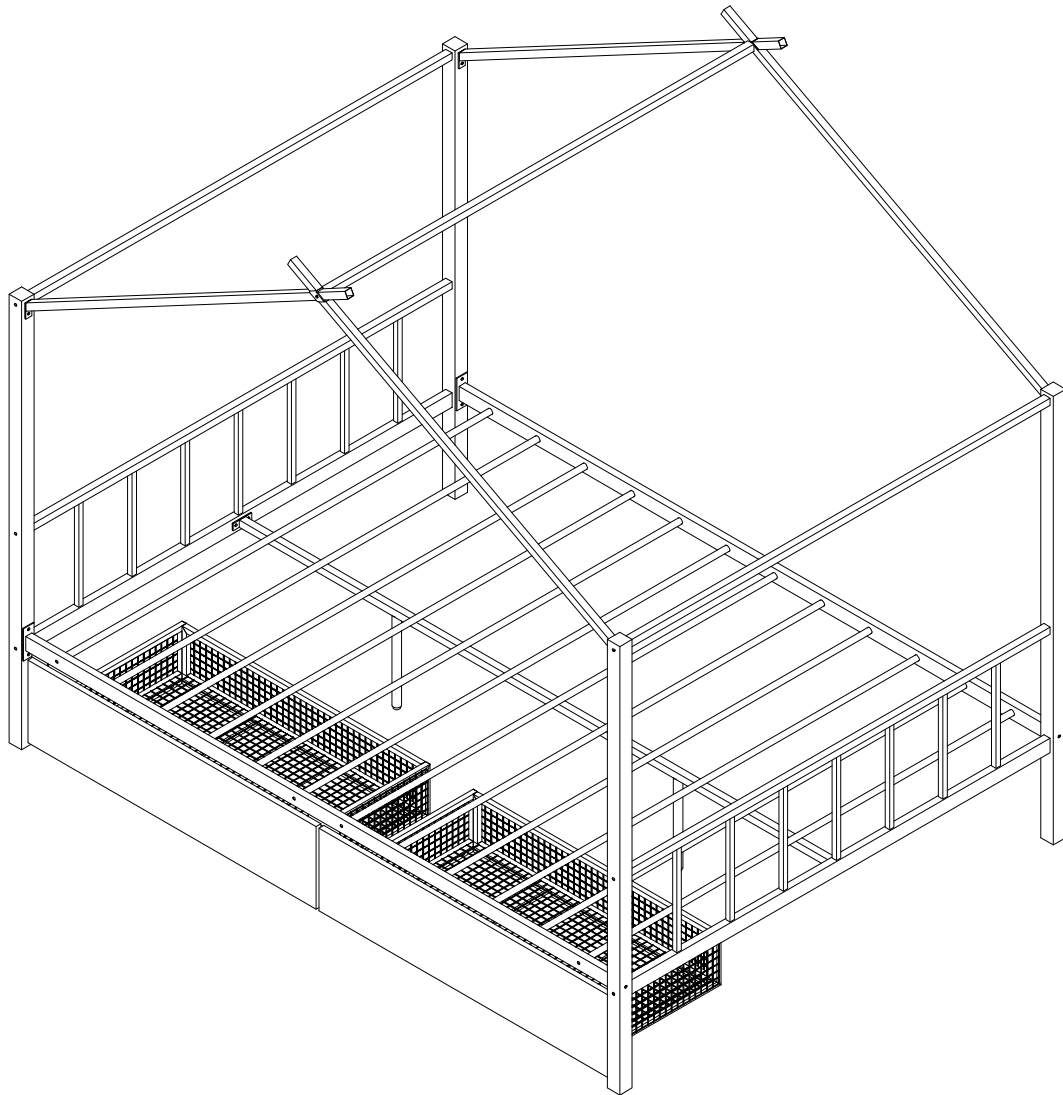

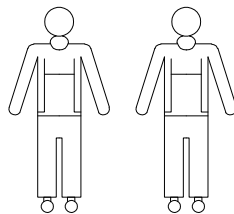



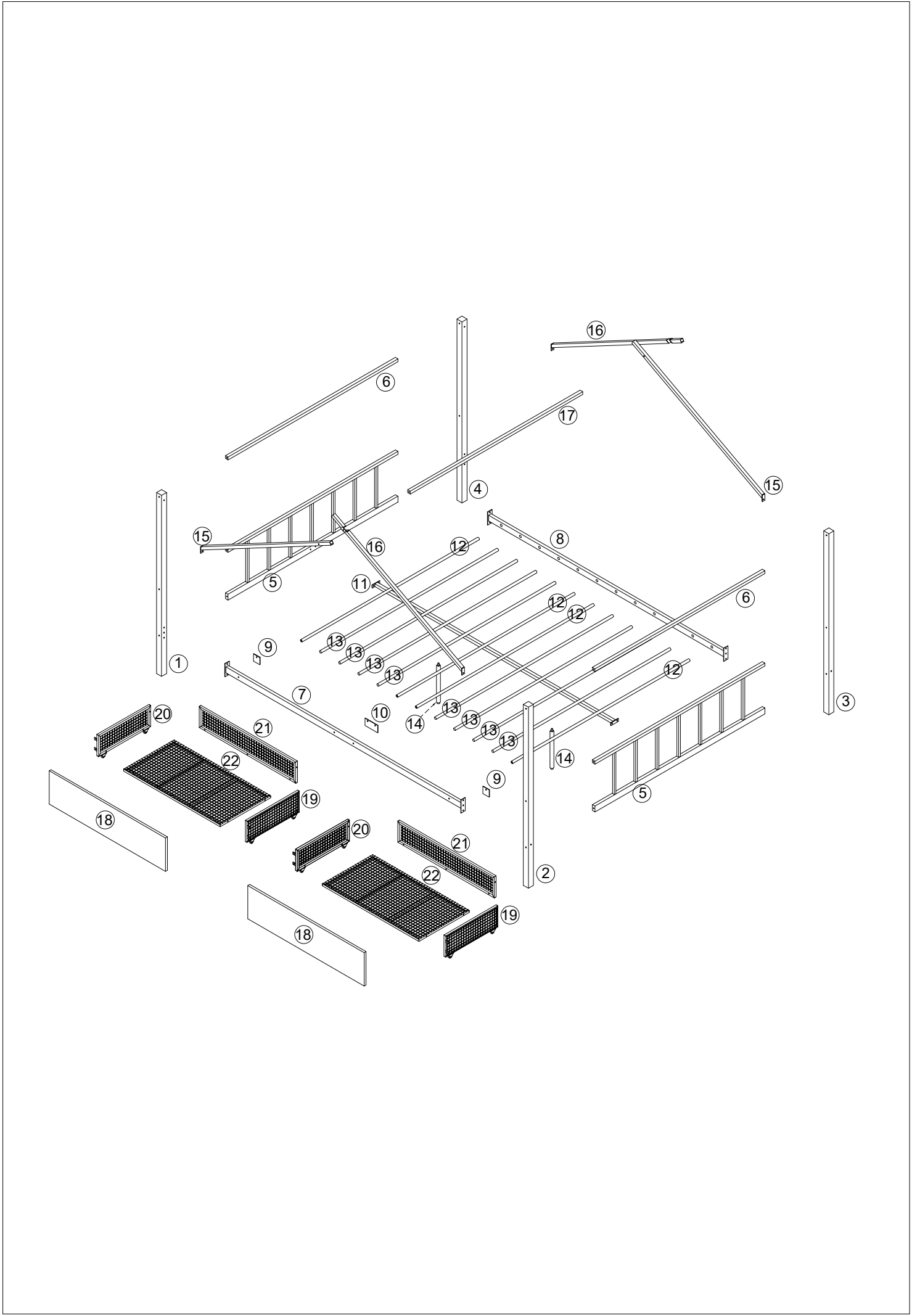





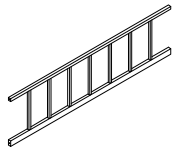
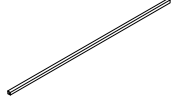
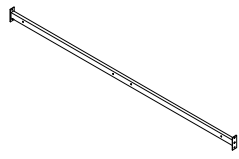
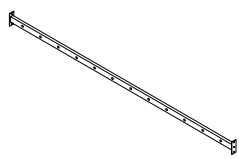

Minimum no. 2 of people
recommended to assemble
this product: Approx.
assembly time: 60 mins

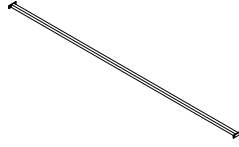
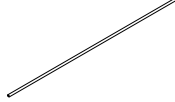
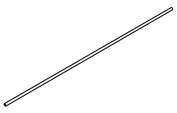



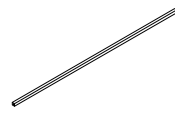
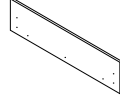

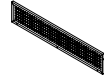
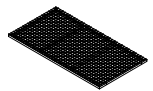







PART LIST

1		1PC	2		1PC	3		1PC
4		1PC	5		2PCS	6		2PCS
7		1PC	8		1PC	9		2PCS
10		1PC	11		1PC	12		4PCS
13		8PCS	14		2PCS	15		2PCS
16		2PCS	17		1PC	18		2PCS
19		2PCS	20		2PCS	21		2PCS
22		2PCS						

HARDWARE LIST

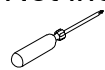
A		16PCS M $\frac{1}{4}$ "X50	B		2PCS M $\frac{1}{4}$ "X30	C		18PCS M $\frac{1}{4}$ "X20	D		28PCS M $\frac{1}{4}$ "X15
E		1PC M4X23X57	F		2PCS $\frac{1}{4}$ "x7	G		8PCS #40x40x16	H		4PCS #20x20x13
i		14PCS M4x15	j		16PCS M4x15	K		8PCS 15x20x40H	L	Not included 	1PC

STEP 1

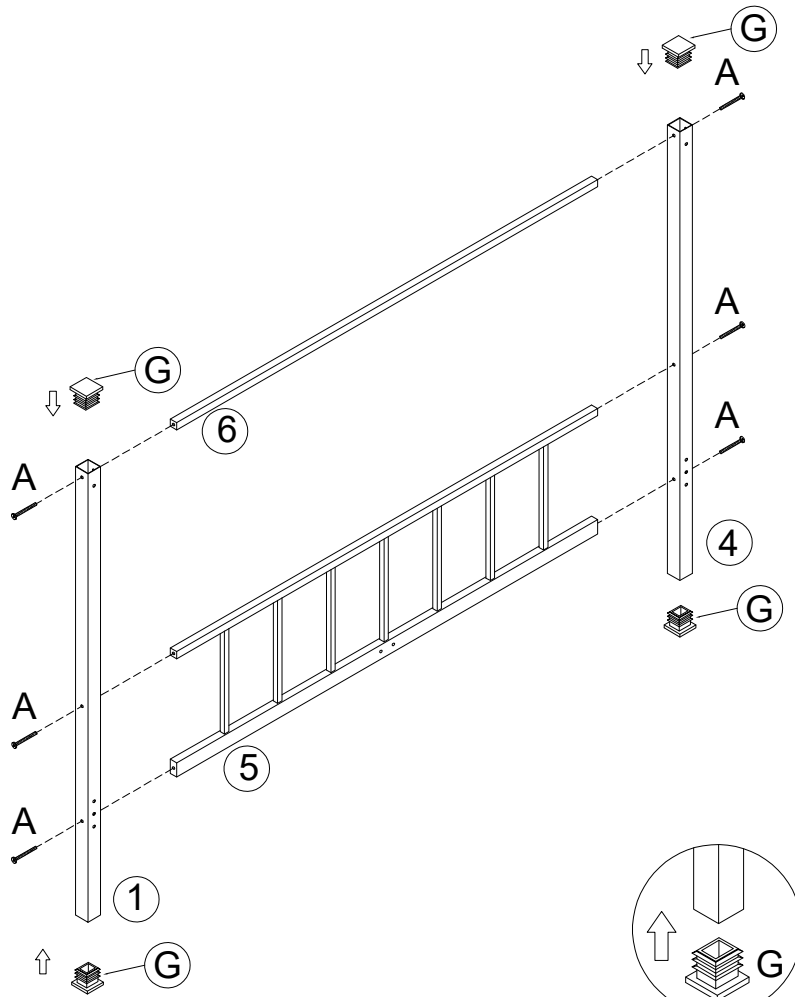

A	G
M $\frac{1}{4}$ "X50	#40x40x16
6 PCS	4 PCS

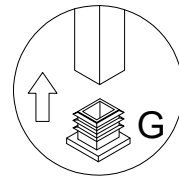
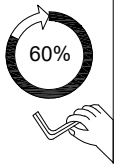

STEP 2

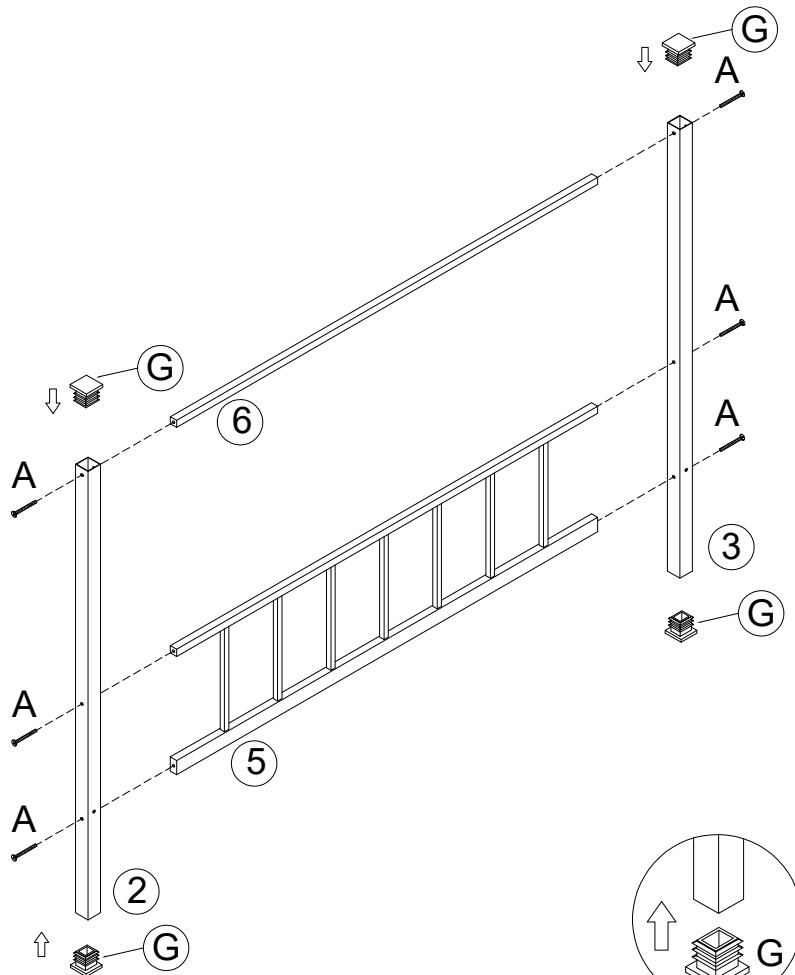

A	G
M $\frac{1}{4}$ "X50	#40x40x16
6 PCS	4 PCS

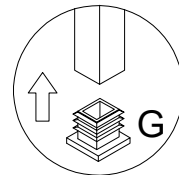
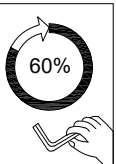

STEP 3

D
 M $\frac{1}{4}$ "X15
4 PCS

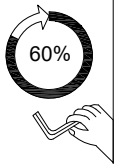
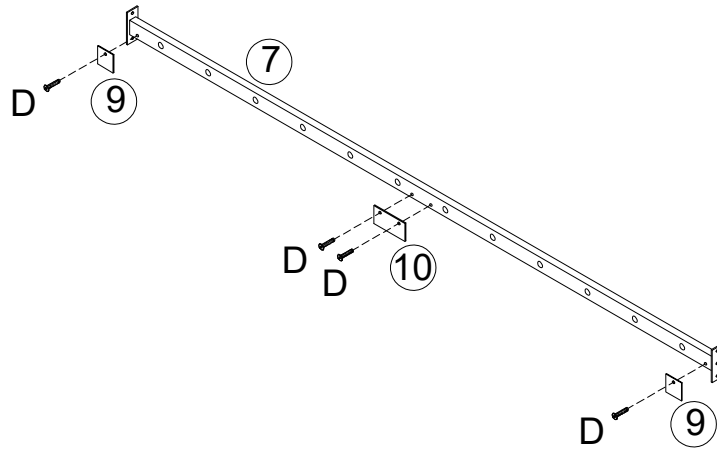

STEP 4

D
 M $\frac{1}{4}$ "X15
8 PCS

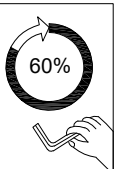
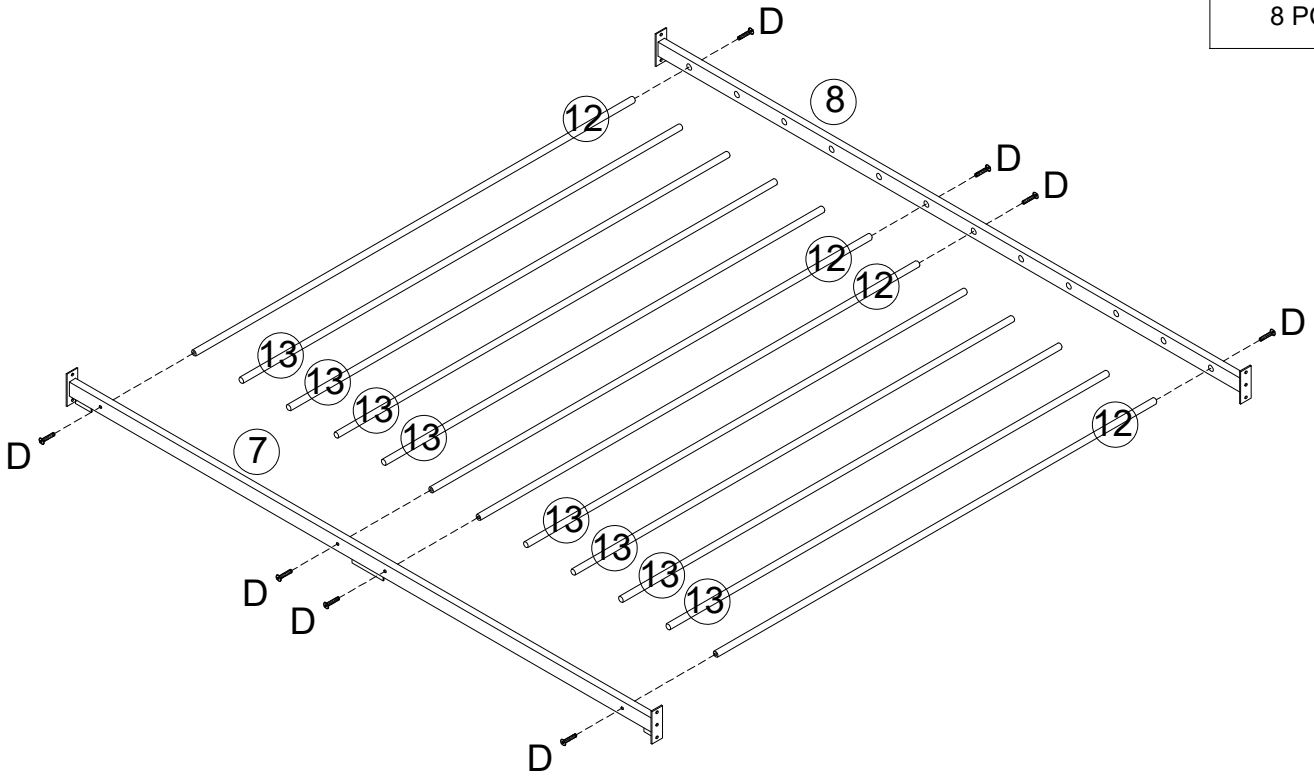

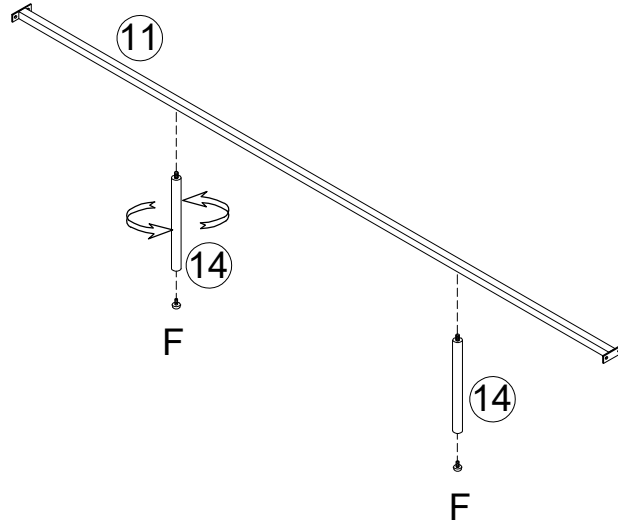

STEP 5

F
 1/4"x7
2 PCS



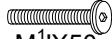

STEP 6

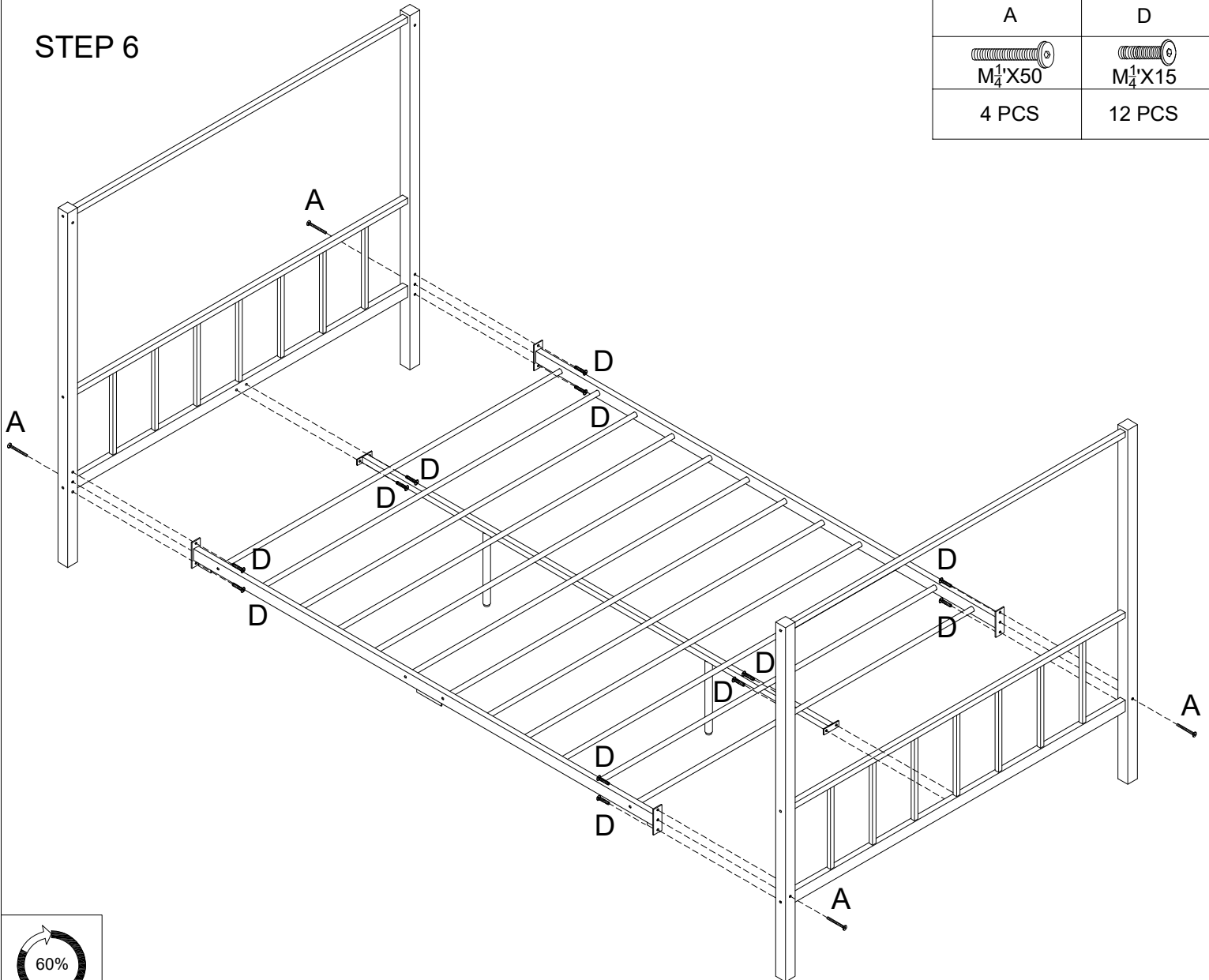
A	D
 M1/4"x50	 M1/4"x15
4 PCS	12 PCS



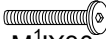

STEP 7

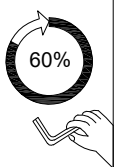
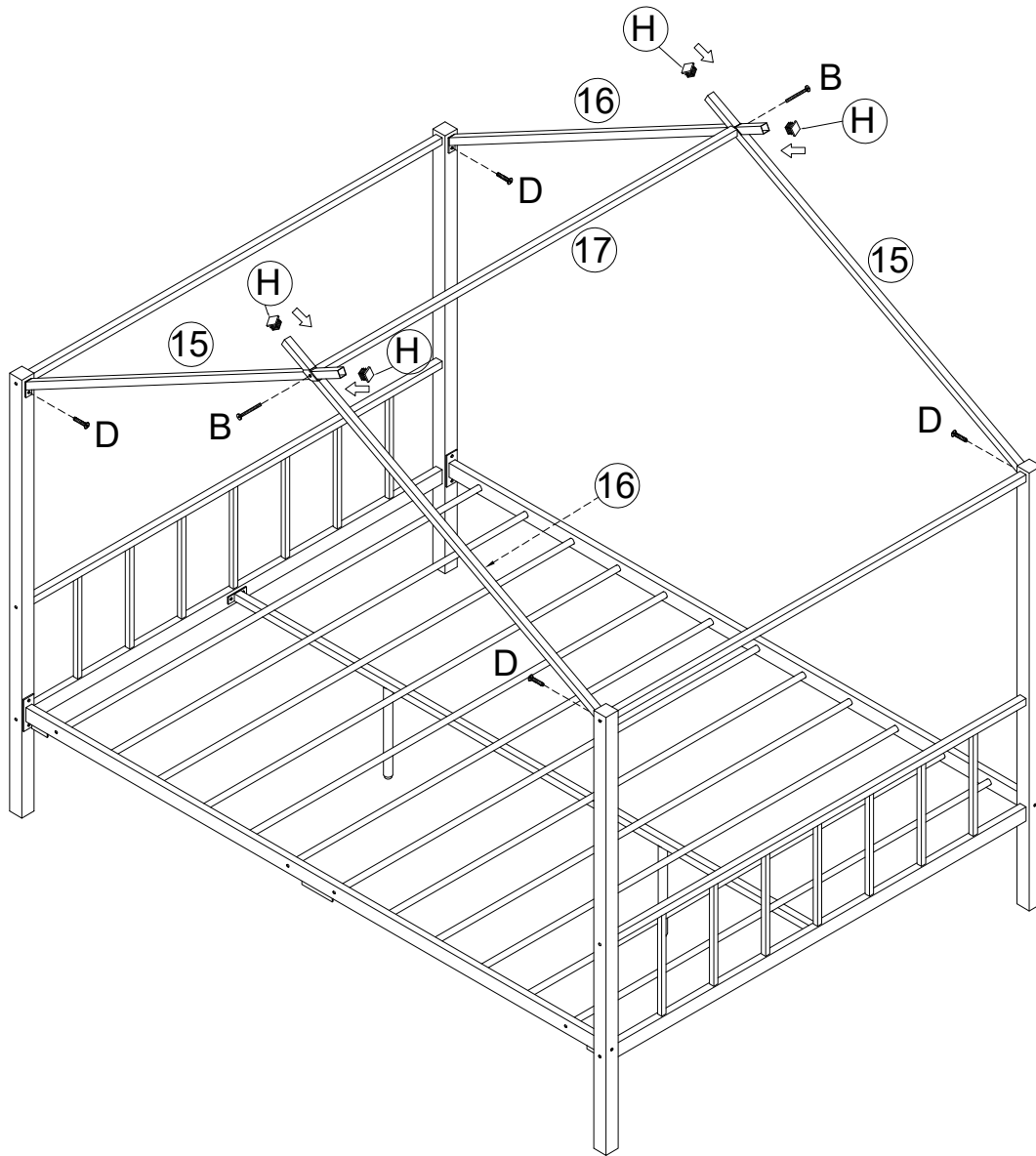
B	D	H
 M $\frac{1}{4}$ "X30	 M $\frac{1}{4}$ "X15	 #20x20x13
2 PCS	4 PCS	4 PCS

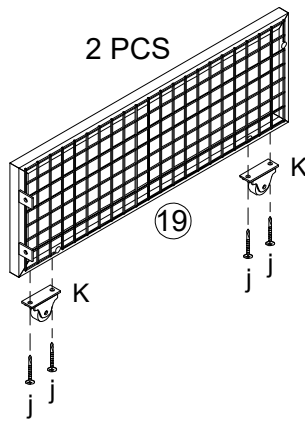
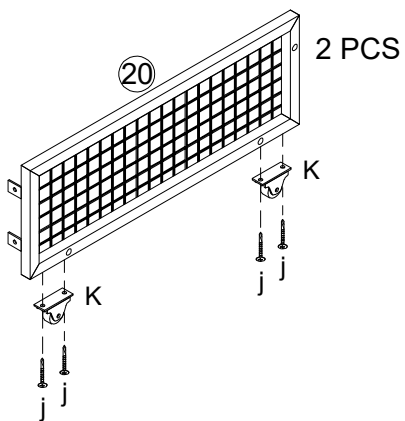

STEP 8



K	j
	
15x20x40H	M4x15
8 PCS	16 PCS



STEP 9

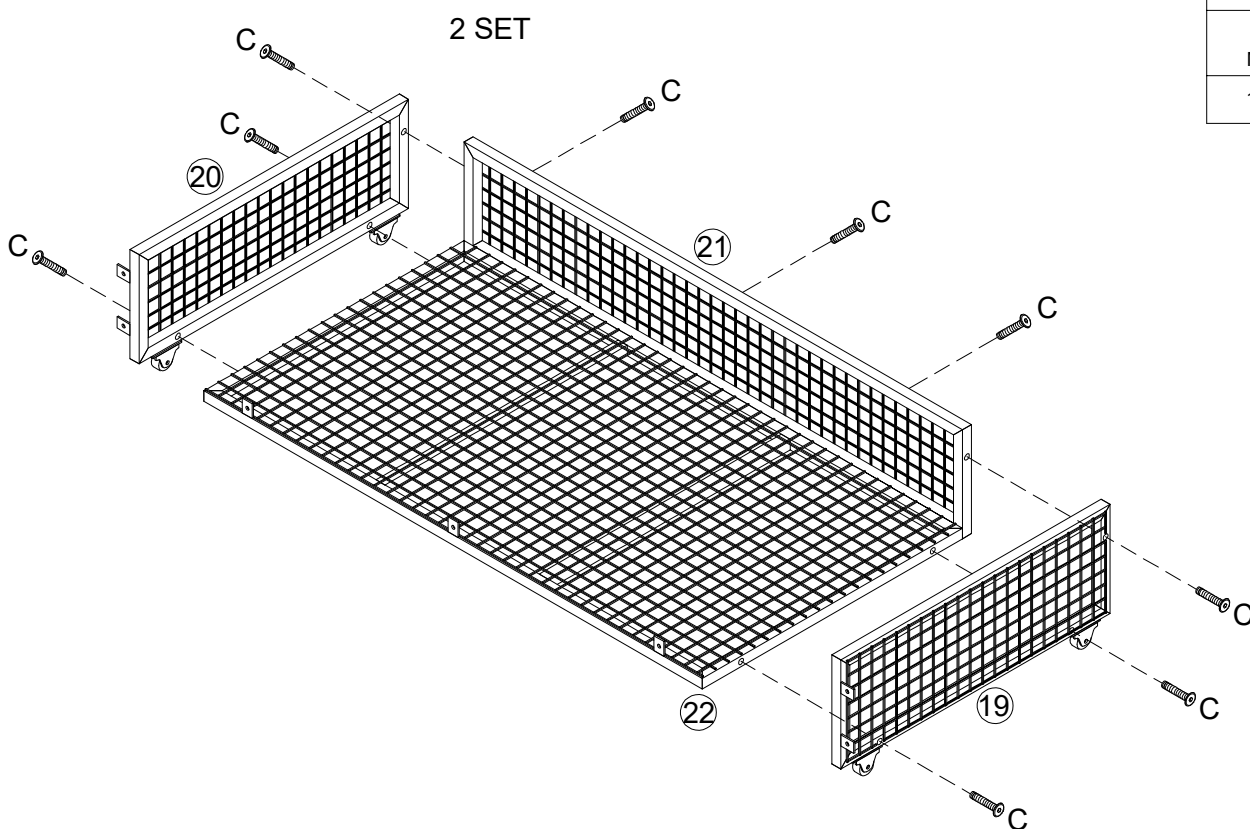

C

M4x20
18 PCS

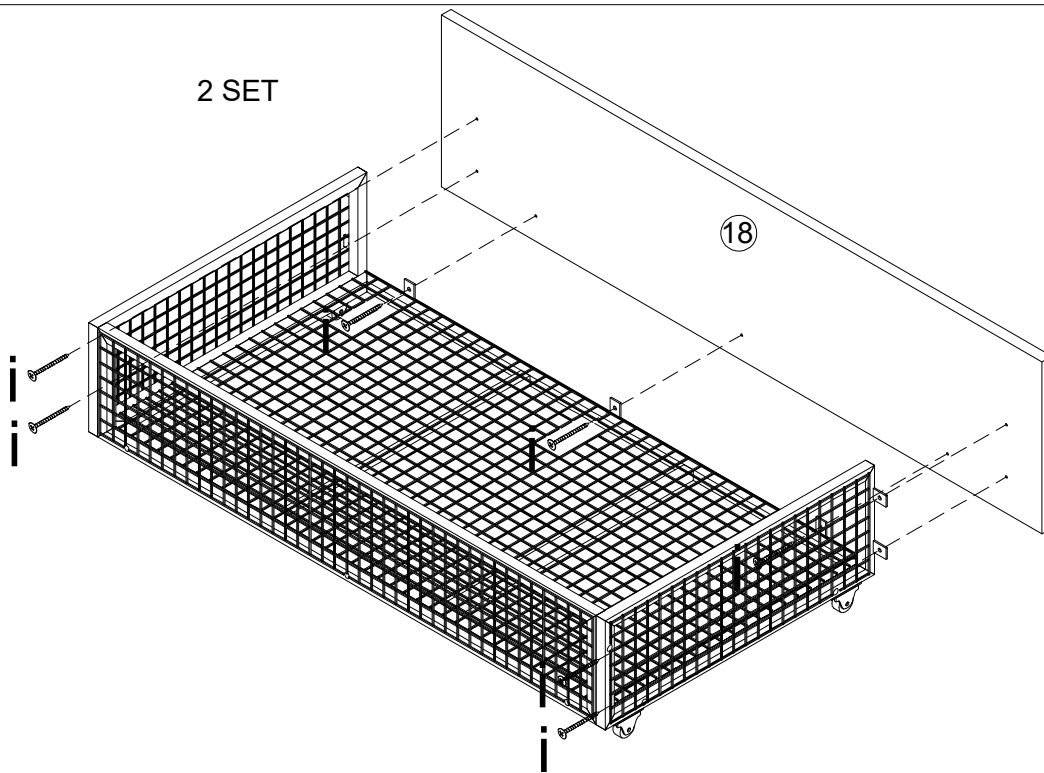

STEP 10



i

M4x15
14 PCS

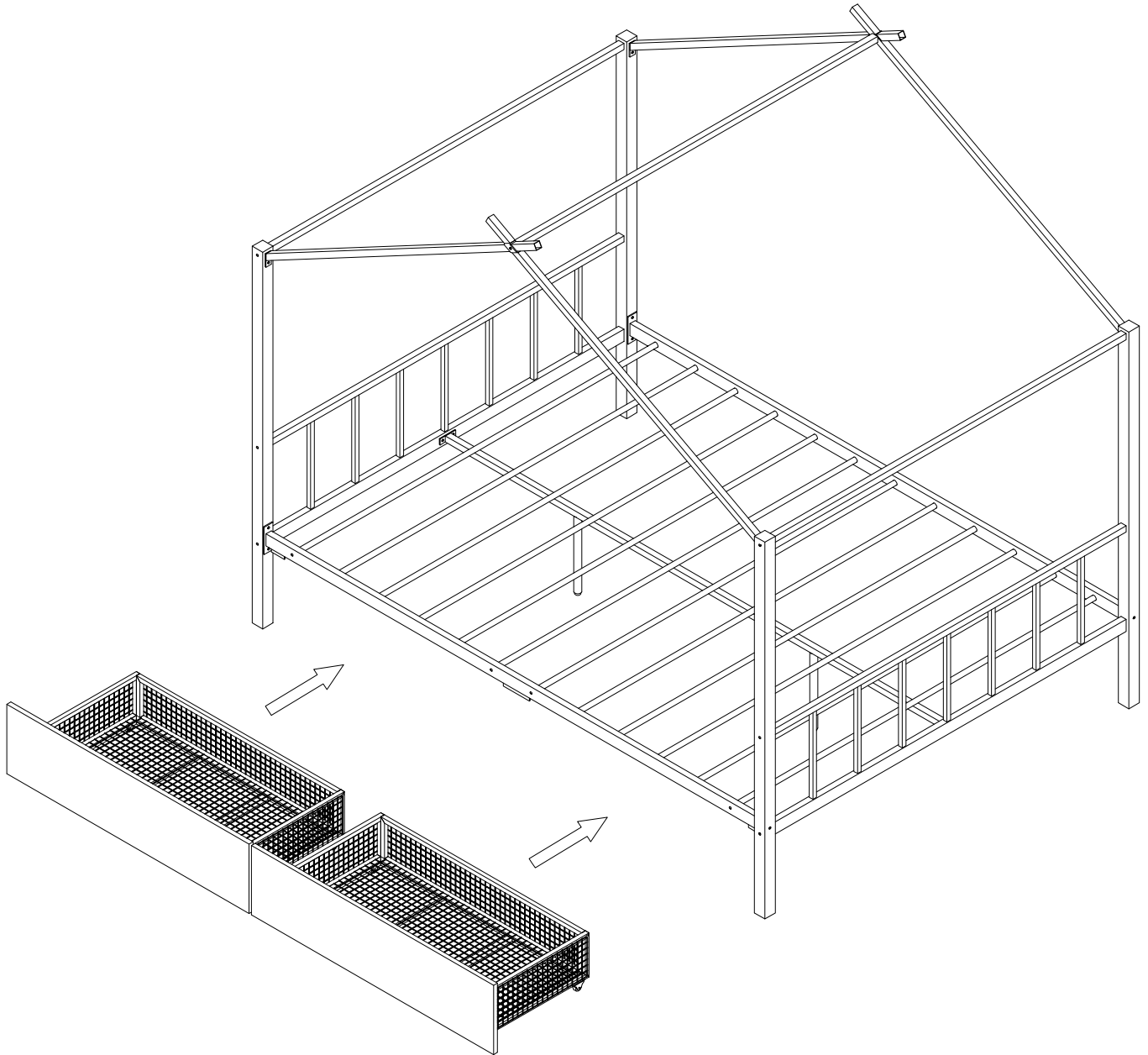

STEP 11



STEP 12

