









Assembly Instructions

Caution: You must read these Assembly Instructions before you proceed

Care & Maintenance

-  • Do not put hot items directly on furniture surface.
-  • Do not clean furniture with harsh cleansers or polish.
-  • To obtain the longest lifespan of your outdoor product minimizing exposure to direct sunlight is recommended.
-  • Children should not climb or jump on the furniture.
-  • Do not write on furniture without a padded barrier to protect the surface.
-  • To obtain the longest lifespan of your outdoor products, avoid extended and lengthy exposure to rain, snow, and direct sunshine. Whenever possible cover the product and /or place under patio or awnings.
-  • Not for commercial use. For residential use only.
-  • Stains may be removed with mild soap solution and damp cloth.
-  • Dust and pick-up spills using a clean, non-colored, lint- free cloth.

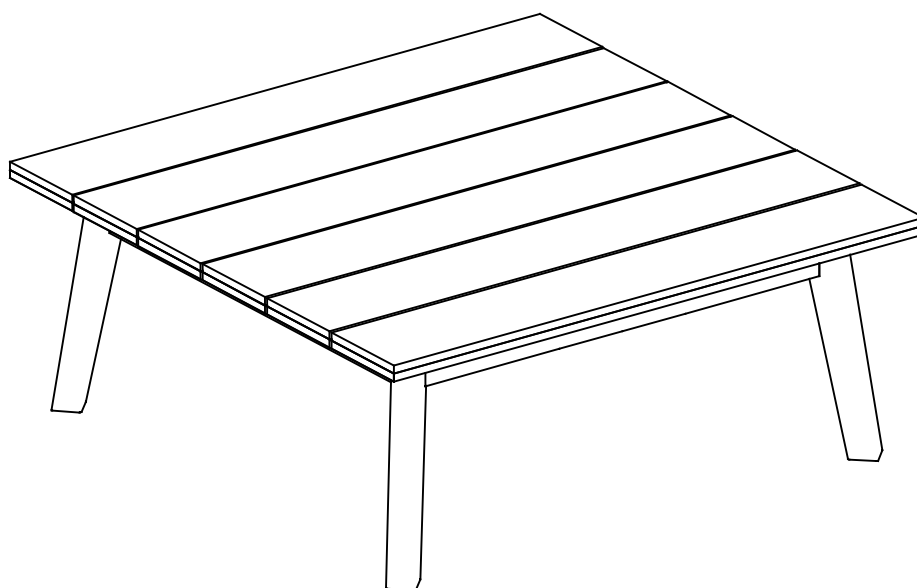

Please look into the **Table Top** for hardware packs.

Table



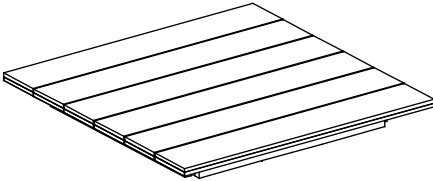

Caution: This Table is NOT a TOY.
Keep your child / children at bay in the process of assembly.
For turning the Table and to prevent damage to the Table, 01 people may be needed to execute this action.

Part List

Label	Picture	Description	Qty
A		Table top	1
B		Legs	4

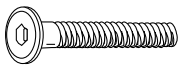
Hardware

No.	Picture	Description	Qty
①		Bolt (M6x70mm)	9
②		Washer (M6x20x2mm)	9
③		Allen Wrench	1

Assembly Preparation

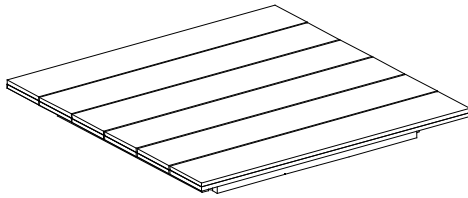

Before Beginning Assembly:



Ax1



Bx4

- | | | |
|---|-------------------------------------------------------------------------------------|----|
| ① |  | x9 |
| ② |  | x9 |
| ③ |  | x1 |



- Read instructions, cover to cover-

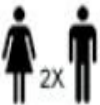

- Have 2 adults on hand for assembly-



- Do not assemble on flooring or carpet-



- Assemble on a clean non-marring surface (packing foam)-



- Save all packaging until finished-

Assembly Steps

Overview

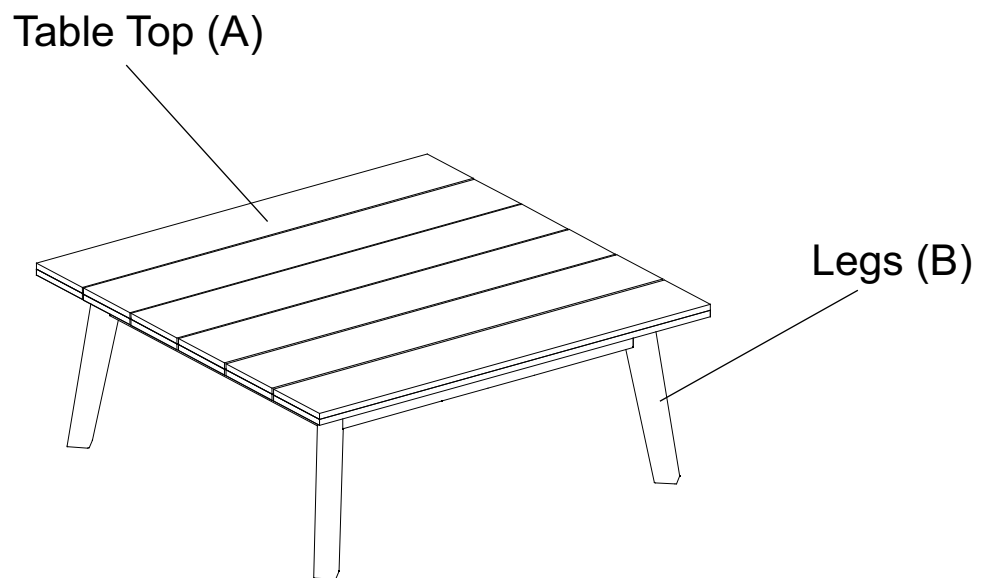

FRONT FACING

This Table has multiple parts and may require up to some 30 minutes to assemble. To give you an overview of the Table, the above picture to assemble to help you put the various parts into perspective. Please read through the instructions here below to familiarise the parts and steps before assembly.

Step 1

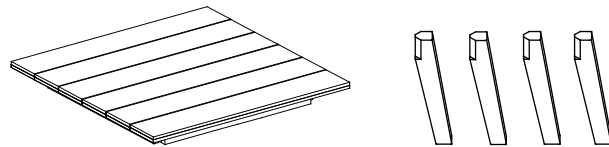

Unpack and place all parts on a clean, non-marring surface.

Step 2

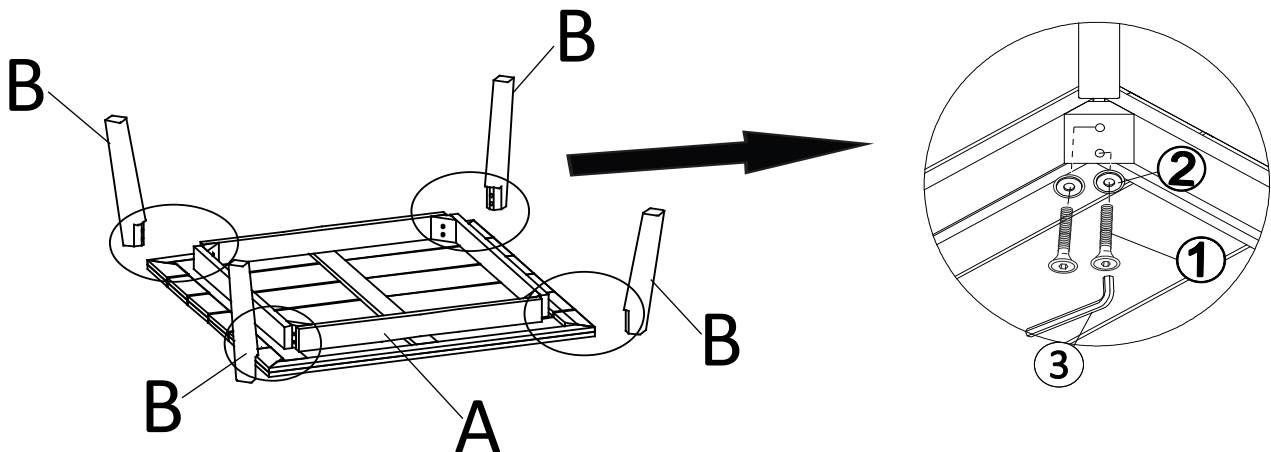

Turn the Table Top (A) (bottom-side up) and place it on a clean, soft surface to avoid any scratches or damage to the product.

Loosely affix one of the Legs (B) into one of the mounting positions at the corners of the Table Top (A), then secure it using the Bolts (①), Washers (②) and Allen Wrench (③), as shown above.

Do not fully tighten the Bolts.

Step 3

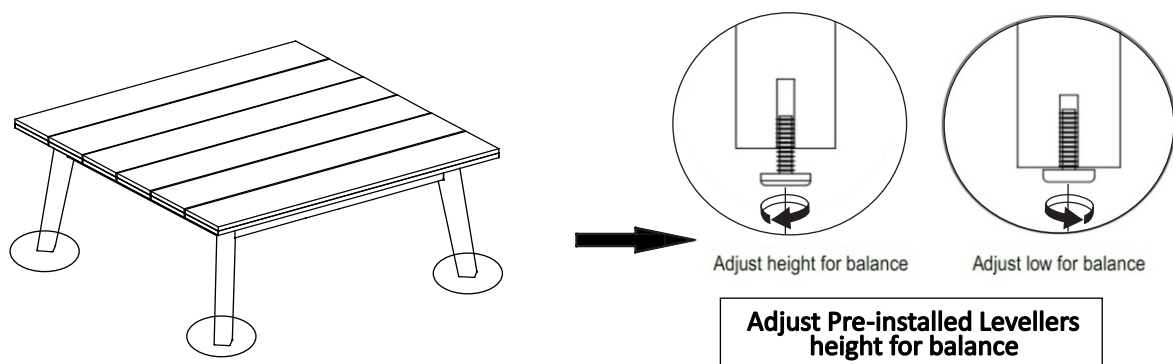

Inspect the table and make sure all parts are adequately connected.

Then EXERT pressure, floorwards onto the table with both hand

This pressure will help align all parts at all joints.

In a sequential manner, tighten all Bolts and Screws at all joints.

Adjust the Levellers until the table is level with the ground.

To adjust the Levellers, get assistance from an adult partner to lift/lean and hold the table while you are working.

CAUTION: When tightening these Bolts, tighten sequentially.

DO NOT tighten any bolt fully and then move towards the next one.

This would cause the frame to warp.

WARNING!! IF THE TABLE IS NOT STABLE , IT COULD LEAD TO DAMAGING THE PRODUCT.