

① Mirror Frame

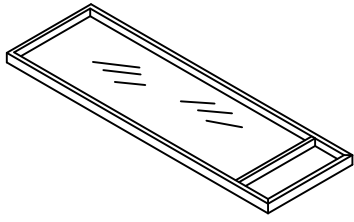

1 x

Ⓐ Long Screw

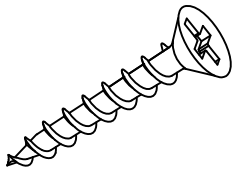

6 x

Ⓑ Wall Anchor

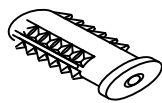

6 x

Ⓒ Bracket

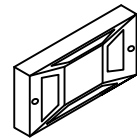

4 x

Ⓓ Short Screw

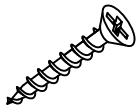

4 x

Ⓔ Plastic Strap



2 x

1

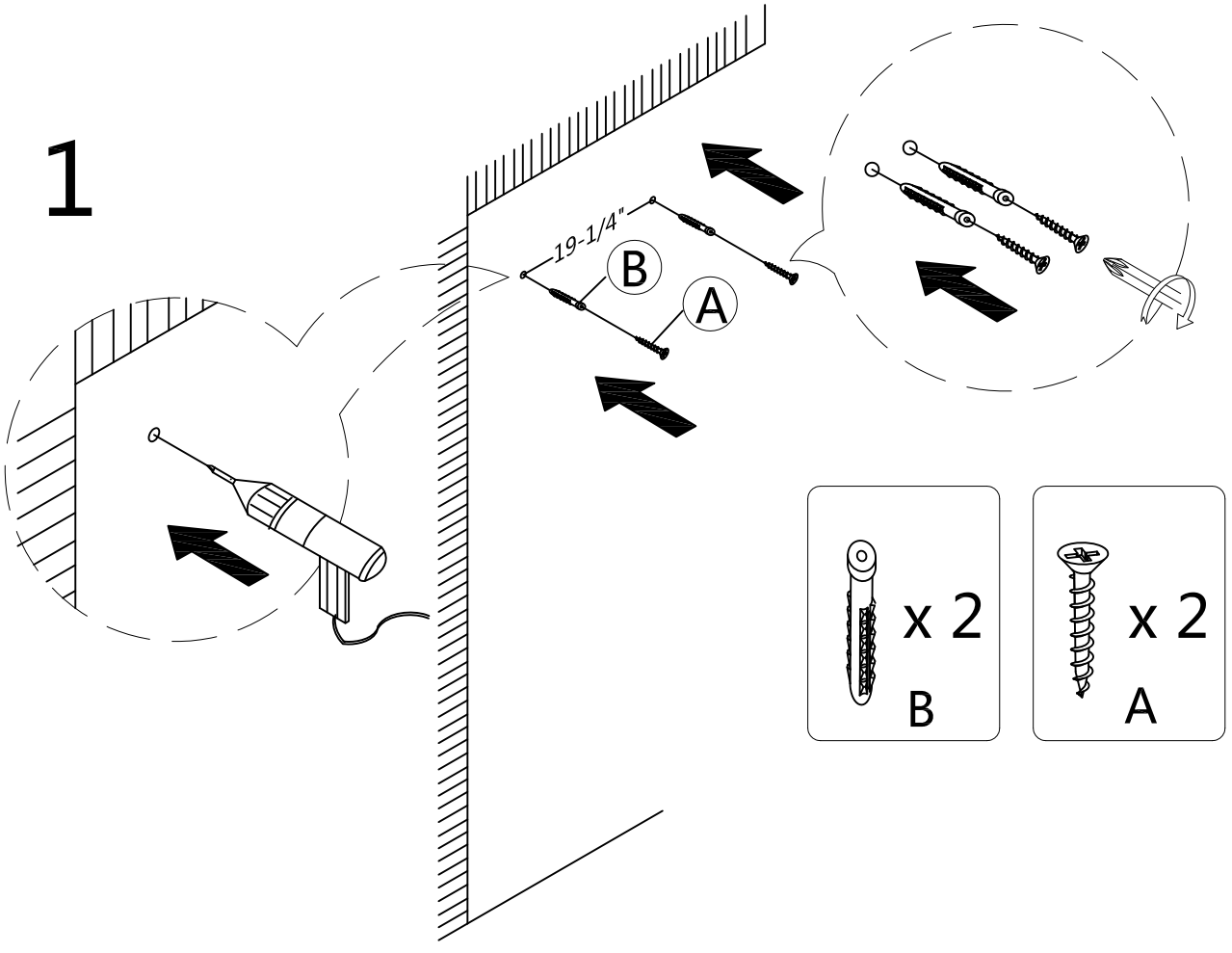

2

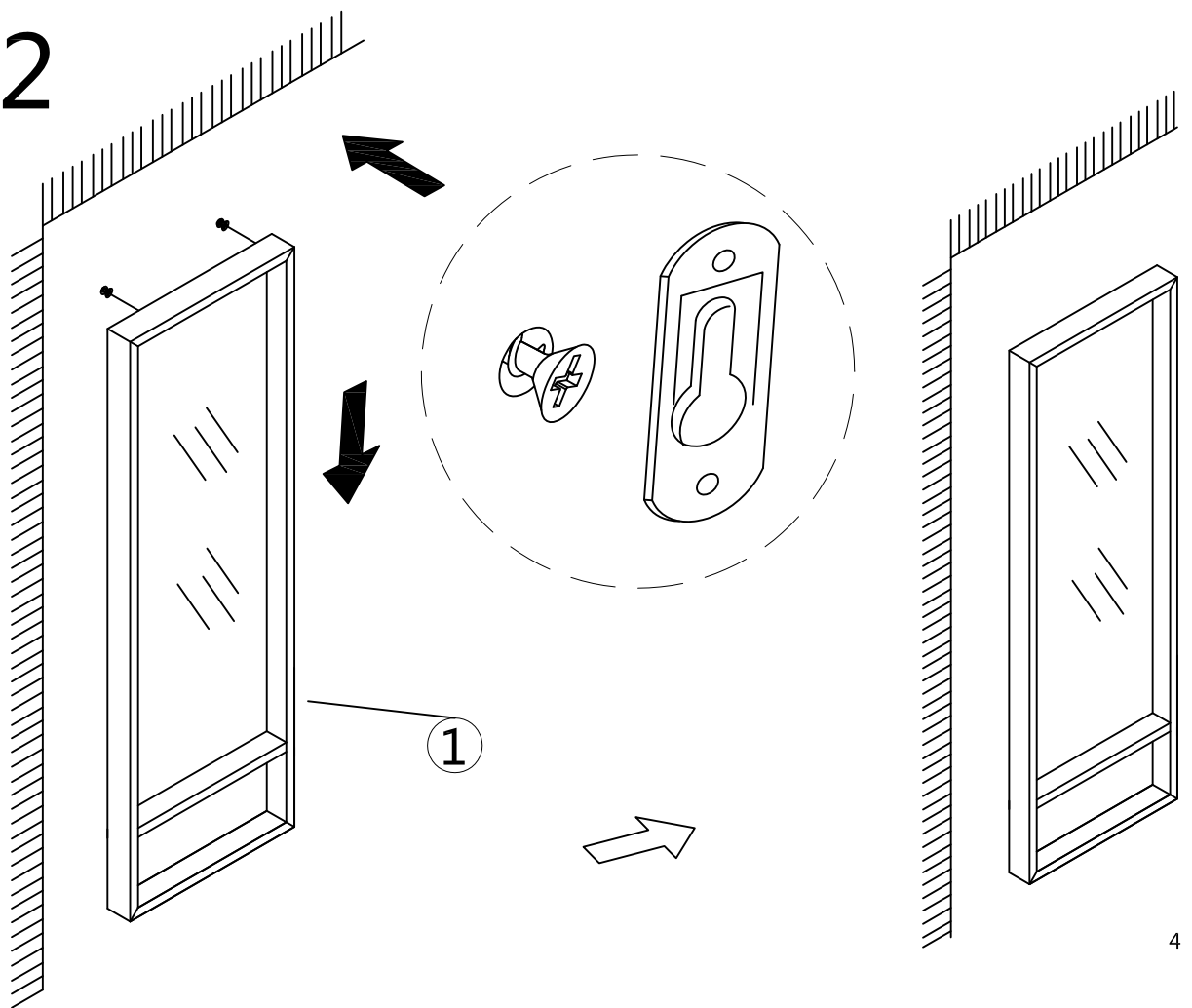

3

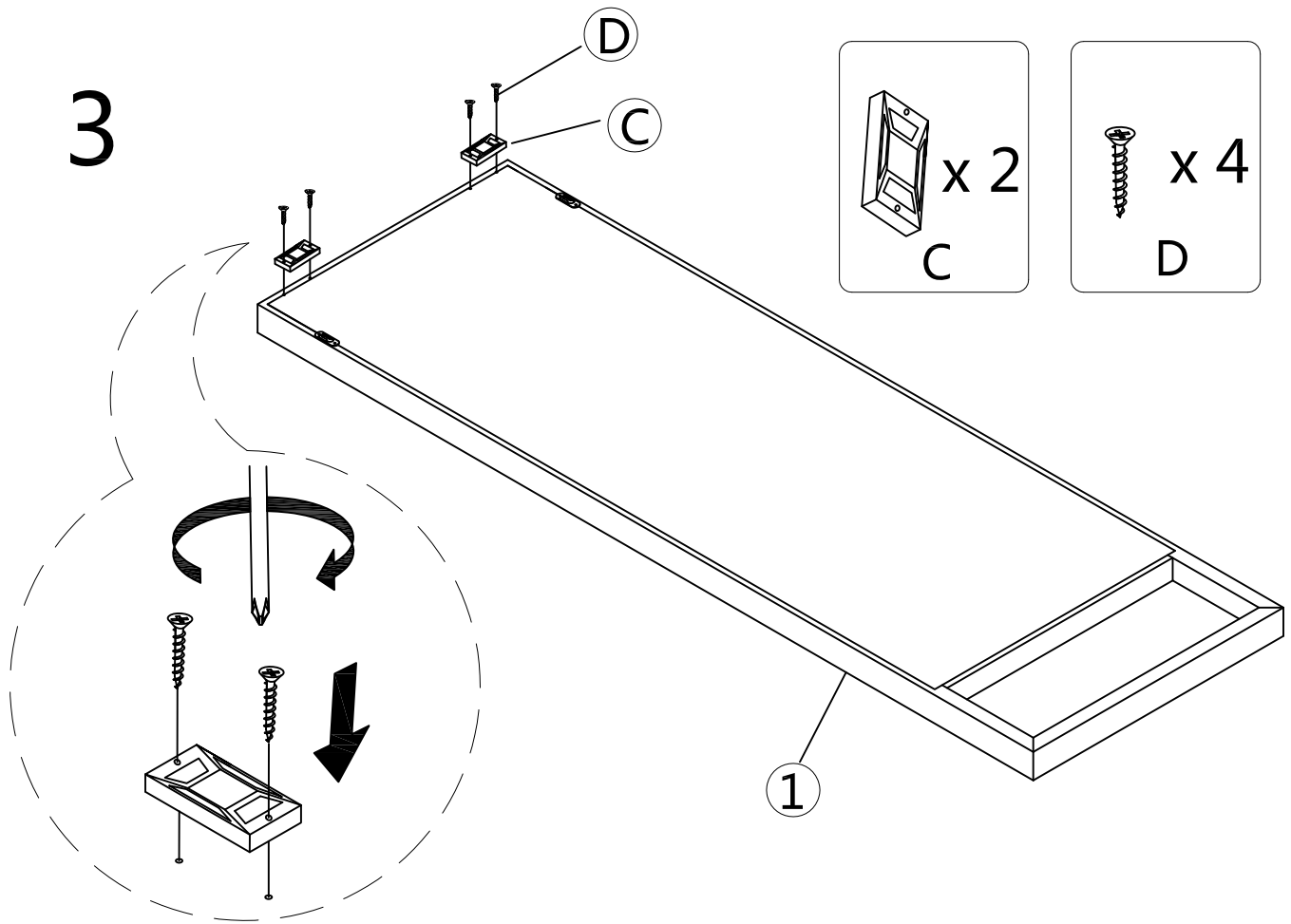

4

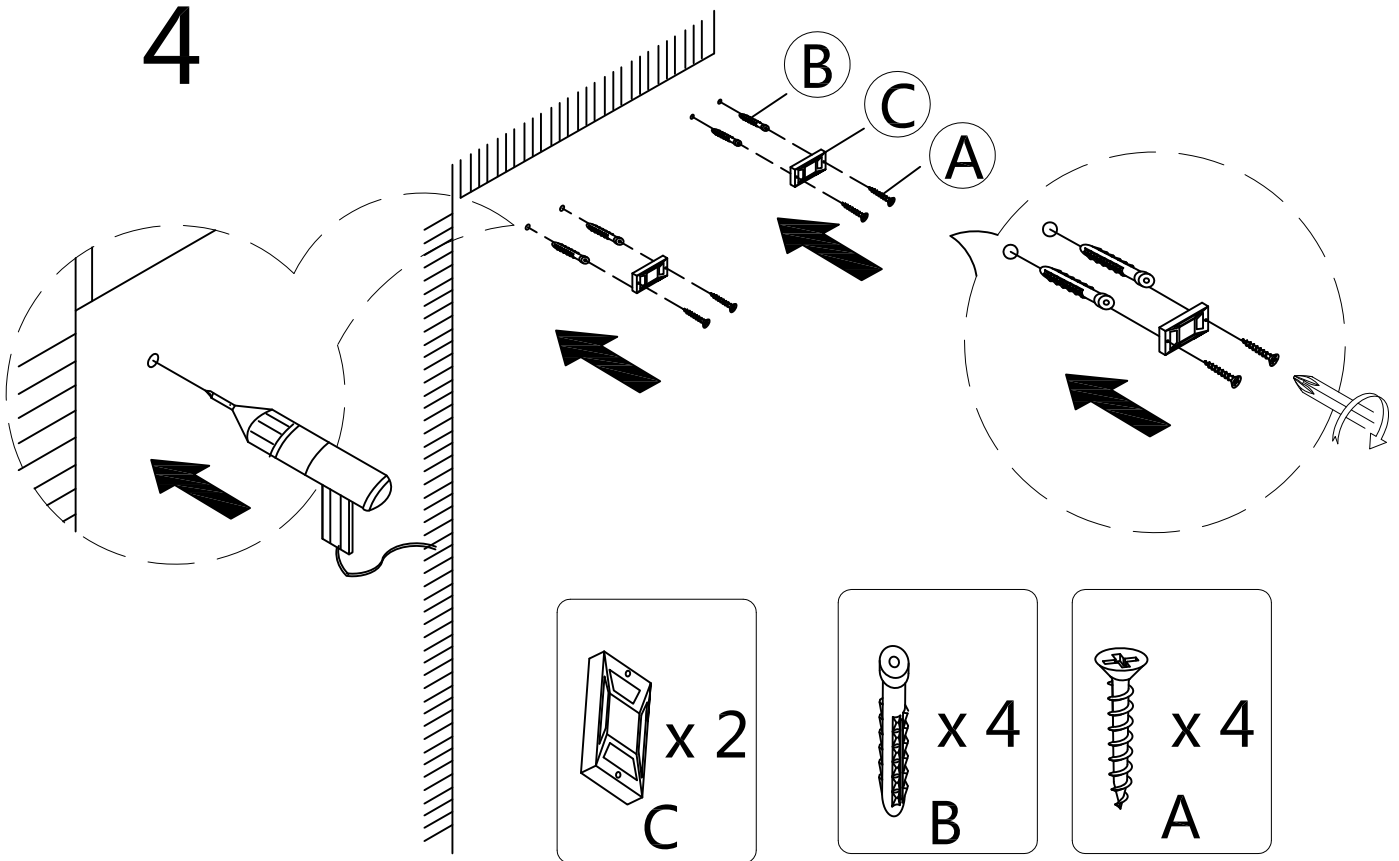

5

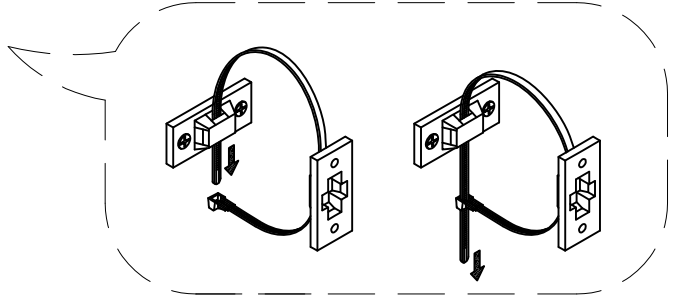
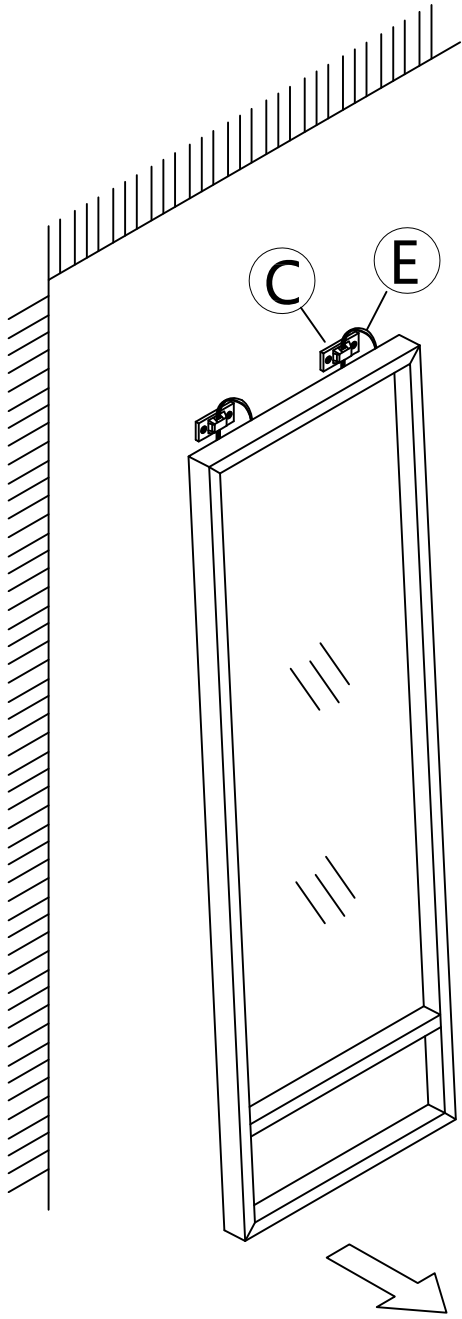

$P \times 2$
E

