

Thank you for purchasing this quality product. Be sure to check all packing material carefully for small part that may have come loose inside the carton during shipment.  
Merci d'avoir acheté ce produit de qualité. Veuillez vérifier soigneusement tous les matériaux d'emballage pour tout petit élément qui aurait pu se détacher dans le carton pendant le transport.

# ASSEMBLY INSTRUCTIONS

## INSTRUCTIONS DE MONTAGE

### TWIN BED

### LIT JUMEAU

**This set includes 1 box. If you do not receive it, please contact our customer service team.**

**Ce produit comprend 1 colis. Si vous ne le recevez pas, veuillez contacter notre service clientèle.**

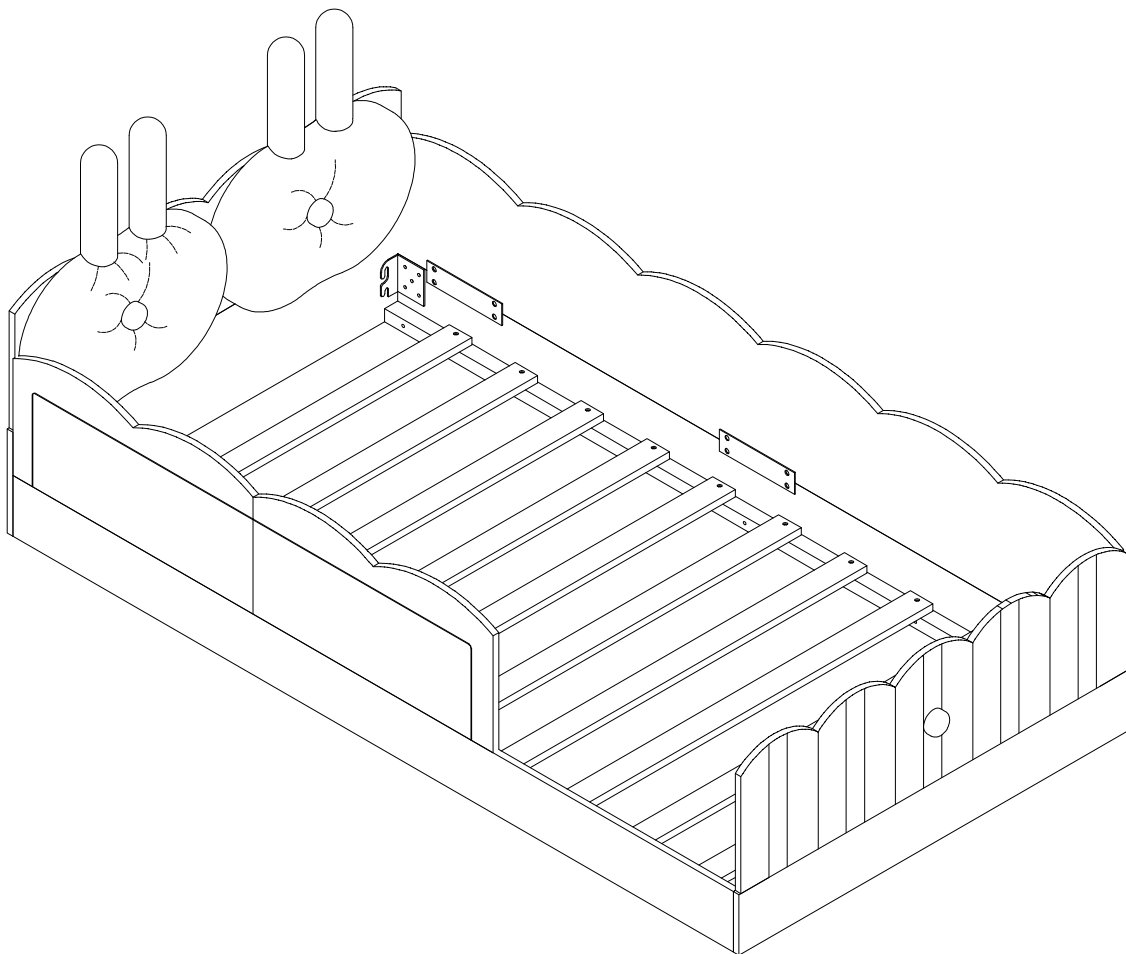

N709P337277

Thank you for purchasing this quality product. Be sure to check all packing material carefully for small part that may have come loose inside the carton during shipment.  
Merci d'avoir acheté ce produit de qualité. Veuillez vérifier soigneusement tous les matériaux d'emballage pour tout petit élément qui aurait pu se détacher dans le carton pendant le transport.

# Detail View

## Vue Détaillée

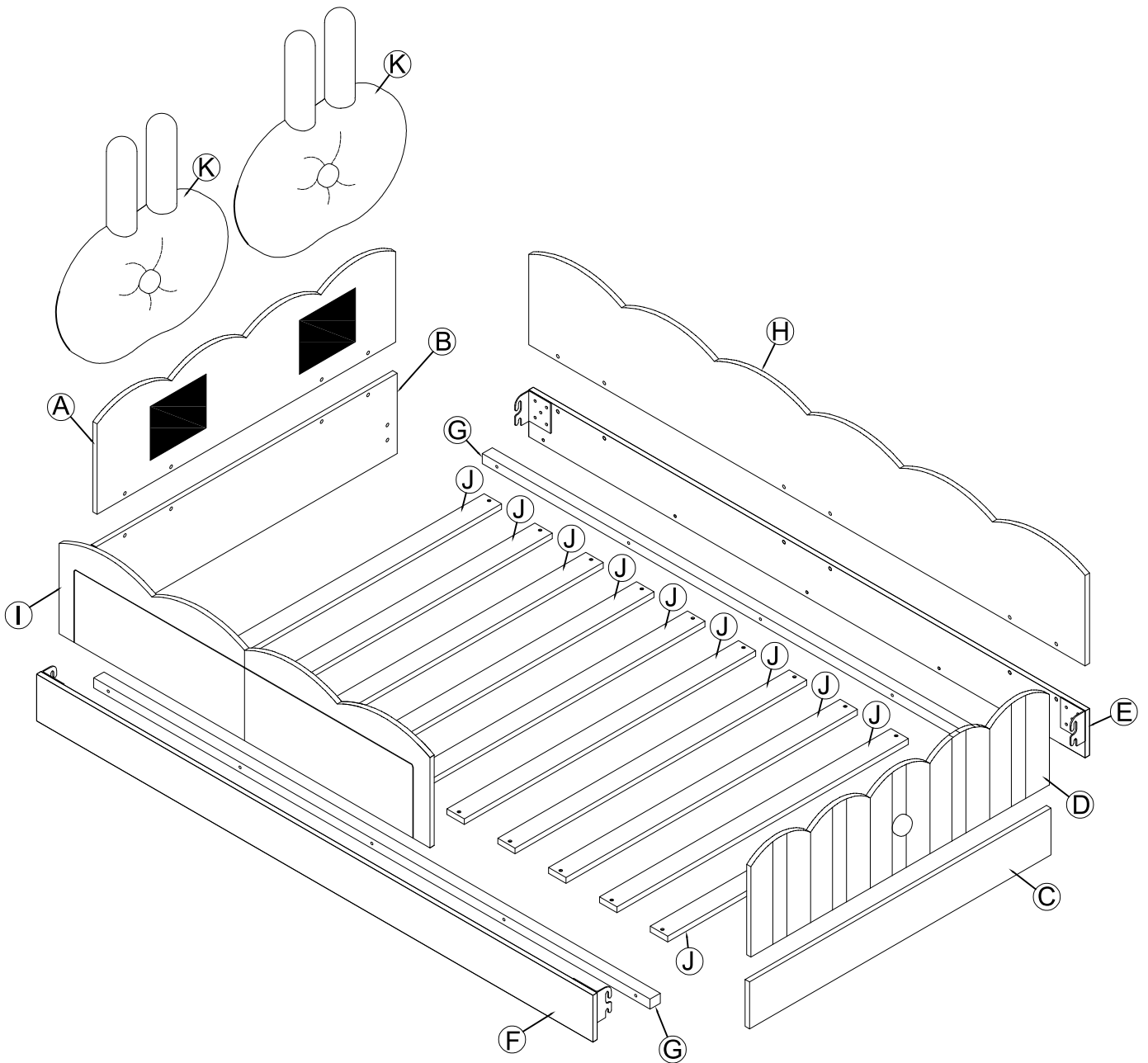







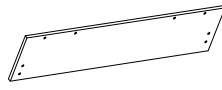

Thank you for purchasing this quality product. Be sure to check all packing material carefully for small part that may have come loose inside the carton during shipment.

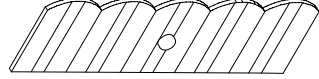
Merci d'avoir acheté ce produit de qualité. Veuillez vérifier soigneusement tous les matériaux d'emballage pour tout petit élément qui aurait pu se détacher dans le carton pendant le transport.



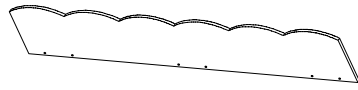
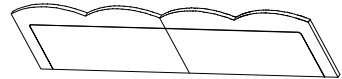
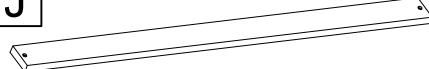



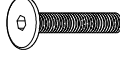

## Part List for (N709P337277)

### Liste des Pièces

<p><b>A</b></p>  <p>Upholstered Headboard - 1PC Tête de lit rembourrée</p>	<p><b>B</b></p>  <p>Headboard panel - 1PC Panneau de tête de lit</p>	<p><b>C</b></p>  <p>Footboard panel - 1PC Panneau de pied de lit</p>
<p><b>D</b></p>  <p>Upholstered Footboard - 1PC Pied de lit rembourré</p>	<p><b>E</b></p>  <p>Right side rail - 1PC Longeron droit</p>	<p><b>F</b></p>  <p>Left side rail - 1PC Longeron gauche</p>
<p><b>G</b></p>  <p>Slat support bar - 2PCS Barre de support pour lattes</p>	<p><b>H</b></p>  <p>Right Upholstered side rail - 1PC Longeron rembourré droit</p>	<p><b>I</b></p>  <p>Left Upholstered side rail - 1PC Longeron rembourré gauche</p>
<p><b>J</b></p>  <p>Slat - 10PCS Latte</p>	<p><b>K</b></p>  <p>Rabbit head pillow - 2PCS Coussin tête de lapin</p>	

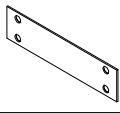
## Hardware List (N709P337277)

### Liste des Accessoires

<p><b>1</b></p>  <p>5/16*15mm Hex-Head bolts (44pcs) Boulons à tête hexagonale</p>	<p><b>2</b></p>  <p>1/4*45mm Hex-Head bolts (10pcs) Boulons à tête hexagonale</p>	<p><b>3</b></p>  <p>5/16 Lock washer (44pcs) Rondelle élastique</p>
<p><b>4</b></p>  <p>5/16*19mm Flat washer (44pcs) Rondelle plate</p>	<p><b>5</b></p>  <p>1/4 Lock washer (10pcs) Rondelle élastique</p>	<p><b>6</b></p>  <p>1/4*19mm Flat washer (10pcs) Rondelle plate</p>
<p><b>7</b></p>  <p>Flat metal plate (9pcs) Plaque métallique plate</p>	<p><b>8</b></p>  <p>L-Pad Metal (3pcs) L-Pad en métal</p>	<p><b>9</b></p>  <p>Ø4*30mm Screw (20pcs) Vis</p>
<p><b>10</b></p>  <p>Ø4*15mm Screw (12pcs) Vis</p>	<p><b>11</b></p>  <p>4mm Allen Key (1pc) Clé hexagonale</p>	

ASSEMBLY TOOLS REQUIRED ( NOT INCLUDED )

OUTILS D'ASSEMBLAGE REQUIS (NON INCLUS)



( Phillip head screwdriver )



PLEASE BE CAREFUL DO NOT DAMAGE THE HOLE POSITION WHEN YOU USE POWER TOOLS !

NE PAS UTILISER DES OUTILS ÉLECTRIQUES POUR ASSEMBLER CE PRODUIT !

Thank you for purchasing this quality product. Be sure to check all packing material carefully for small part that may have come loose inside the carton during shipment.

Merci d'avoir acheté ce produit de qualité. Veuillez vérifier soigneusement tous les matériaux d'emballage pour tout petit élément qui aurait pu se détacher dans le carton pendant le transport.





**Step 1 :**

1.1 Attach the Upholstered Headboard (A) to the Headboard panel (B) using Flat metal plate (7) Hex-Head bolts(1), Lock washer (3), and flat washer (4). Allen Key (11) Check and fully tighten the bolts at this step.

1.2 Attach Hex-Head bolts(1), Lock washer (3), and flat washer (4) to the headboard panel (B). Do not fully tighten the bolts at this step.

1.1 Fixez la tête de lit rembourrée (A) au panneau de tête de lit (B) à l'aide des Plaque métallique plate (7) boulons à tête hexagonale (1), des rondelles de sécurité (3) et des rondelles plates (4). Utilisez la clé Allen (11). Vérifiez et serrez complètement les boulons à cette étape.

1.2 Fixez les boulons à tête hexagonale (1), les rondelles de sécurité (3) et les rondelles plates (4) au panneau de tête de lit (B). Ne serrez pas complètement les boulons à cette étape.

<b>1</b>	<b>3</b>	<b>4</b>	<b>7</b>	<b>11</b>
				
12pcs	12pcs	12pcs	2pcs	1pc

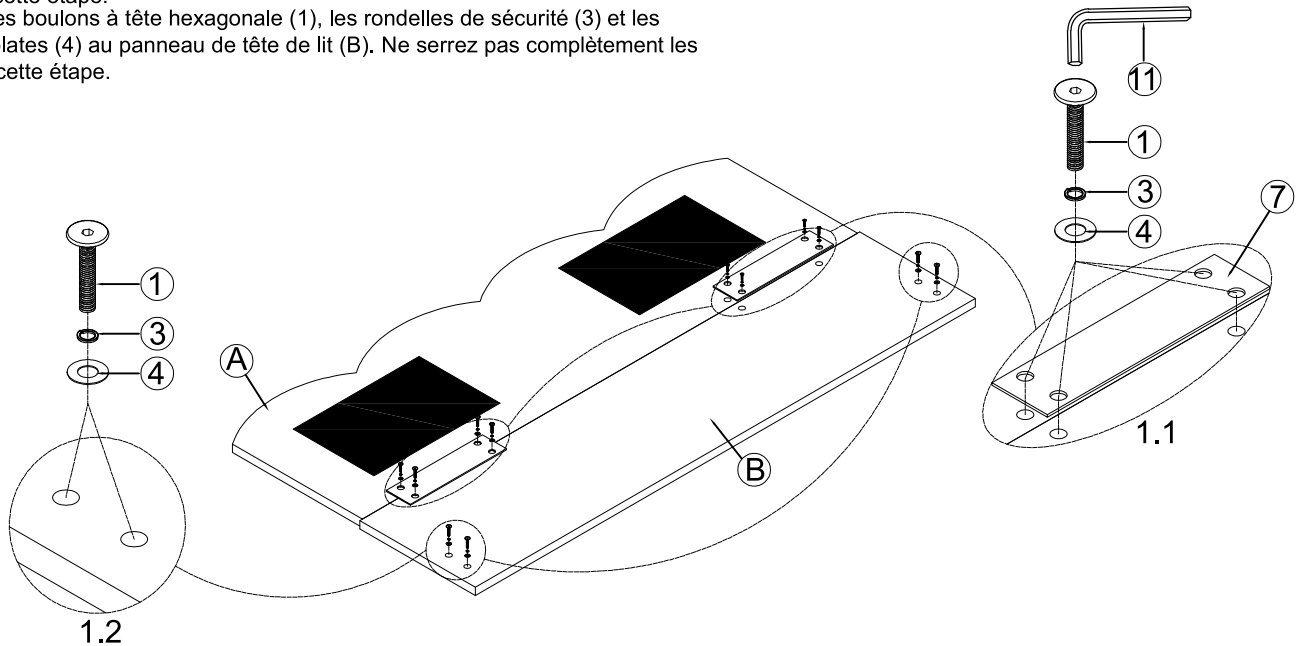





**Step 2 :**

2.1 Attach the Upholstered Footboard (D) to the Footboard panel (C) using Flat metal plate (7) Hex-Head bolts(1), Lock washer (3), and flat washer (4). Allen Key (11) Check and fully tighten the bolts at this step.

2.2 Attach Hex-Head bolts(1), Lock washer (3), and flat washer (4) to the Footboard panel (C). Do not fully tighten the bolts at this step.

2.1 Fixez le Pied de lit rembourré (D) au Panneau de pied de lit (C) à l'aide des Plaque métallique plate (7) boulons à tête hexagonale (1), des rondelles de sécurité (3) et des rondelles plates (4). Utilisez la clé Allen (11). Vérifiez et serrez complètement les boulons à cette étape.

2.2 Fixez les boulons à tête hexagonale (1), les rondelles de sécurité (3) et les rondelles plates (4) au Panneau de pied de lit (C). Ne serrez pas complètement les boulons à cette étape.

<b>1</b>	<b>3</b>	<b>4</b>	<b>7</b>	<b>11</b>
				
12pcs	12pcs	12pcs	2pcs	1pc

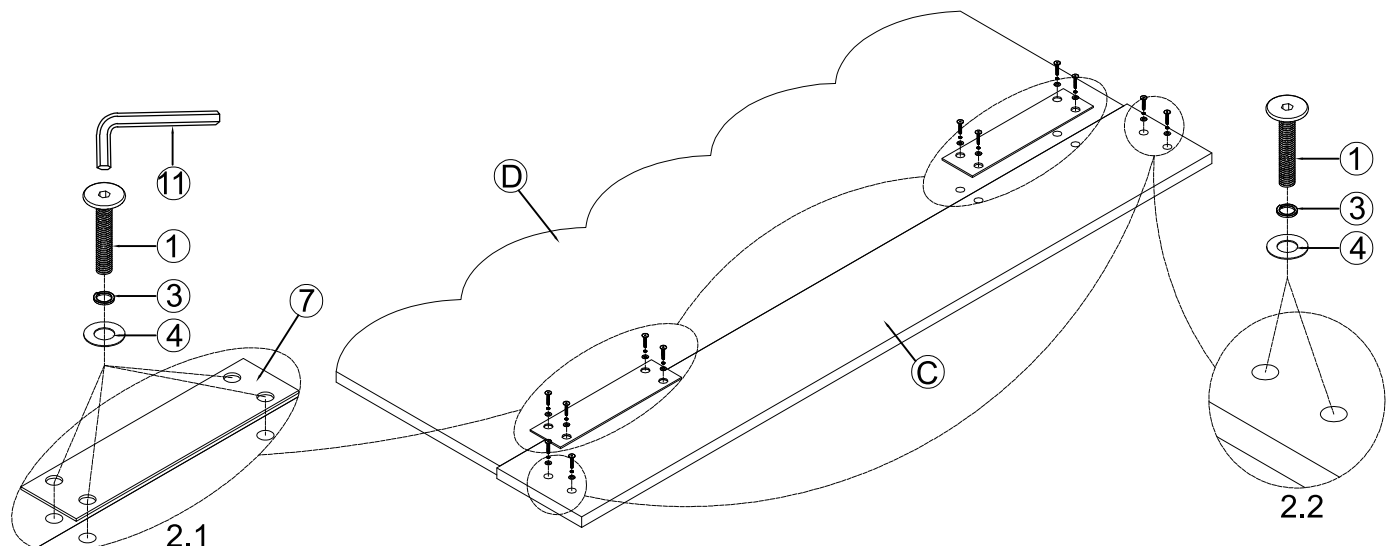





Thank you for purchasing this quality product. Be sure to check all packing material carefully for small part that may have come loose inside the carton during shipment.

Merci d'avoir acheté ce produit de qualité. Veuillez vérifier soigneusement tous les matériaux d'emballage pour tout petit élément qui aurait pu se détacher dans le carton pendant le transport.

**Step 3 :**

Attach the Slat support bar (G) to the Right side rail (E) and Left side rail (F) using Hex-Head bolts (2), Lock washer (5), and flat washer (6). Allen Key (11) Check and fully tighten the bolts at this step.

Fixez la barre de support de lattes (G) au rail latéral droit (E) et au rail latéral gauche (F) à l'aide des boulons à tête hexagonale (2), des rondelles de sécurité (5) et des rondelles plates (6). Utilisez la clé Allen (11). Vérifiez et serrez complètement les boulons à cette étape.



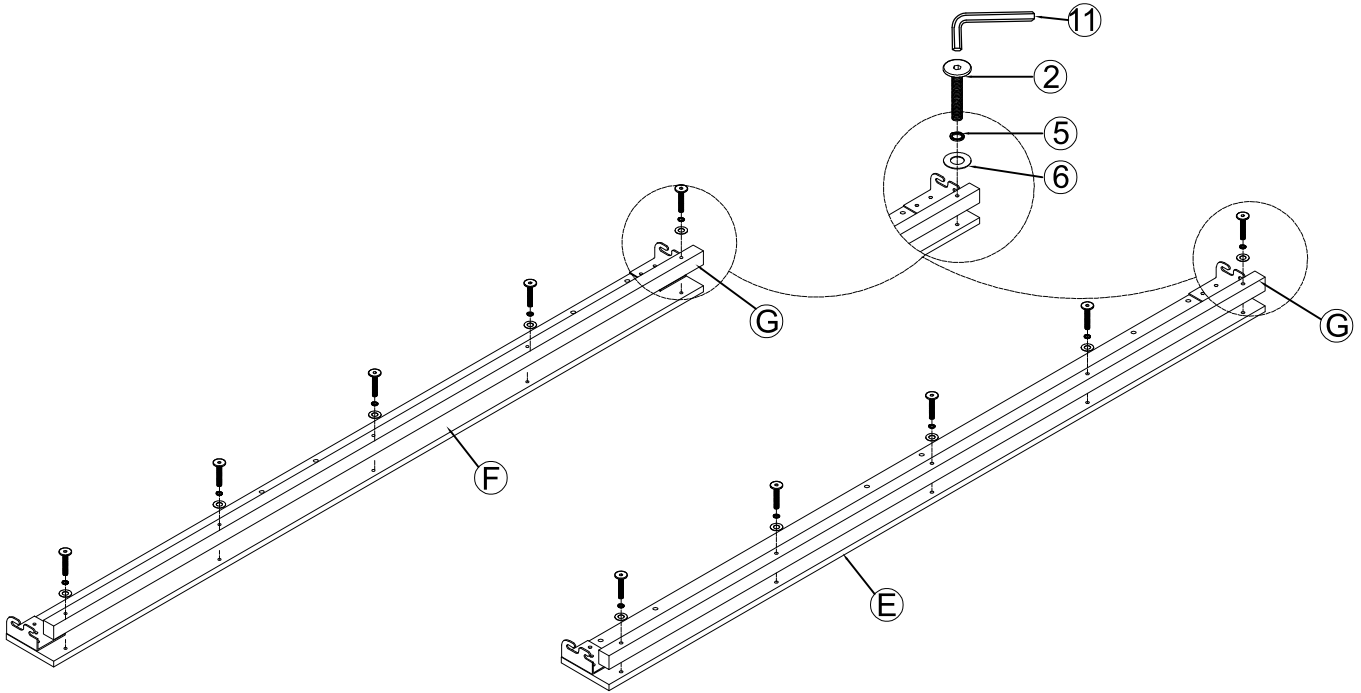

<b>2</b>	<b>5</b>	<b>6</b>	<b>11</b>
			
10pcs	10pcs	10pcs	1pc



**Step 4 :**

Attach the Right Upholstered side rail (H) to the right side rail (E) in Step 3 using Flat metal plate (7) Hex-Head bolts(1), Lock washer (3), and flat washer (4). Allen Key (11) Check and fully tighten the bolts at this step.

Fixez le panneau latéral droit rembourré (H) au panneau latéral droit (E) à l'étape 3 à l'aide de la plaque métallique plate (7), des boulons à tête hexagonale (1), des rondelles de sécurité (3) et des rondelles plates (4). Utilisez la clé Allen (11). Vérifiez et serrez complètement les boulons à cette étape.

<b>1</b>	<b>3</b>	<b>4</b>	<b>7</b>	<b>11</b>
				
12pcs	12pcs	12pcs	3pcs	1pc

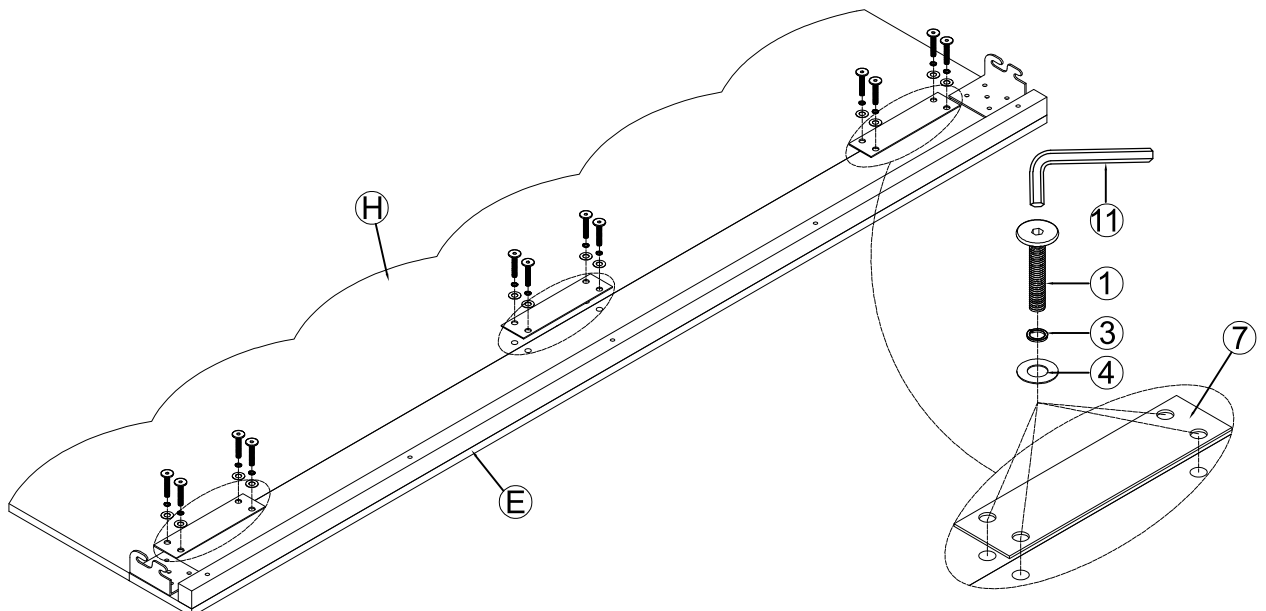





Thank you for purchasing this quality product. Be sure to check all packing material carefully for small part that may have come loose inside the carton during shipment.

Merci d'avoir acheté ce produit de qualité. Veuillez vérifier soigneusement tous les matériaux d'emballage pour tout petit élément qui aurait pu se détacher dans le carton pendant le transport.

**Step 5 :**

Attach the Left Upholstered side rail (I) to the Left side rail (F) in Step 3 using Flat metal plate (7) Hex-Head bolts(1), Lock washer (3), and flat washer (4).Allen Key (11) Check and fully tighten the bolts at this step.

Fixez le panneau latéral gauche rembourré (I) au panneau latéral gauche (F) à l'étape 3 à l'aide de la plaque métallique plate (7), des boulons à tête hexagonale (1), des rondelles de sécurité (3) et des rondelles plates (4). Utilisez la clé Allen (11). Vérifiez et serrez complètement les boulons à cette étape.

<b>1</b>	<b>3</b>	<b>4</b>	<b>7</b>	<b>11</b>
				
8pcs	8pcs	8pcs	2pcs	1pc

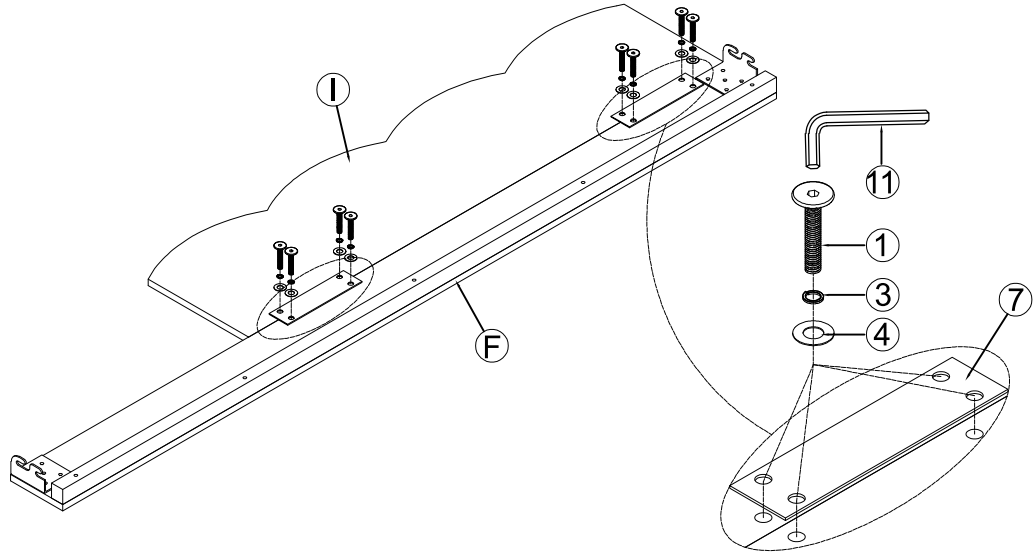

**Step 6 :**

Attach the right side rail in Step 4, and the left side rail in Step 5, to the headboard in Step 1 and the footboard in Step 2 using side rail hook brackets and Allen Key (11). Check and fully tighten the bolts at this step

Fixez le panneau latéral droit à l'étape 4, et le panneau latéral gauche à l'étape 5, à la tête de lit à l'étape 1 et au pied de lit à l'étape 2 à l'aide des supports à crochet pour panneaux latéraux et de la clé Allen (11). Vérifiez et serrez complètement les boulons à cette étape.

<b>11</b>

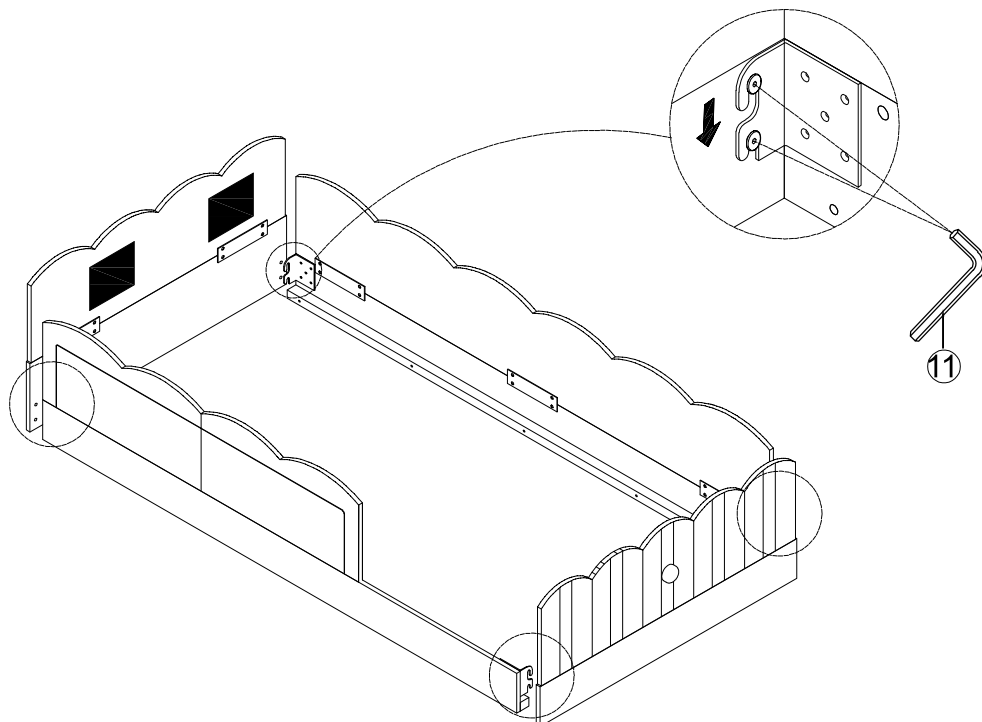
1pc





Thank you for purchasing this quality product. Be sure to check all packing material carefully for small part that may have come loose inside the carton during shipment.

Merci d'avoir acheté ce produit de qualité. Veuillez vérifier soigneusement tous les matériaux d'emballage pour tout petit élément qui aurait pu se détacher dans le carton pendant le transport.

### Step 7 :

Attach L-Pad Metal(8) to the corner joint between the side rail and the headboard/footboard using screws (10). Be careful not to overtighten.

Fixez la plaque métallique en L (8) à l'angle de jonction entre le panneau latéral et la tête de lit/pied de lit à l'aide des vis (10). Faites attention à ne pas trop serrer.

8	10
	
3pcs	12pcs

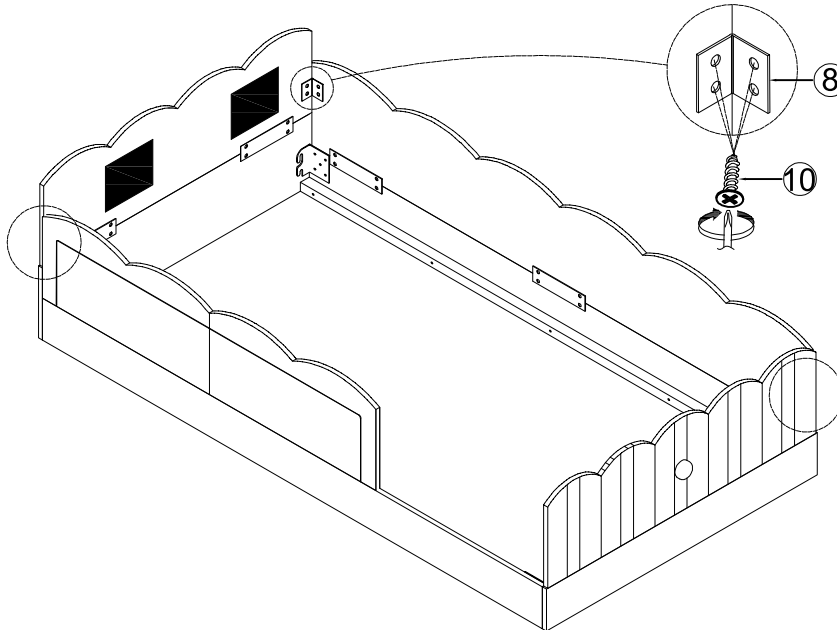

### Step 8 :

Attach the bed slats (J) to the right side rail and the left side rail using screws (9). Be careful not to overtighten.

Fixez les lattes du sommier (J) au rail latéral droit à l'aide des vis (9). Veillez à ne pas trop serrer.

9

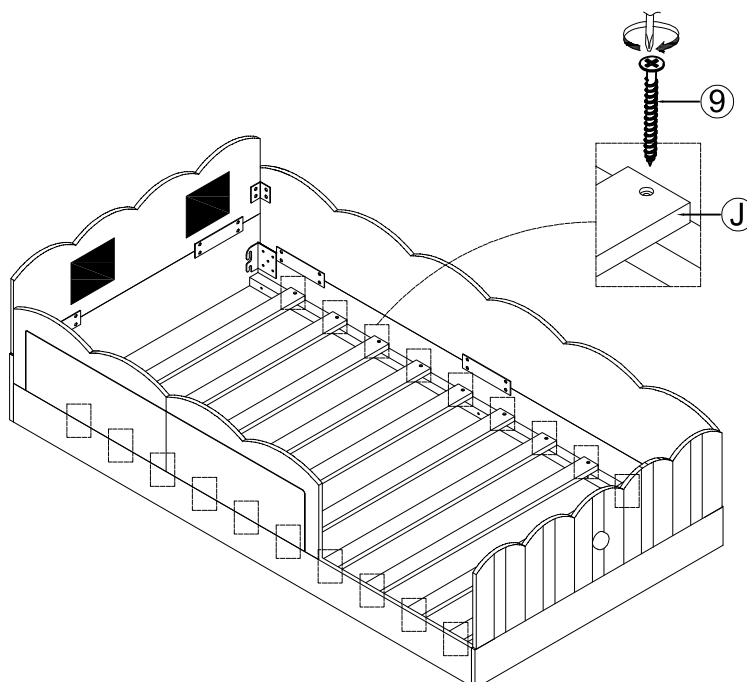
20pcs



Thank you for purchasing this quality product. Be sure to check all packing material carefully for small part that may have come loose inside the carton during shipment.

Merci d'avoir acheté ce produit de qualité. Veuillez vérifier soigneusement tous les matériaux d'emballage pour tout petit élément qui aurait pu se détacher dans le carton pendant le transport.

**Step 9 :**

Stick the Rabbit head pillow (K) onto the headboard and on the back of the cushion.

Collez le coussin en forme de tête de lapin (K) sur la tête de lit à l'aide des bandes adhésives fournies sur la tête de lit et à l'arrière du coussin.

