

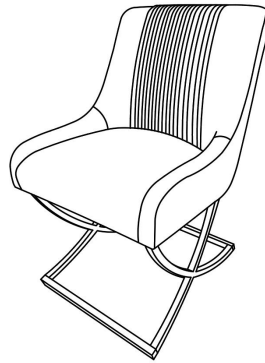

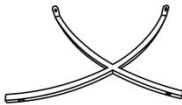

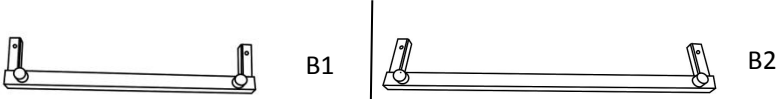

ACCENT CHAIR

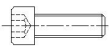

PARTSLIST		
LABEL	PICTURE	QTY
A		2
B		2
B-L		1
HARDWARE		
LABEL	PICTURE	QTY
C	 M6X12	4
D		1
E	 M6X20	4
F		4

Step1

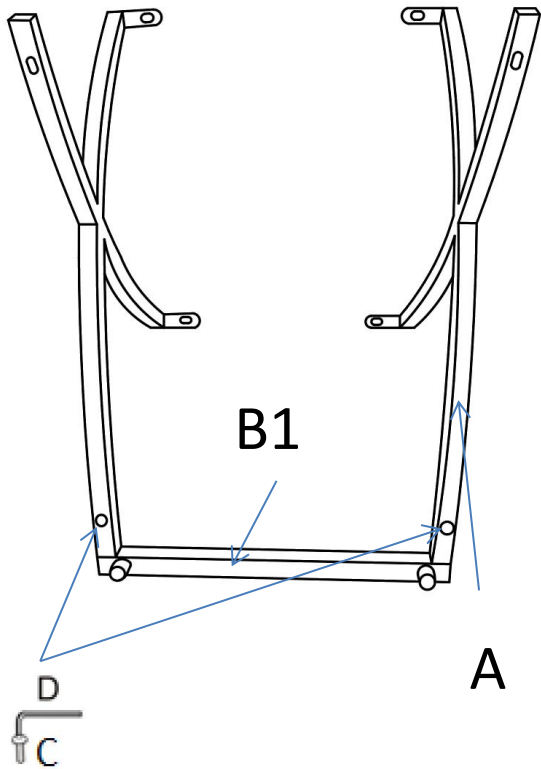

Step2

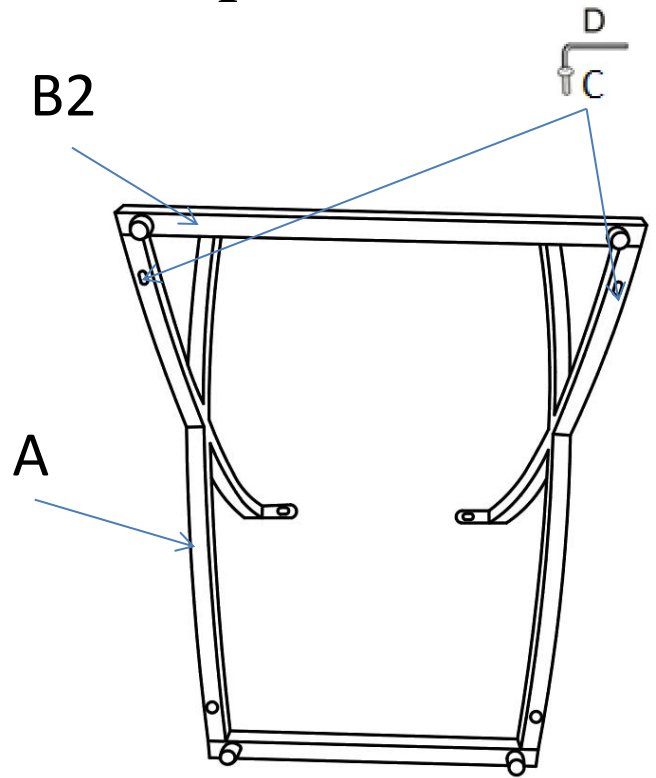

Step3

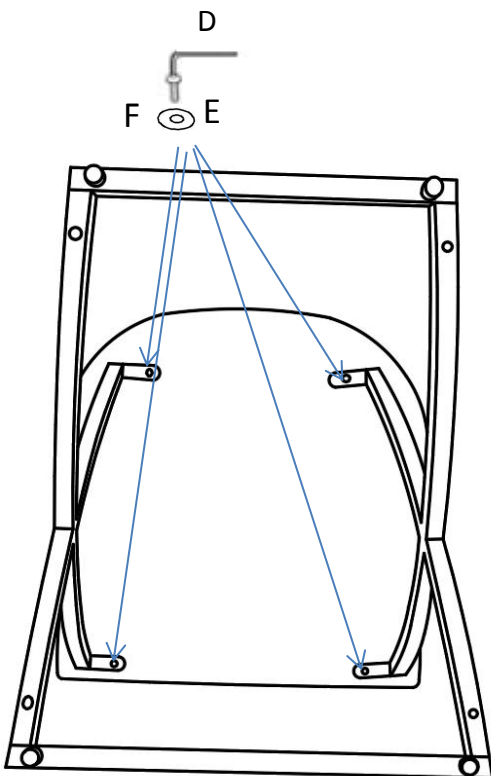

Step4

