

COFFEE MAKER

INSTRUCTION MANUAL



ITEM NO.: CM3751S

MODEL NO.: CM9451-UL

Thank you for purchasing this product! If you have questions about the product such as missing parts,damaged products,product assembling and operation etc., please contact us via Amazon Message or customer service phone: 213-4467172 or 661-4358826.

IMPORTANT SAFEGUARDS

When using electrical appliance. Basic safety precautions should always be followed including the following:

1. Read all instructions.
2. Make sure that your outlet voltage corresponds to the voltage stated on the rating label of the coffee maker.
3. To protect against fire, electric shock and injury to person do not immerse cord, plug, or in water or other liquid.
4. Close supervision is necessary when any appliance is used by or near children.
5. Unplug from outlet when not in use and before cleaning. Allow to cooling before putting on or taking off parts, and before cleaning the appliance.
6. Do not operate any appliance with a damaged cord or plug or after the appliance malfunctions, or has been damaged in any manner. Return appliance to an authorized service facility for examination, repair or adjustment.
7. The use of accessory not recommended by the appliance manufacturer may result in fire, electric shock or injury to persons.
8. Do not use outdoors.
9. Do not let cord hang over edge of table or counter, or touch hot surface.
10. Do not place on or near a hot gas or electric burner, or in a heated oven.
11. Do not use appliance for other than intended use.
12. Do not clean container with cleansers, steel wool pads, or other abrasive material.
13. To disconnect, turn any control to "OFF", remove plug from wall outlet. Always hold the plug. But never pull the cord.
14. Scalding may occur if the cover is removed during the brewing cycles. Be careful not to get burned by the steam.
15. Some parts of appliance are hot when operated, so do not touch with hand. Use handles or knobs only.
16. Never leave the empty carafe on the warming plate otherwise the carafe is liable to crack.
17. Never use the appliance if the carafe shows any signs of cracks or carafe having a loose or weakened handle. Only use the carafe with this appliance. Use carefully as the carafe is very fragile.
18. This appliance is not intended for used by persons (including children) with reduced physical, sensory or mental capabilities, or lack of experience and knowledge, unless they have been given supervision or instruction concerning use of the appliances by a person responsible for their safety.

19. Children should be supervised to ensure that they do not play with the appliance.
20. Do not set a hot container on a hot or cold surface.
21. Do not let the coffee maker operate without water.
22. The container is designed for use with this appliance. It must never be used on a range top.
23. Risk of Fire or Electric Shock. Do not remove this cover. No user service-able parts inside. Repair should be done by authorized service personnel only.

SAVE THESE INSTRUCTIONS HOUSEHOLD USE ONLY

NOTES ON THE CORD PLUG

This appliance has a polarized plug, To reduce the risk of electric shock, this plug is intended to fit into a polarized outlet only one way, If the plug does not fit fully into the outlet, reverse the plug, if it still does not fit, contact a qualified electrician, Do not attempt to modify the plug in any way.

NOTES ON THE POWER CORD

- a) A short power-supply cord (or detachable power-supply cord) is provided to reduce risks resulting from becoming entangled in or tripping over a longer cord.
- b) Longer detachable power-supply cords or extension cords are available and may be used if care is exercised in their use.
- c) If a long detachable power-supply cord or extension cord is used:
 - 1) The marked electrical rating of the detachable power-supply cord or extension cord should be at least as great as the electrical rating of the appliance;
 - 2) If the appliance is of the grounded type, the extension cord should be a grounding type 3-wire cord;
 - 3) The longer cord should be arranged so that it will not drape over the counter top or table top where it can be pulled on by children or tripped over.

	WARNING RISK OF FIRE OR ELECTRIC SHOCK DO NOT OPEN	
<p>WARNING: TO REDUCE THE RISK OF FIRE OR ELECTRIC SHOCK, DO NOT REMOVE COVER (OR BACK) NO USER-SERVICEABLE PARTS INSIDE REPAIR SHOULD BE DONE BY AUTHORIZED SERVICE PERSONNEL ONLY</p>		



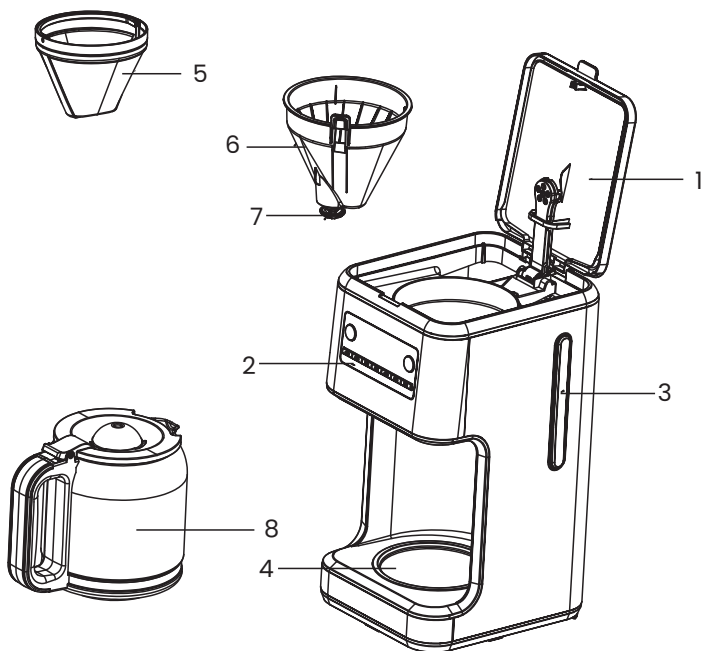



KNOW YOUR COFFEE MAKER

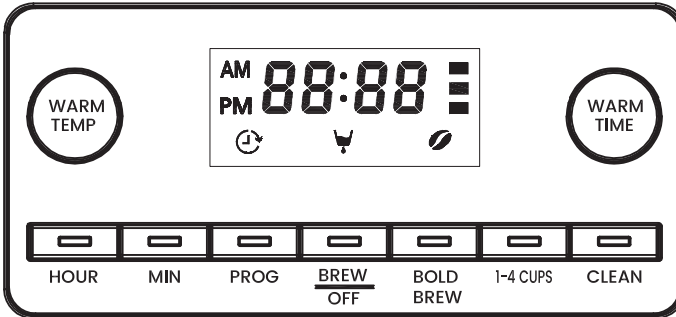



- | | |
|----------------------|--------------------|
| 1. Top cover | 5. Filter |
| 2. Control panel | 6. Funnel |
| 3. Water level gauge | 7. Anti-drip valve |
| 4. Warming plate | 8. Carafe |

CONTROL PANEL



"  ": This button is used for adjusting the warming temperature. The default setting of warming temperature is "  ". And you can press "  " to select your desired warming temperature. There are three warming temperatures including High setting "  " ($\geq 176^{\circ}\text{F}$), Medium setting "  " ($167^{\circ}\text{F}-176^{\circ}\text{F}$) and Low setting "  " ($158^{\circ}\text{F}-167^{\circ}\text{F}$) for selection.

"  ": It is the display for showing the icons for the corresponding selected functions.

"  ": This button is used for adjusting the warming time, which includes 1H, 2H, 3H and 4H.

" HOUR ": This button is used for adjusting the Hour of the time. One hour can be increased after every press of the "HR" button. Hold and press the "HR" button for 2 seconds to increase the hour fast.

" MIN ": This button is used for adjusting the Minute of the time. One minute can be increased after every press of the "MIN" button. Hold and press the "MIN" button for 2 seconds to increase the minute fast.

" PROG ": This button is used for setting the "Delay Brew" function.

"  ": It is On/Off button. Press the On/Off button, the appliance enters into the working status. Press the On/Off button again, the appliance enters into the standby mode.

" **BOLD BREW** ": This button is used for activating the "Bold Brew" function.

"1-4 CUPS": This button is used to brew less than 5 cups of coffee, and the appliance will adjust the brew process for maximum flavor extraction under the "1-4 cups" mode.

" **CLEAN** ": This button is used for activating the "Clean" function.

BEFORE USING THE APPLIANCE FOR THE FIRST USE

Check that all accessories are complete and the appliance is not damaged. Fill the water tank with water to the MAX level and brew water for several times without ground coffee, then discard the water. Clean and dry all detachable parts thoroughly according to the section "CLEANING AND MAINTENANCE".

USING YOUR COFFEE MAKER



1. Open the top cover and fill the water tank with drinking water. The water level should not exceed the MAX level as indicated in the water tank.
2. Place the funnel into the funnel support, make sure it is assembled correctly, otherwise the top cover cannot be closed. Place the filter in the funnel.
3. Add ground coffee into the filter. Usually a cup of coffee needs a level spoon of coffee powder, but you may adjust according to personal taste. Close the top cover completely.

NOTE: The amount of coffee brewed will always be slightly less than the amount of water poured in the water tank. This is due to the minimum absorption of water by the coffee grounds.

4. Insert the carafe on the warming plate horizontally.
5. Insert the power plug into the outlet. The display will show "12:00 AM", "12 00 AM" blink while " : " illuminates solidly, at that time, all the LED indicators do not illuminate.
6. Press the On/Off button " $\frac{\text{BREW}}{\text{OFF}}$ ", its corresponding indicator illuminates and the icon " " shown in the display illuminates, and the appliance starts to work.

NOTE: The brewing process can be interrupted by pressing the On/Off button " $\frac{\text{BREW}}{\text{OFF}}$ " at any time, and the appliance will continue brewing once the On/Off button " $\frac{\text{BREW}}{\text{OFF}}$ " is pressed down again.

7. After the coffee-brewing is completed, remove the carafe and pour the coffee for serving.

8. To make stronger coffee, simply press the “**BOLD BREW**” button, its corresponding indicator illuminates and the icon “” shown in the display illuminates, then the appliance enters into the mode for making stronger coffee. Press the On/Off button “**BREW OFF**”, its corresponding indicator illuminates and the icon “” shown in the display illuminates, and the appliance starts to work.

NOTE: The “Strong Brew” function can be only canceled within 5 seconds after the “**BOLD BREW**” button is pressed down.

9. If brewing fewer than 5 cups, simply press the “**1-4 CUPS**” button, its corresponding indicator illuminates, and the appliance will adjust the brew process for maximum flavor extraction under the “1-4 cups” mode. Press the On/Off button “**BREW OFF**”, its corresponding indicator illuminates and the icon “” shown in the display illuminates, and the appliance starts to work.

NOTE: The “1-4 cups” function can be only canceled within 5 seconds after the “**1-4 CUPS**” button is pressed down.

10. When the brewing process is completed, if you do not want to serve immediately, keep the coffee maker energized, and the coffee in the carafe can be kept warm on the warming plate for 2 hours by default, and the appliance will power off automatically after 2 hours if it has not been manually disconnected at the end of brewing. And you can adjust the warming time and warming temperature by following the operation specified in the section of “CUSTOMIZING THE WARMING PLATE”. For an optimum coffee taste, serve it just after brewing.

11. Always turn off the coffee maker and disconnect the power supply when not use.

NOTE: Pay attention to pour the coffee out, otherwise you may be hurt as the temperature of coffee just finished is high.

CUSTOMIZING THE WARMING PLATE

1. To adjust how long it stays warm, press the “” button to select the desired warming time including 4 hours, 3 hours, 2 hours and 1 hour.

NOTE: The warming time can be adjusted when it does not exceed one hour during the keep-warm process.

2. To adjust the temperature of the warming plate, press the “” button to select the desired warming temperature including High, Medium or Low.

DELAY BREW

If you do not want the coffee maker to start working immediately, for example now it is 8:10 AM, you hope that the coffee maker will automatically start at 1:10 PM in the afternoon, firstly follow the operations of Step 1 to 5 above, then you can set the Delay Brew function as follows:

1. Press the "HR" and "MIN" buttons to set the current time, that is 8:10 AM.

NOTE: The time cycle is 12 hours.

2. Press "PROG" button once, the indicator of "PROG" button, the time and the icon "⌚" shown in the display blink.

3. Press the "HR" and "MIN" buttons to set the auto-start time, that is 1:10 PM.

4. After setting the auto-start time, press "PROG" button again, and the appliance enters into the delay brew mode, at that time, the indicator of "PROG" button and the display illuminate solidly.

5. When the auto-start time is reached, the appliance starts to work.

NOTE: The delay brew function can be canceled if "PROG" button is pressed again during working.

CLEANING AND MAINTENANCE

CAUTION: Be sure to unplug this appliance before cleaning. To protect against electrical shock, do not immerse cord, plug or the appliance into water or liquid. After each use, always make sure the plug is removed from wall outlet firstly.

1. Clean all detachable parts after each use in hot, sudsy water.

2. Wipe the product's exterior surface with a soft, damp cloth to remove stains.

3. Water droplets may buildup in the area above the funnel and drip onto the product base during brewing. To control the dripping, wipe the area with a clean, dry cloth after each use of the product.

4. Use a damp cloth to gently wipe the warming plate. Never use abrasive cleaner to clean it.

5. Replace all parts and keep for next use.

Maintenance

Any other servicing should be performed by an authorized service representative.

REMOVING MINERAL DEPOSITS

Minerals (calcium/limestone) found in water will leave deposits in your coffee maker and can affect performance.

1. When it is time to perform descaling for the coffee maker, the "CLEAN" button blinks and the display shows "CLEAN".
2. Fill the water reservoir to capacity with a mixture of white vinegar and water.
3. Put the carafe on the warming plate and ensure it is placed in position.
4. Press the "CLEAN" button once, the appliance enters into the descaling procedure and starts to perform descaling, at that time, the indicator of "CLEAN" button illuminates solidly.
5. Once the solution in the water tank is boiled away, the indicator of "CLEAN" button extinguishes and the descaling is completed.
6. Refill the water tank with clean water and press the On/Off button to rinse the machine. Repeat for at least 3 times.

HINTS FOR GREAT-TASTING COFFEE

1. A clean coffee maker is essential for making great-tasting coffee. Regularly clean the coffee maker as specified in the section of "CLEANING AND MAINTENANCE" . Always use fresh, cold water in the coffee maker.
2. Store unused coffee powder at a cool, dry place. After opening a package of coffee powder, reseal it tightly and store it in a refrigerator to maintain its freshness.
3. For an optimum coffee taste, buy whole coffee beans and finely grind them just before brewing.
4. Do not reuse coffee powder since this will greatly reduce the coffee' flavor. Reheating coffee is not recommended as coffee is at its peak flavor immediately after brewing.
5. Clean the coffee maker when over-extraction causes oiliness. Small oil droplets on the surface of brewed, black coffee are due to the extraction of oil from the coffee powder.
6. Oiliness may occur more frequently if heavily roasted coffees are used.

Thank you for purchasing this product! If you have any questions about the product, such as missing parts, damaged products, product assembling, and operation, please contact us via **Amazon Message** or customer service number: **213-4467172 or 661-4358826**

IMPORTANT

Please call our customer service department for any consulting:

213-4467172

661-4358826

(8:30am - 5:30pm P.S.T.)

DATED PROOF OF PURCHASE IS REQUIRED FOR WARRANTY SERVICE.

AVIS

Veillez appeler le service à la clientèle pour toutes questions au:

213-4467172

661-4358826

(8:30am - 5:30pm P.S.T.)

PREUVE D'ACHAT ORIGINALE REQUISE POUR SERVICE DE GARANTIE.

IMPORTANTE

Sólo hay que llamar nuestro departamento de servicio al cliente en caso de tener preguntas o inquietudes:

213-4467172

661-4358826

(8:30am - 5:30pm P.S.T.)

SE REQUIERE PRUEBA DE COMPRA CON FECHA PARA SERVICIO BAJO GARANTÍA.

Address: ROWAN ELECTRIC APPLIANCE LLC

28407 Ascent Way, Santa Clarita, CA 91350

Phone: 213-4467172 or 661-4358826

