









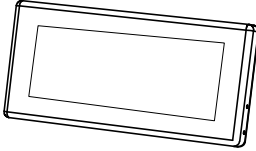

Left A package: Place A+B+C+D+E+F+G+H2

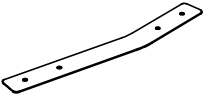
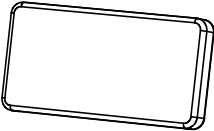
Right B package: Place A+B+C+D+F+G+H2+J+K+L+M

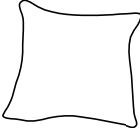
## ASSEMBLE INSTRUCTION

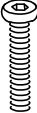
<b>A</b> x2 	<b>B</b> x2 	<b>C</b> x2 	<b>D</b> x2 
<b>E</b> x4 	<b>F</b> x2 	<b>G</b> x2 	<b>H</b> x4 
<b>J</b> x8 	<b>K</b> x16 	<b>L</b> x16 	<b>M</b> x1 

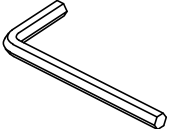
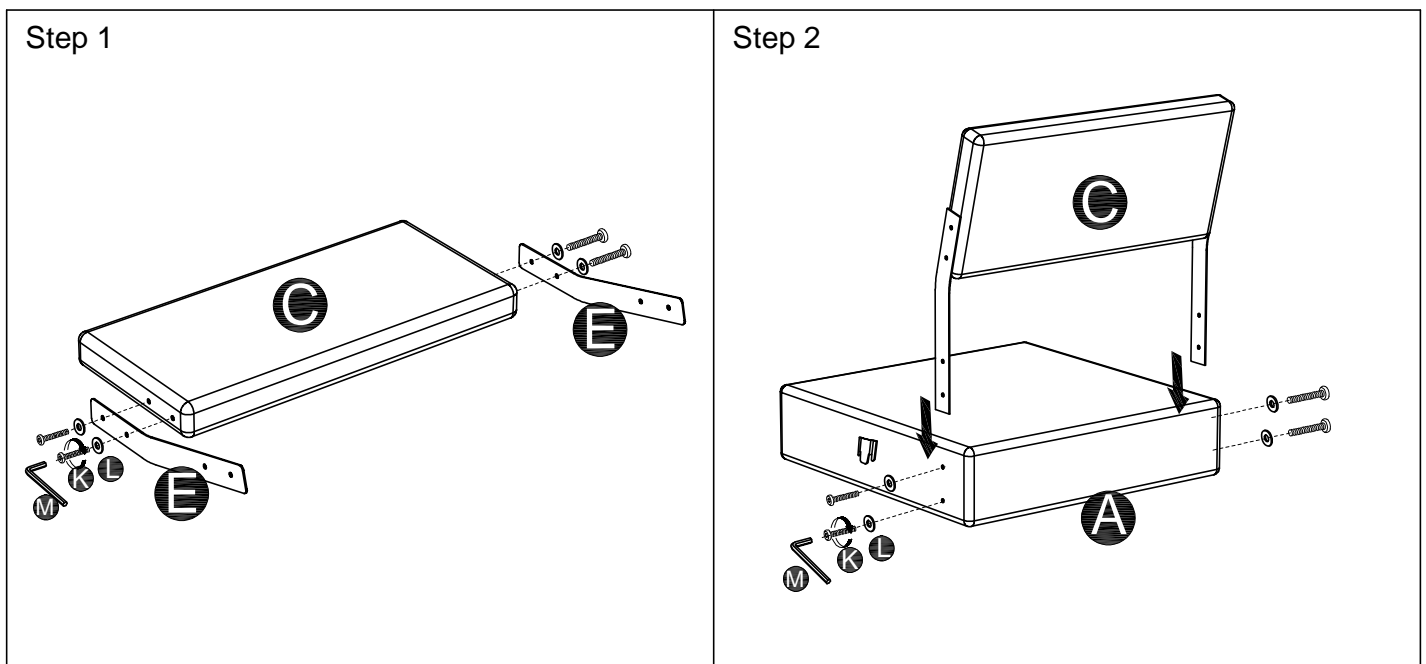

Step 3

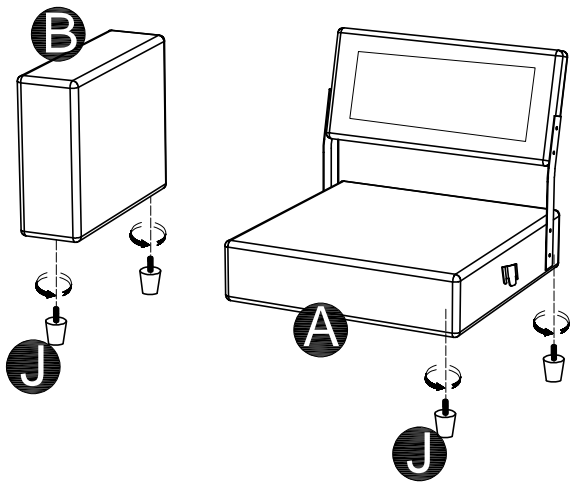

Step 4

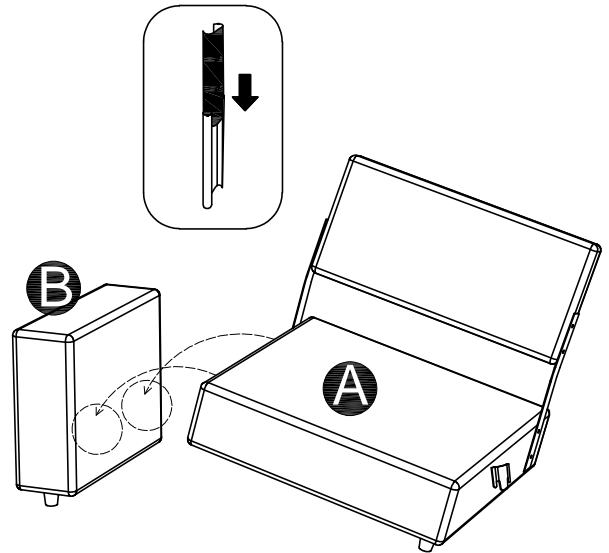

Step 5

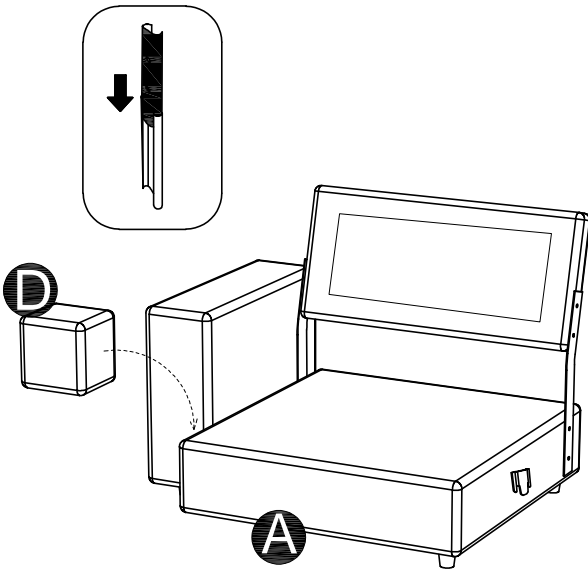

Step 6

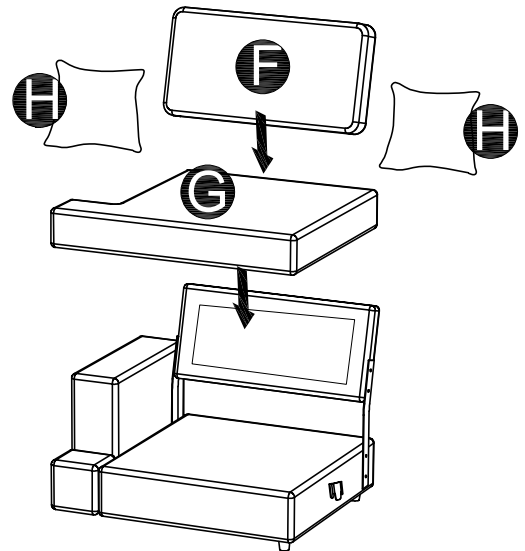

Step 7

