

Installation & Assembly

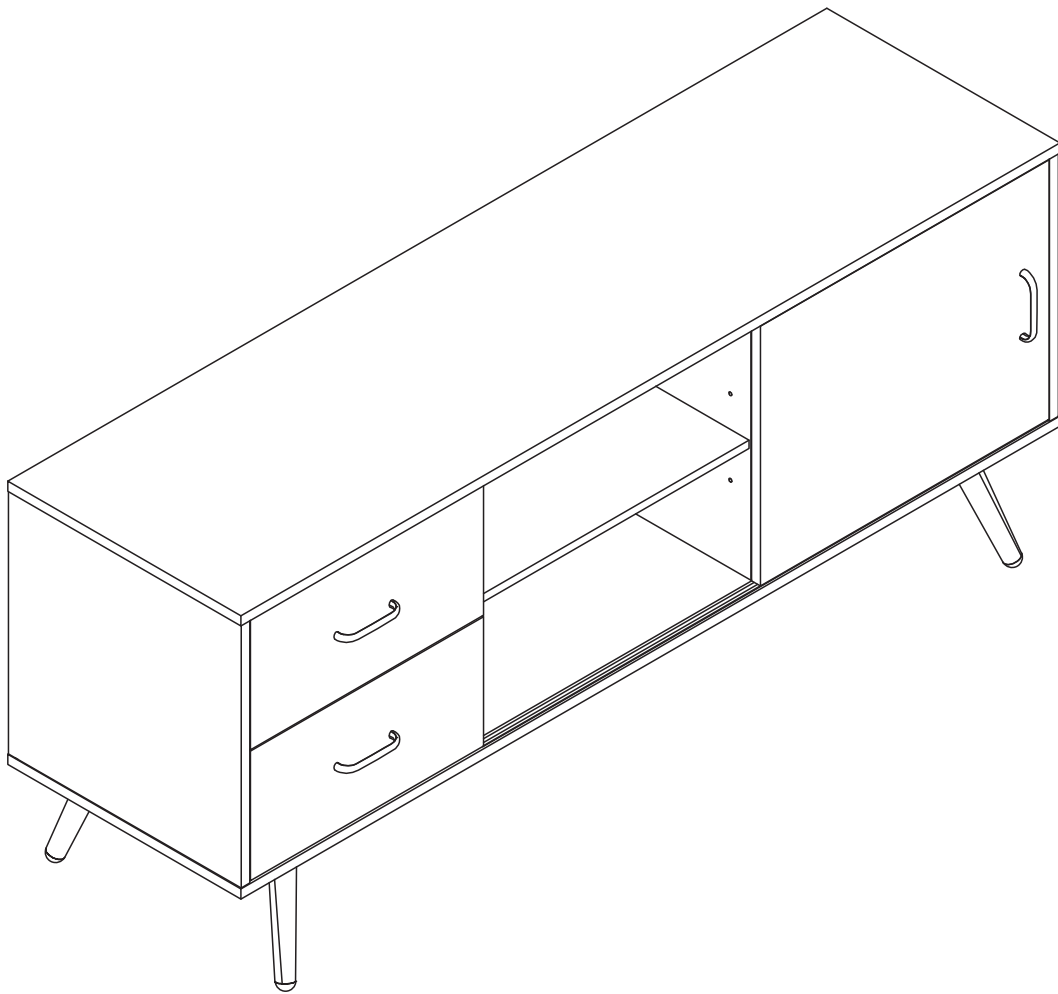

TV Cabinet

EN

Thank you for purchase. Please contact us if you have difficulty with assembly or need replacement parts.

Please attach your User Name or Order ID so that we can assist you better.

WARNING

Serious or fatal injury may occur from unexpected assembly or use.

1. During the assembly process, keep all parts away from babies or children.
2. Use of tip-over restraints may only reduce, but not eliminate the risk of tip-over.
3. Unless specially designed to accommodate, do not set heavy objects on top of this product.
4. Place the heaviest items on the lowest shelf.
5. Never allow children to climb or bang on drawers, doors or shelves.

DE

Vielen Dank für Ihren Kauf. Bitte kontaktieren Sie uns, wenn Sie Probleme mit Montage haben oder Ersatzteile benötigen.

Bitte geben Sie Ihren Benutzernamen oder Ihre Bestellnummer an, damit wir Sie besser unterstützen können.

WARNUNG







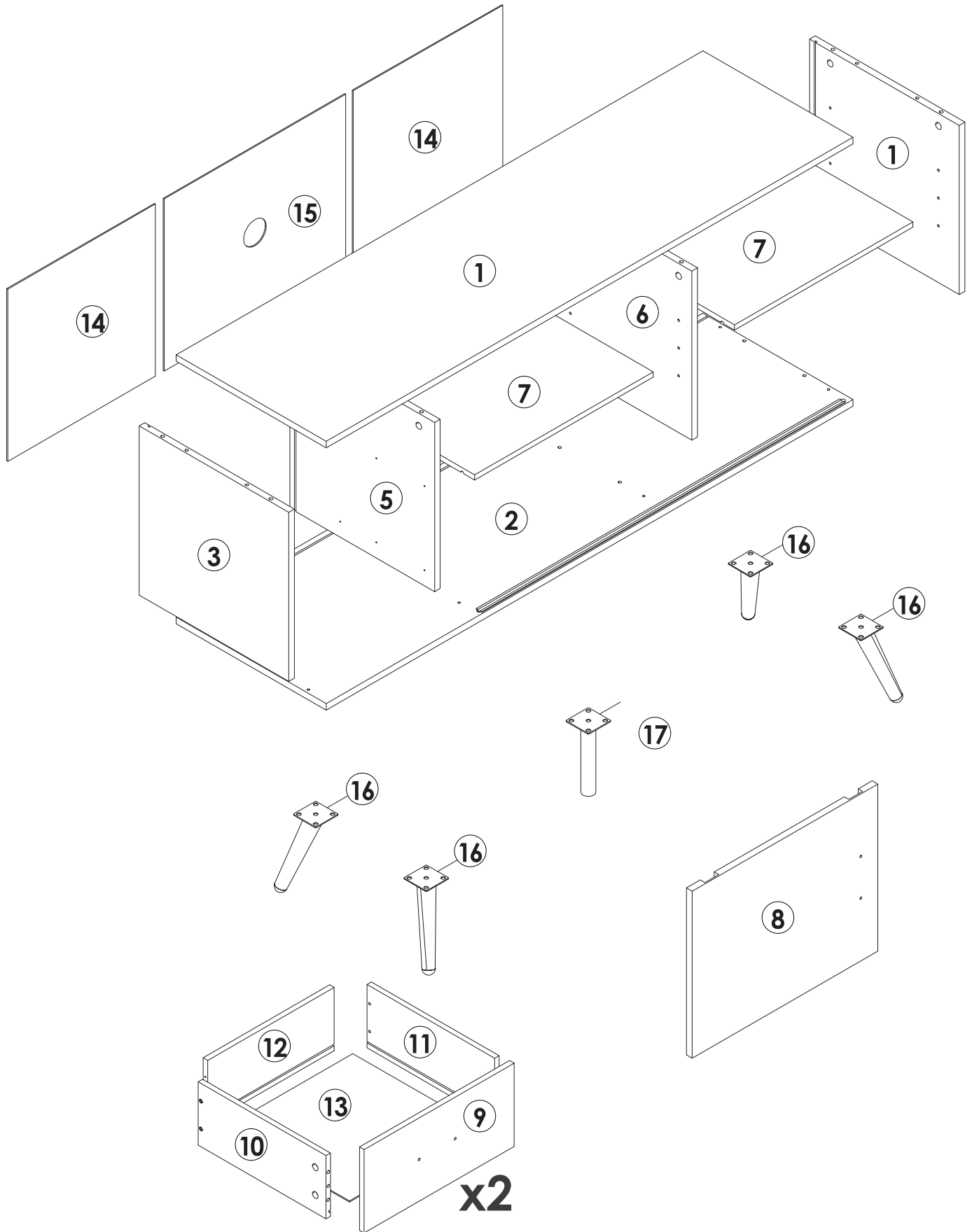

Bei unerwarteter Montage oder Verwendung können schwere oder tödliche Verletzung auftreten.

1. Legen Sie in den Montageprozess alle Teile weg von Babys oder Kindern.
2. Die Verwendung von Kippsicherungen kann die Gefahr eines Kippens nur verringern, jedoch nicht beseitigen.
3. Setzen Sie bitte keine schweren Gegenstände auf dieses Produkt, es sei denn, dass das Produkt speziell für die Unterbringung konzipiert wird.
4. Legen Sie bitte die schwersten Gegenstände auf das unterste Regal.
5. Erlauben Sie nie Kindern, auf Schubladen, Türen oder Regale zu klettern oder zu knallen.

Parts List(EN) / Teile Liste(DE)

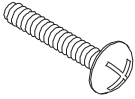
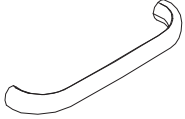
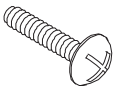
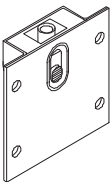
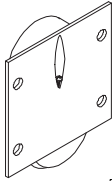

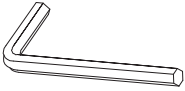
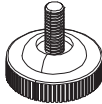

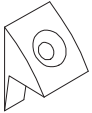
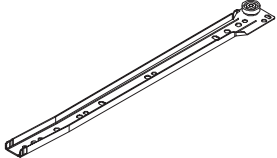
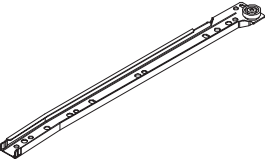
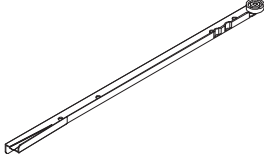
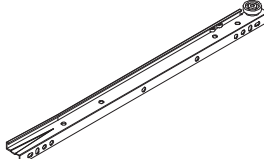

Parts List(EN) / Teile Liste(DE)

<p>A</p>  <p>M6x35mm 16PCS</p>	<p>B</p>  <p>Φ15x9.5mm 16PCS</p>	<p>C</p>  <p>M4x40mm 16PCS</p>
<p>D</p>  <p>Φ6x30mm 20PCS</p>	<p>E</p>  <p>M3x12mm 24PCS</p>	<p>F</p>  <p>M4x18mm 2PCS</p>
<p>G</p>  <p>96mm 3PCS</p>	<p>H</p>  <p>M4x16mm 4PCS</p>	<p>I</p>  <p>2PCS</p>
<p>J</p>  <p>2PCS</p>	<p>K</p>  <p>8PCS</p>	<p>L</p>  <p>M6x12mm 20PCS</p>
<p>M</p>  <p>M4 1PC</p>	<p>N</p>  <p>Φ6mm 1PC</p>	<p>O</p>  <p>Φ20mm 4PCS</p>
<p>P</p>  <p>M3x14mm 28PCS</p>	<p>Q</p>  <p>Φ15x9.5mm 12PCS</p>	<p>CL</p>  <p>L350mm 2PCS</p>
<p>CR</p>  <p>L350mm 2PCS</p>	<p>DL</p>  <p>L350mm 2PCS</p>	<p>DR</p>  <p>L350mm 2PCS</p>

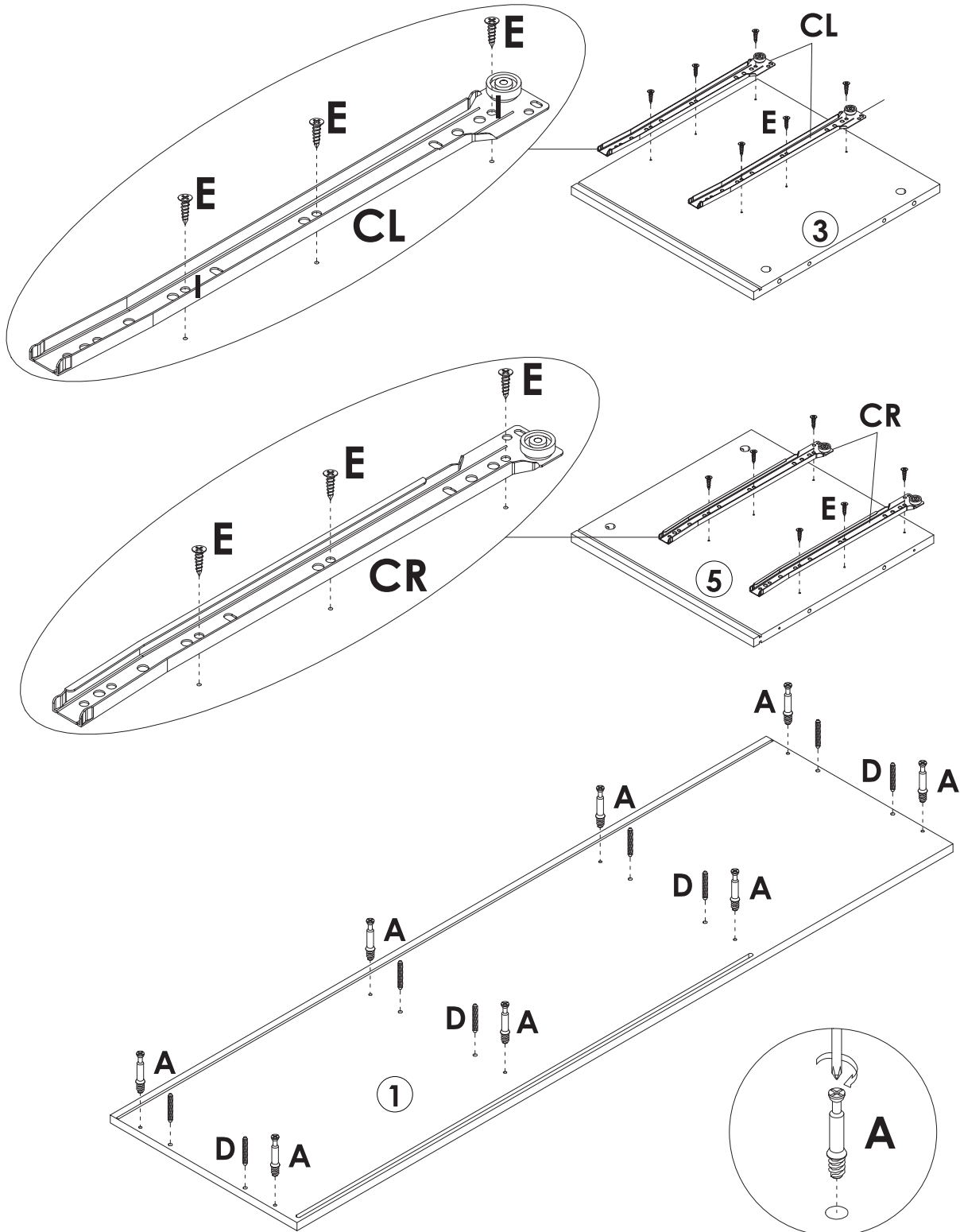
Assembly Steps(EN) / Montageschritte(DE)

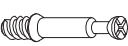
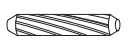
STEP 1





	A x 8PCS
	D x 8PCS
	E x 12PCS
	CL x 2PCS
	CR x 2PCS

Assembly Steps(EN) / Montageschritte(DE)

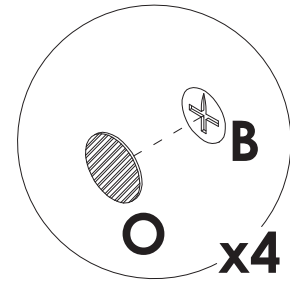
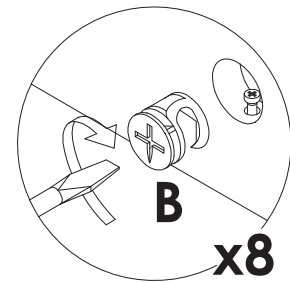
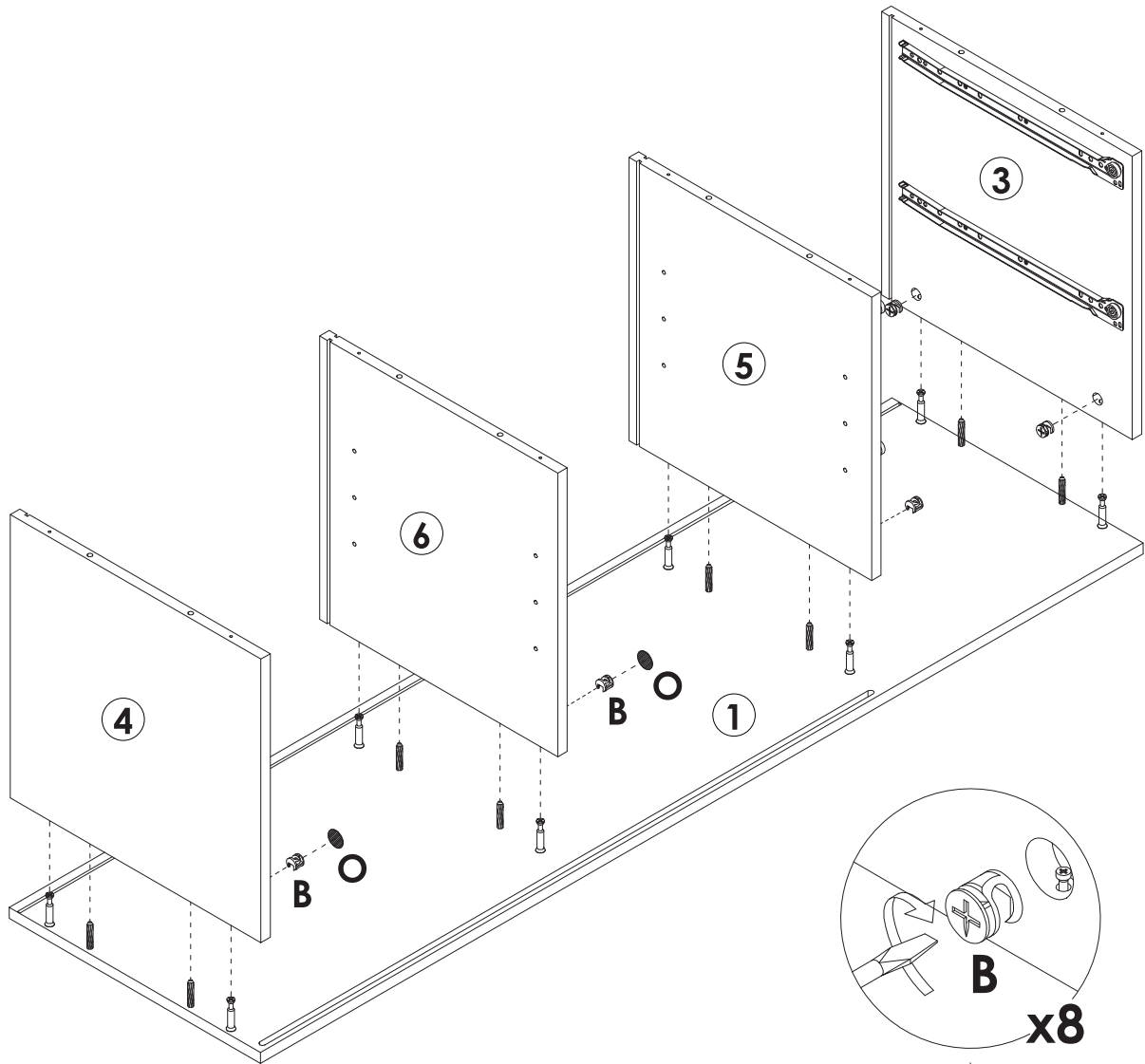
STEP 2



	B x 8PCS
	O x 4PCS

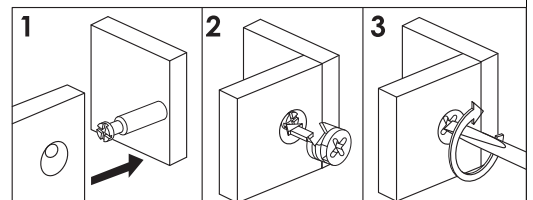

STEP 3

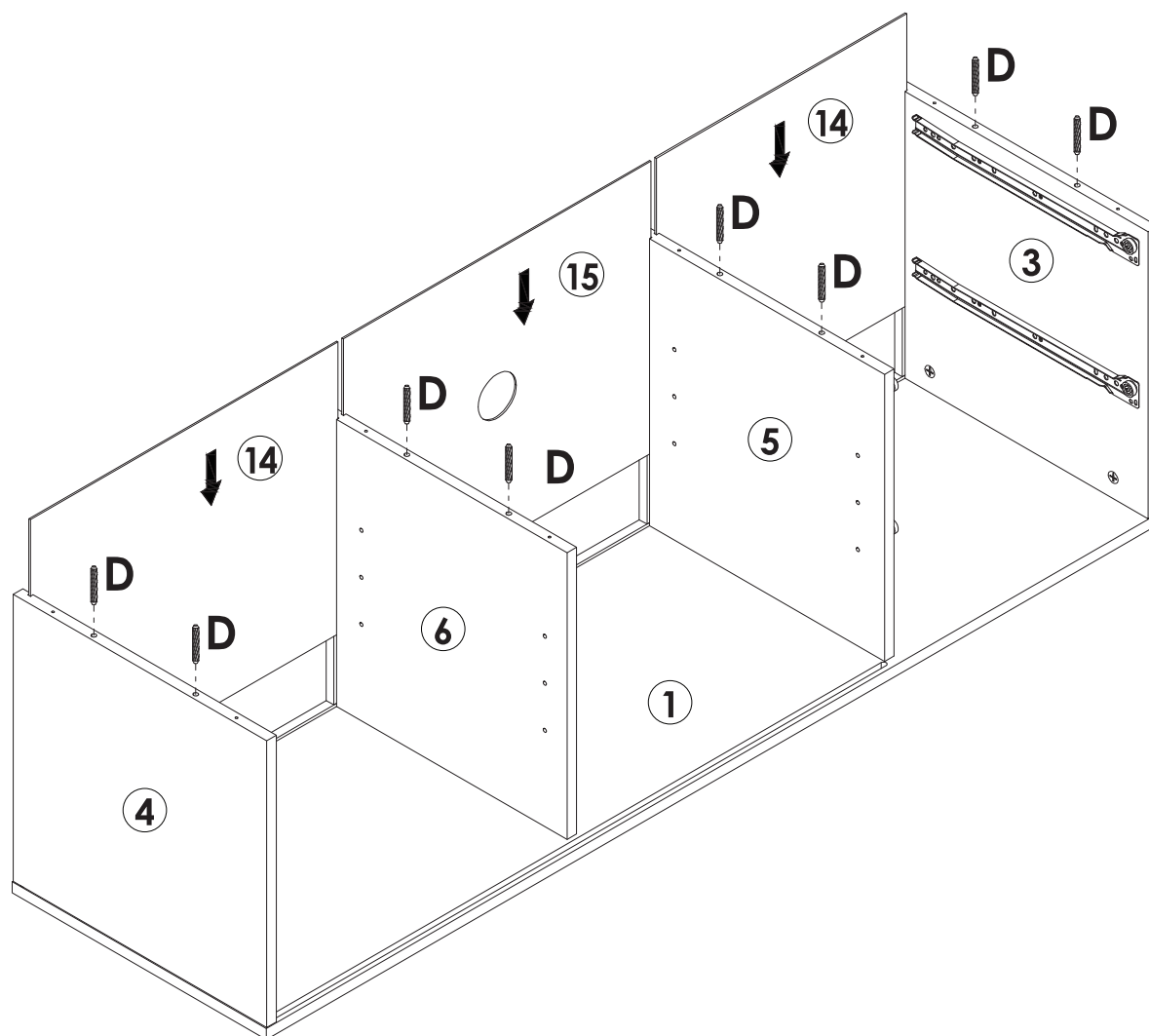

D x 8PCS

STEP 4

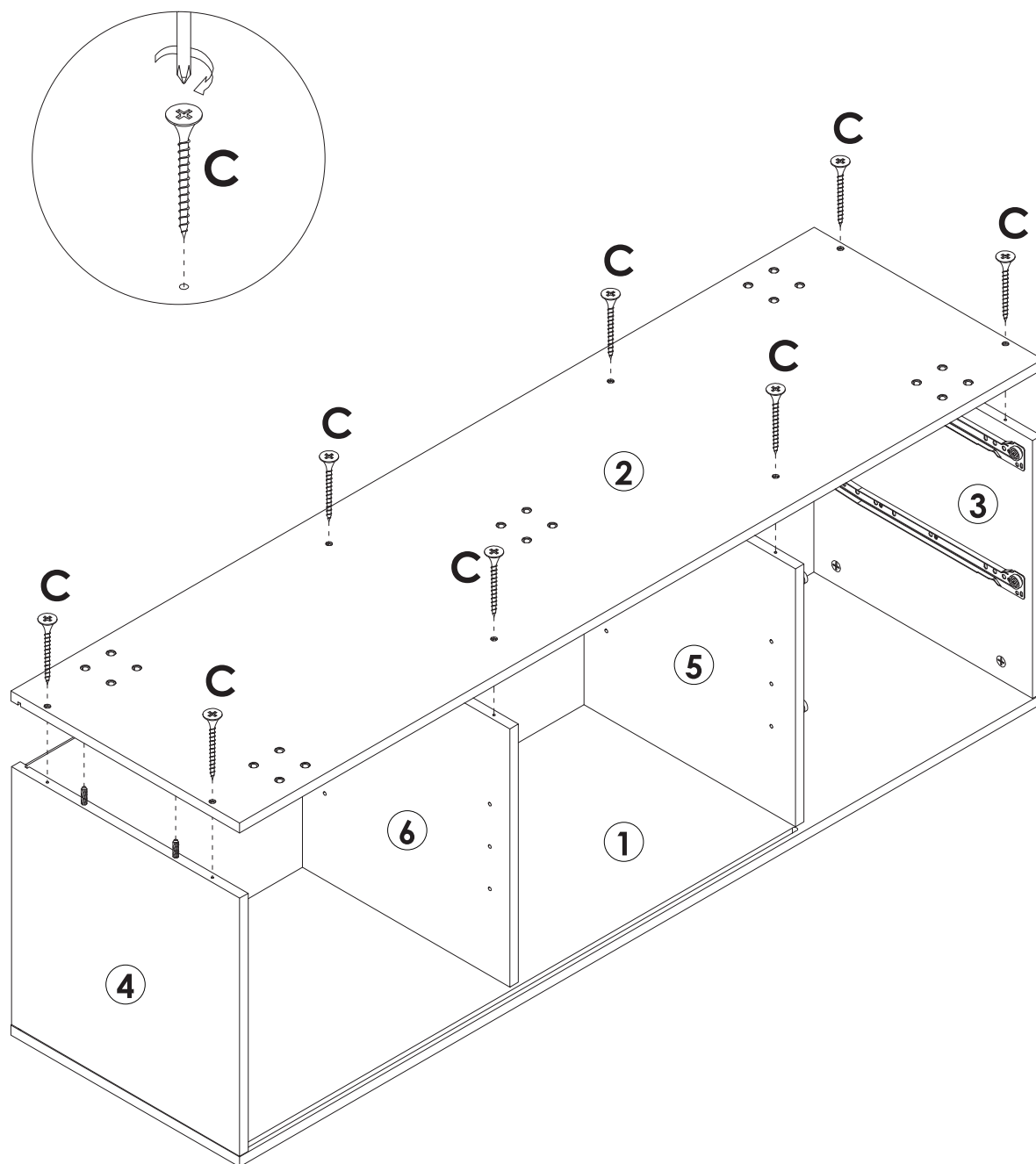



 C x 8PCS

Assembly Steps(EN) / Montageschritte(DE)

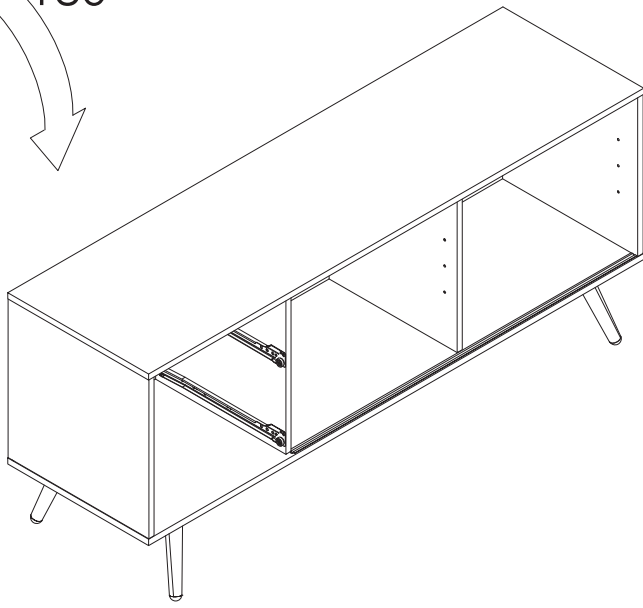
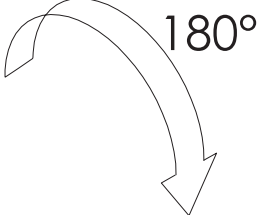
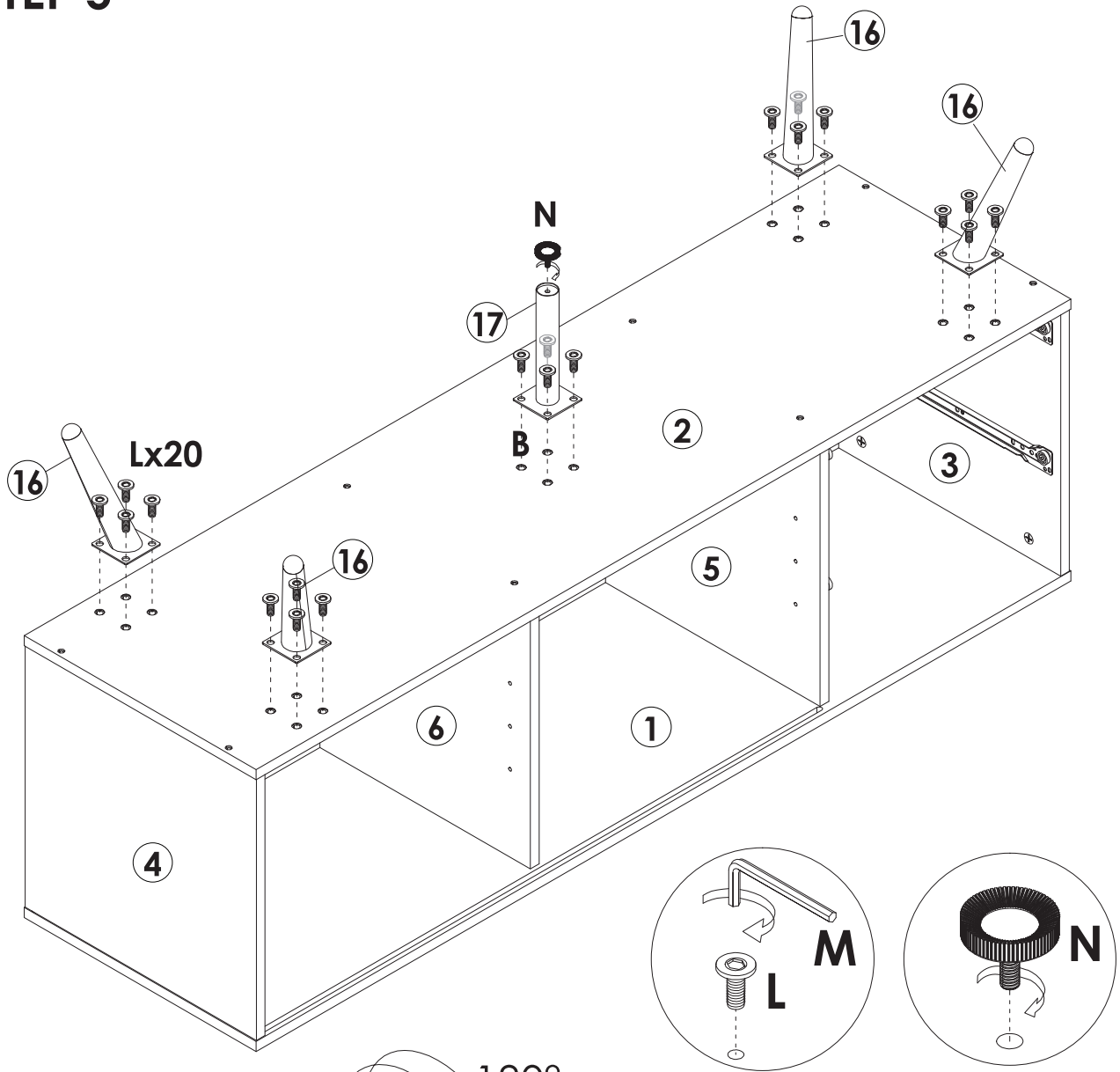
STEP 5





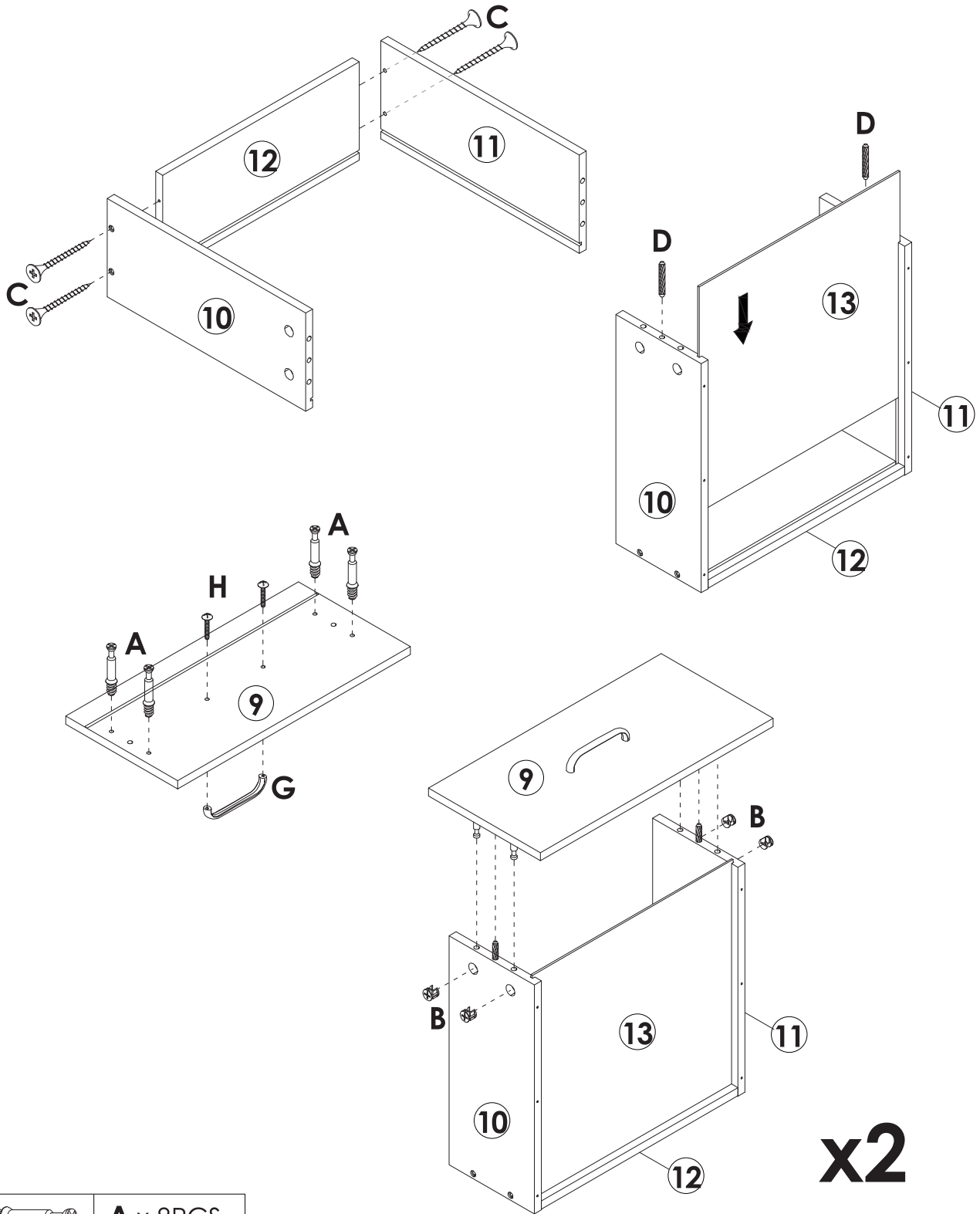

	L x 20PCS
	M x 1PC
	N x 1PC

Assembly Steps(EN) / Montageschritte(DE)

STEP 6

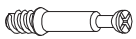

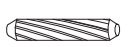
x2

	A x 8PCS
	B x 8PCS
	D x 4PCS
	G x 2PCS
	H x 4PCS

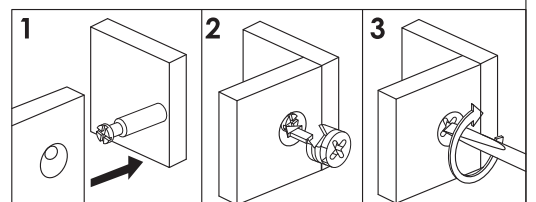

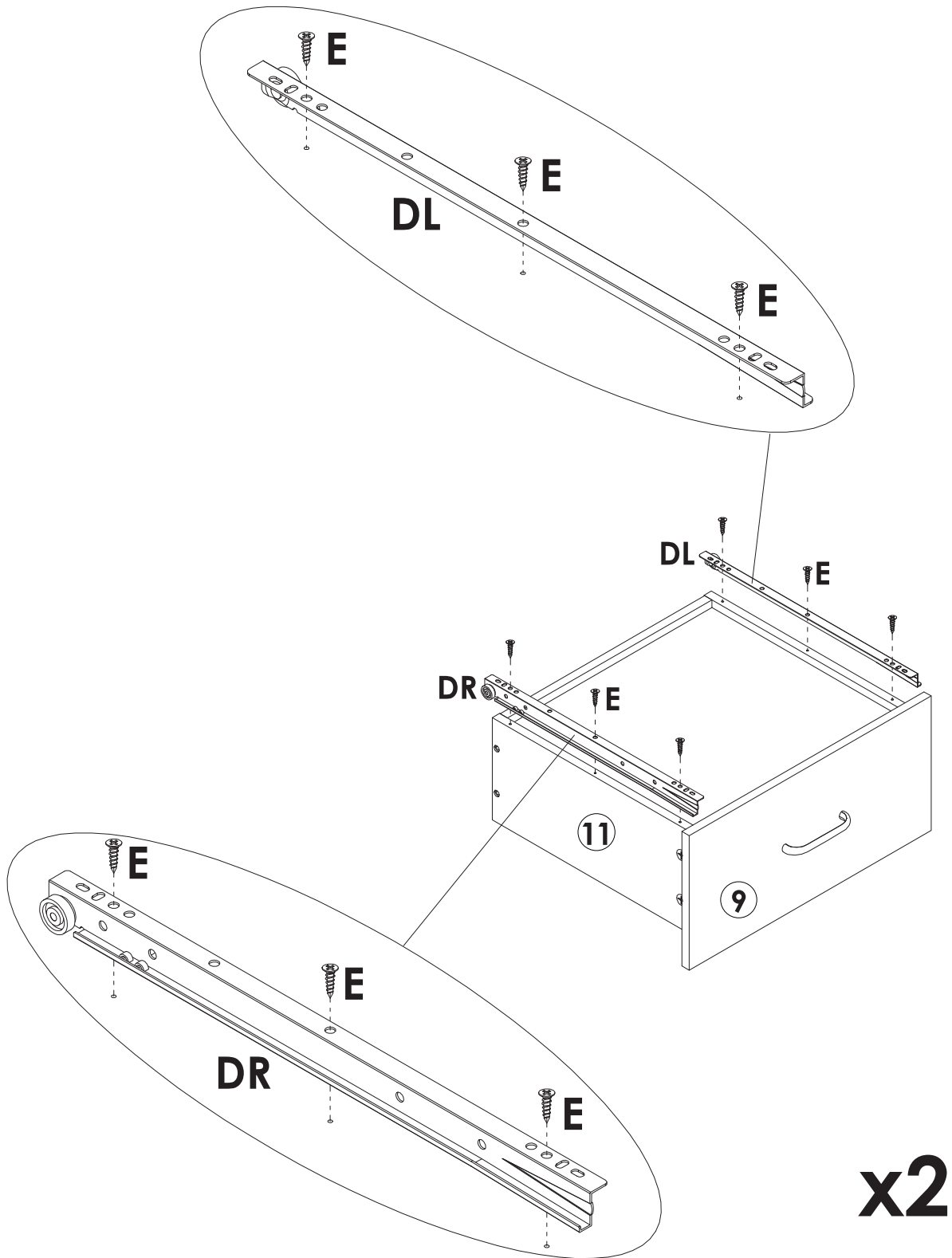

Assembly Steps(EN) / Montageschritte(DE)

STEP 7



x2

	E x 12PCS
	DL x 2PCS
	DR x 2PCS

Assembly Steps(EN) / Montageschritte(DE)

STEP 8

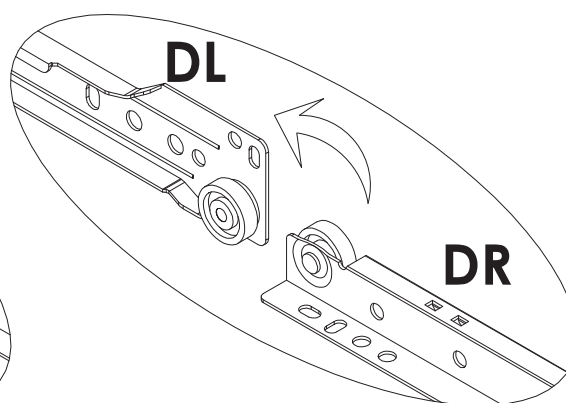
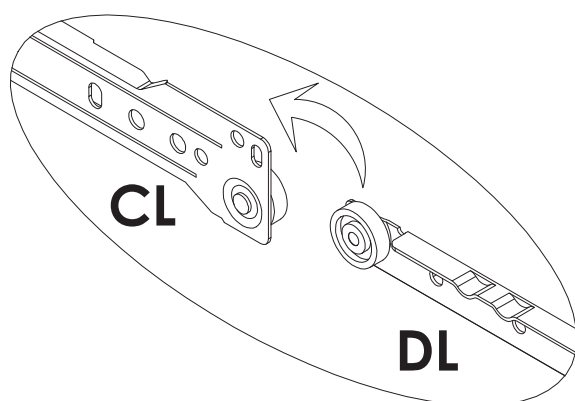
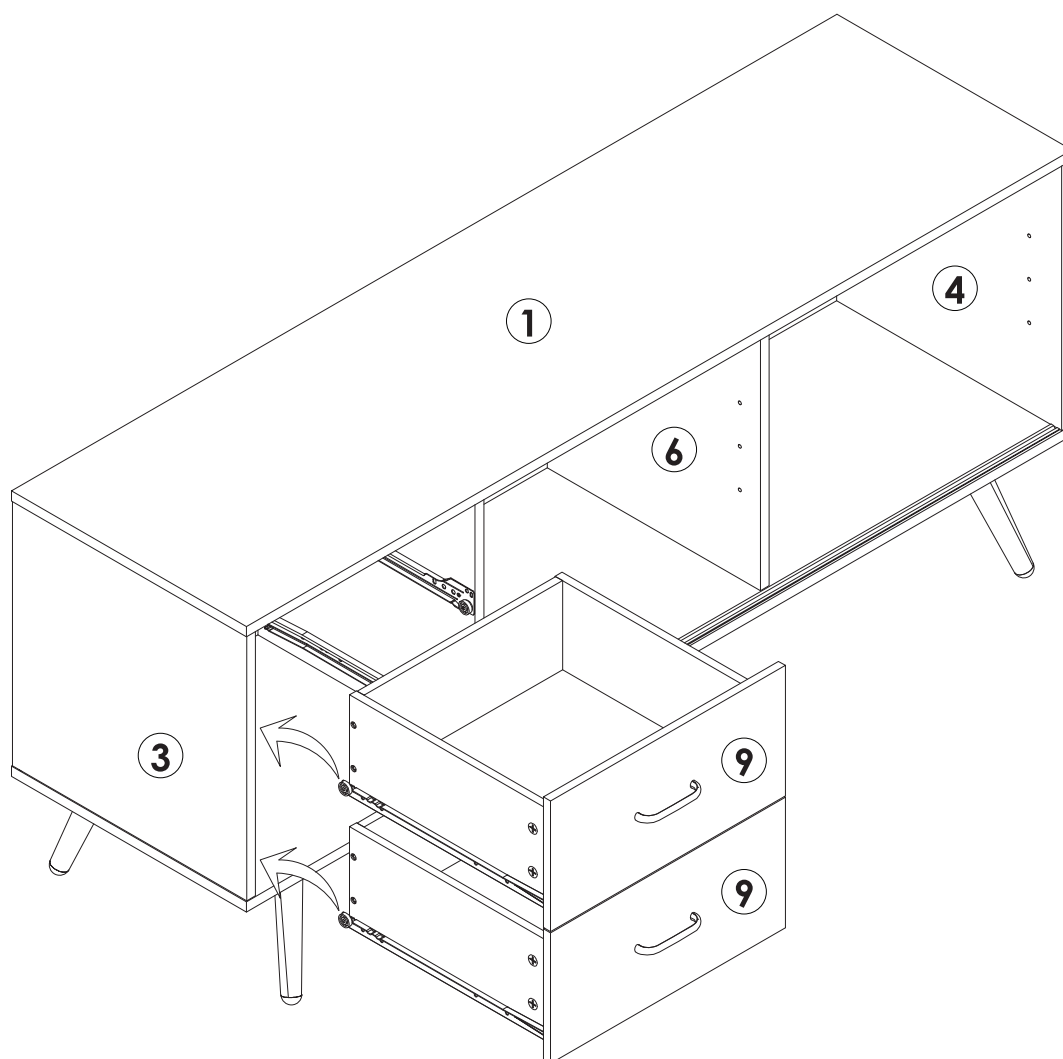

STEP 9

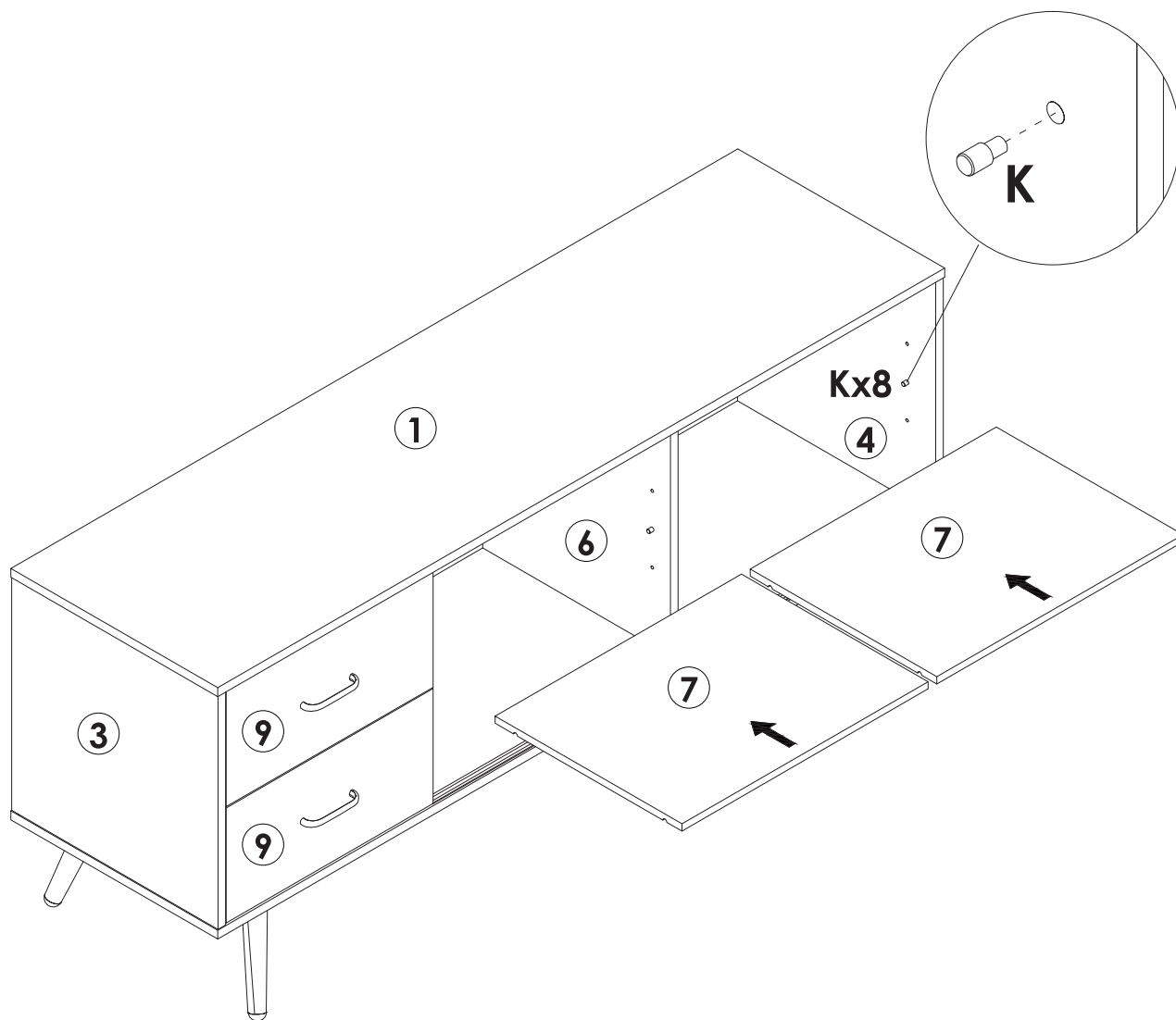



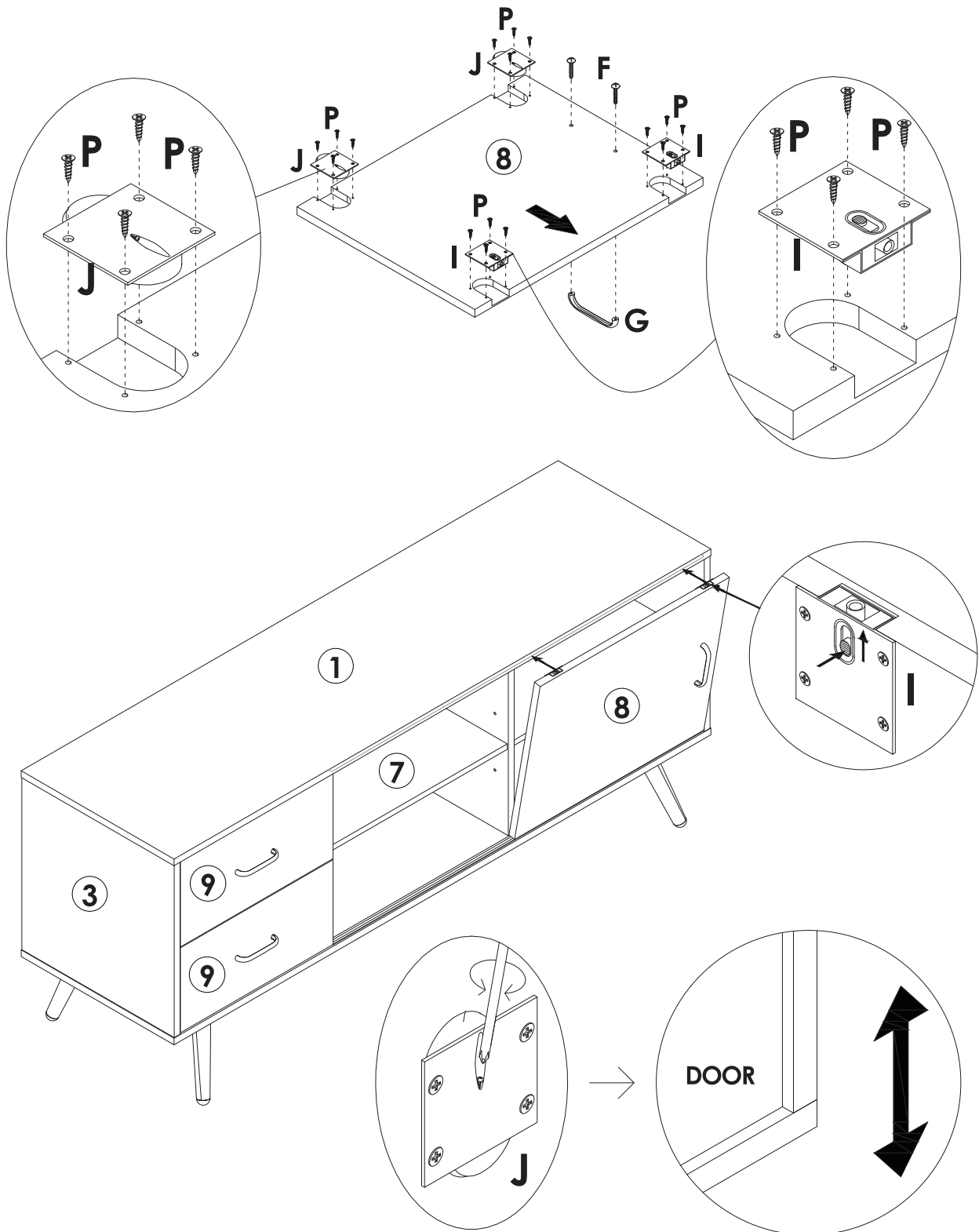

K x 8PCS

Assembly Steps(EN) / Montageschritte(DE)

STEP 10





	F x 2PCS
	G x 1PC
	I x 2PCS
	J x 2PCS
	P x 16PCS

Note: Dear customer, if the door sliding is too tight, please adjust this screw to improve. The door will gradually get loose and smooth with usage.

Assembly Steps(EN) / Montageschritte(DE)

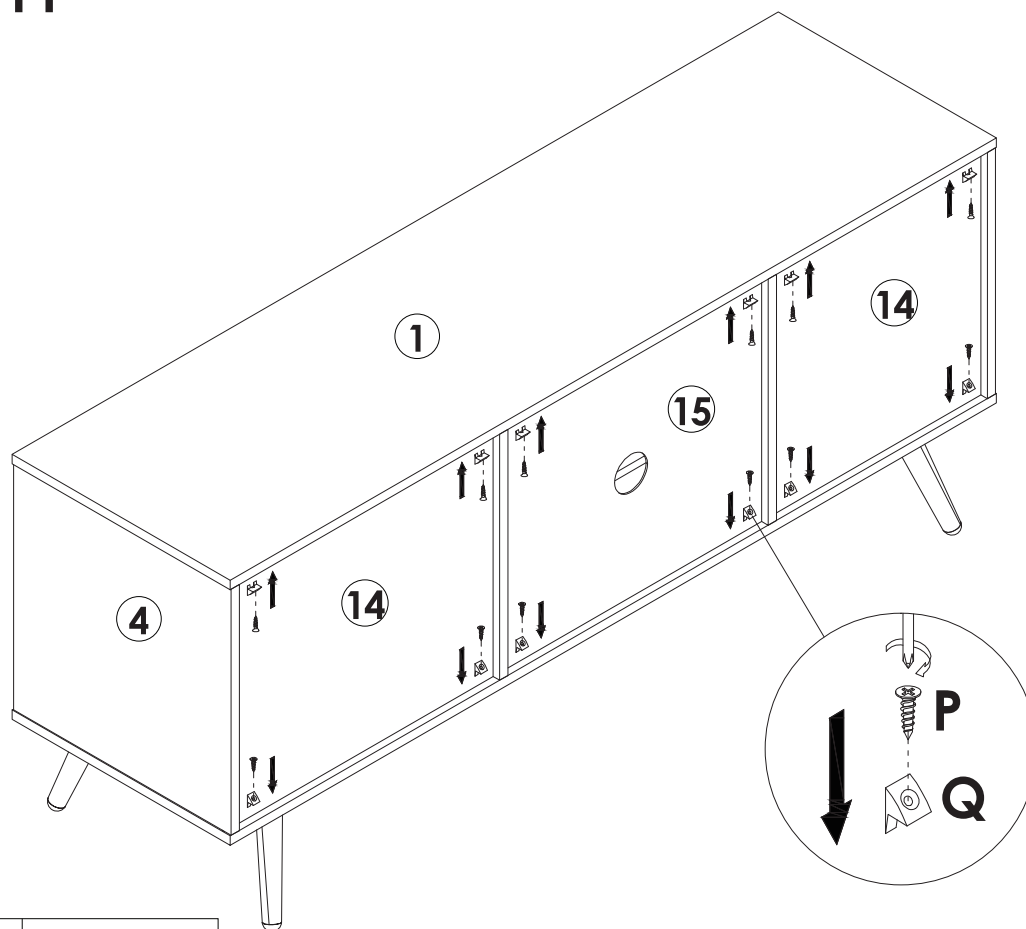
STEP 11



	P x 12PCS
	Q x 12PCS

STEP 12

