

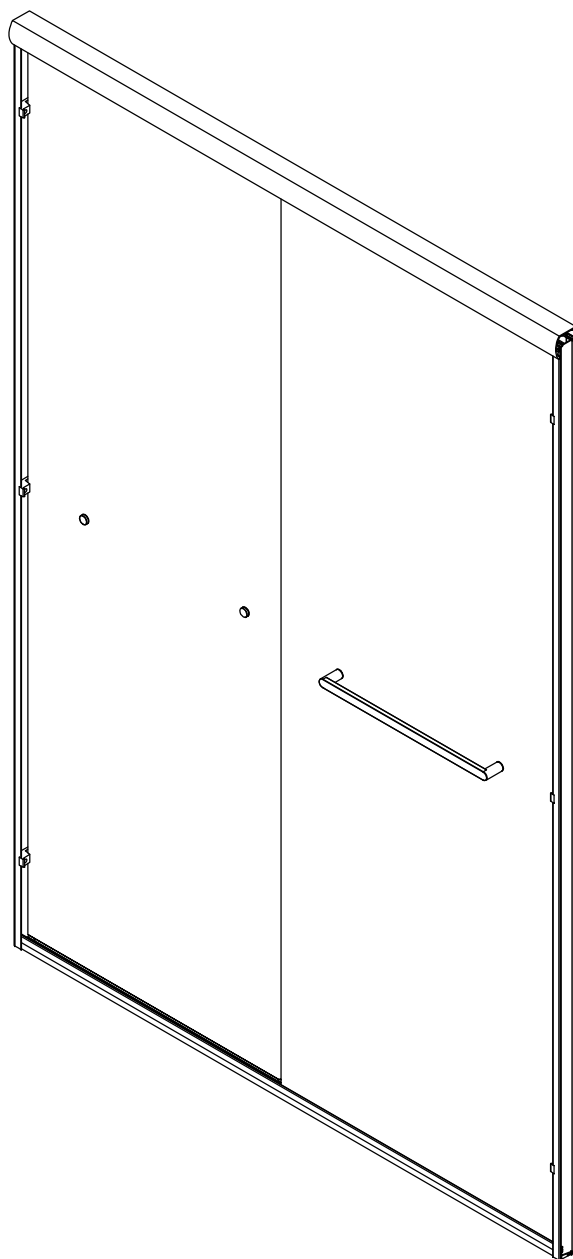

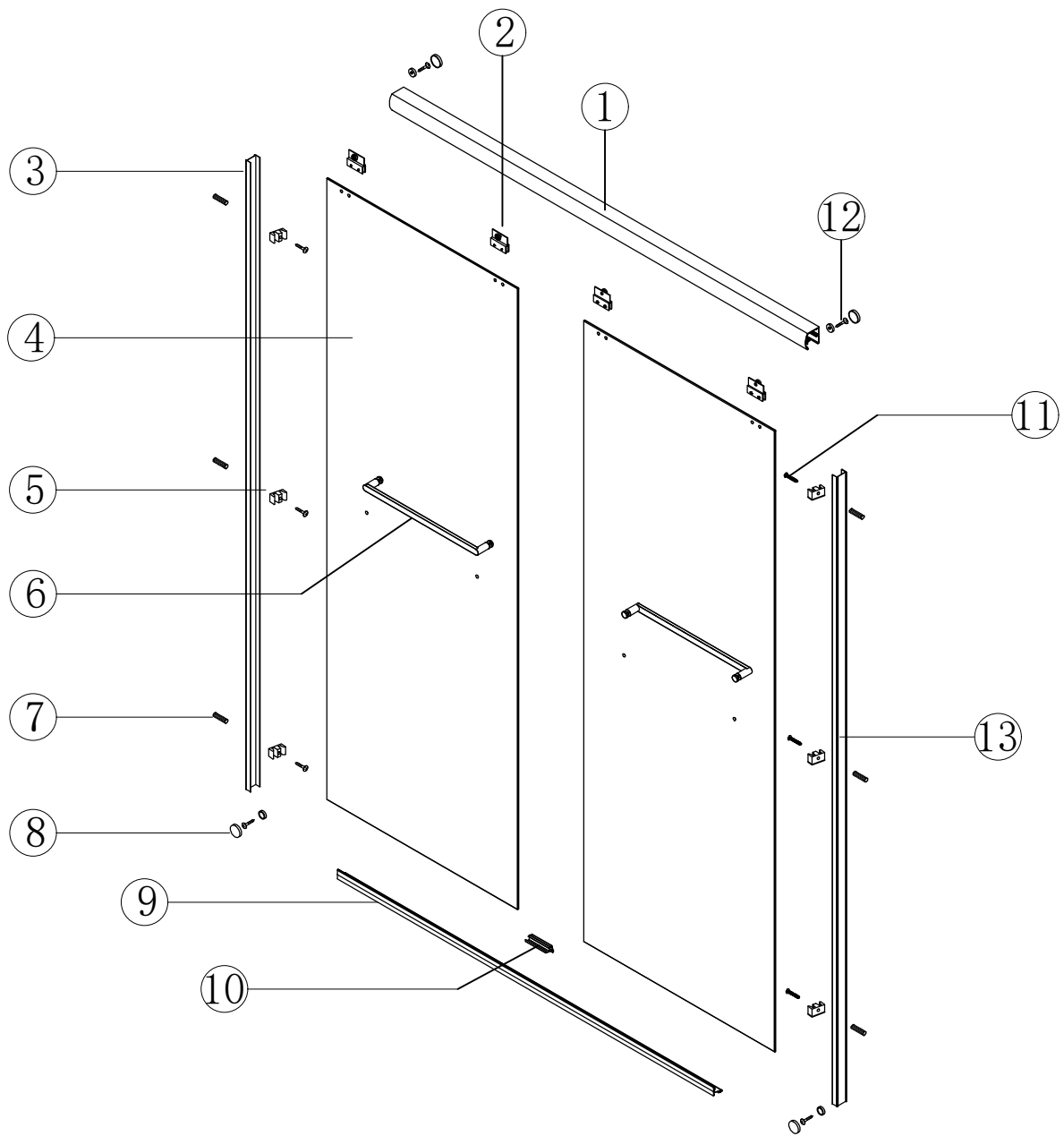









INSTALLATION MANUAL

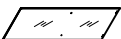

Cut to size according to demand.



NO.	NAME	PICTURE	Qty	NO.	NAME	PICTURE	Qty
1	Track		1	8	Decorative cover		4
2	Pulley		4	9	Lower Rail		1
3	left wall material		1	10	Lower slider		1
4	Movable glass		2	11	ST4*30		6
5	Buffer rubber strip		6	12	ST4*10		4
6	Handle		2	13	right wall material		1
7	Expansion tube		6				

TOOLS REQUIRED (NOT SUPPLIED)

When you're ready to start, make sure that you have the following tools to hand, plenty of space and a clean dry area for assembly.

Two people are needed.

Please note: although these instructions are comprehensive, we always recommend that a technically competent installer should undertake installation.

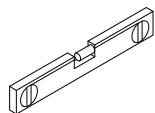

Spirit Level

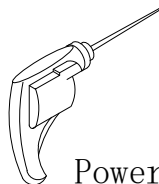

Power Drill



Ø6 Drill Bit



Silicone Sealant

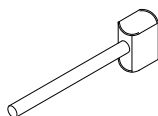

Rubber hammer



Tape measure

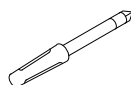

Screw driver

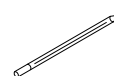

Pencil



Hanging Hammer

PRE INSTALLATION AND TECHNICAL REQUIREMENTS

All dimensions are shown in millimeters, except where otherwise indicated.

Ensure that the enclosure set is fitted to a level floor and vertical wall surface.

Please note: the wall fixings included with this product are suitable for solid walls only.

Plasterboard or stud walls may require specialist fixings (not supplied).

IMPORTANT SAFETY NOTES

Please handle all glass with care, avoiding knocks or shock loading to all sides and edges.

Safety glass cannot be reworked.

Please take care when drilling into walls to avoid hidden pipes or electrical cables.

AFTERCARE INSTRUCTIONS

Soap and water will be adequate to clean the glass a glass cleaner can be used if required.

In hard water districts, insoluble lime salts may be deposited on the glass. If this deposit is allowed to build up it becomes increasingly difficult to remove and looks unsightly. Regular cleaning will minimise this effect.

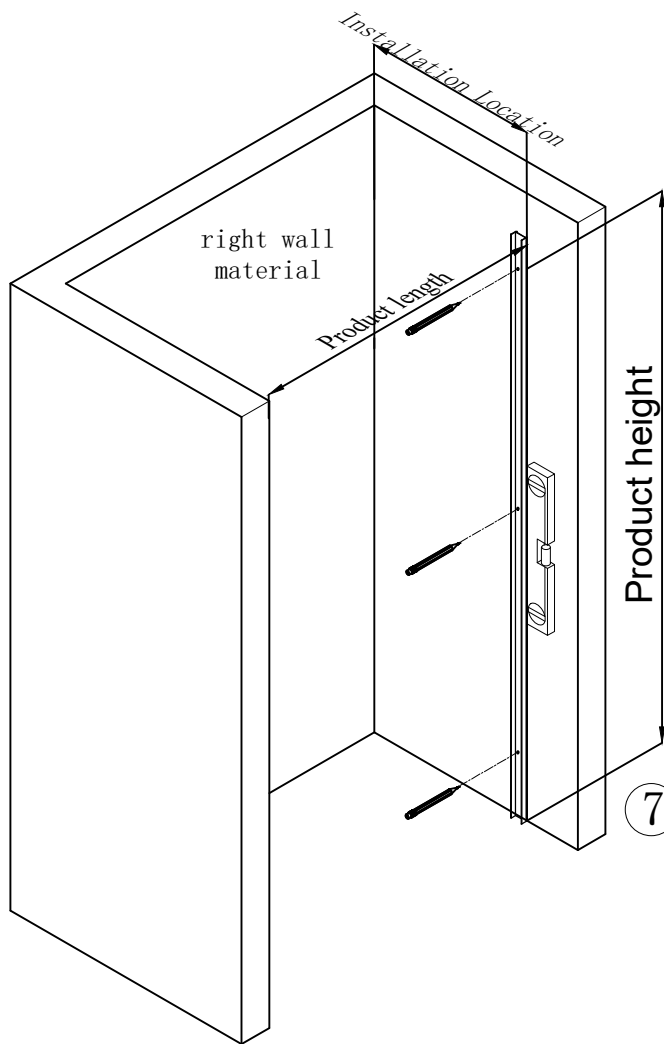

∅6 Drill Bit

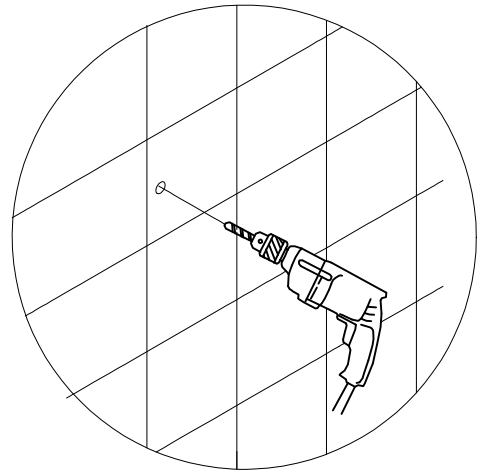

⑦ Expansion tube

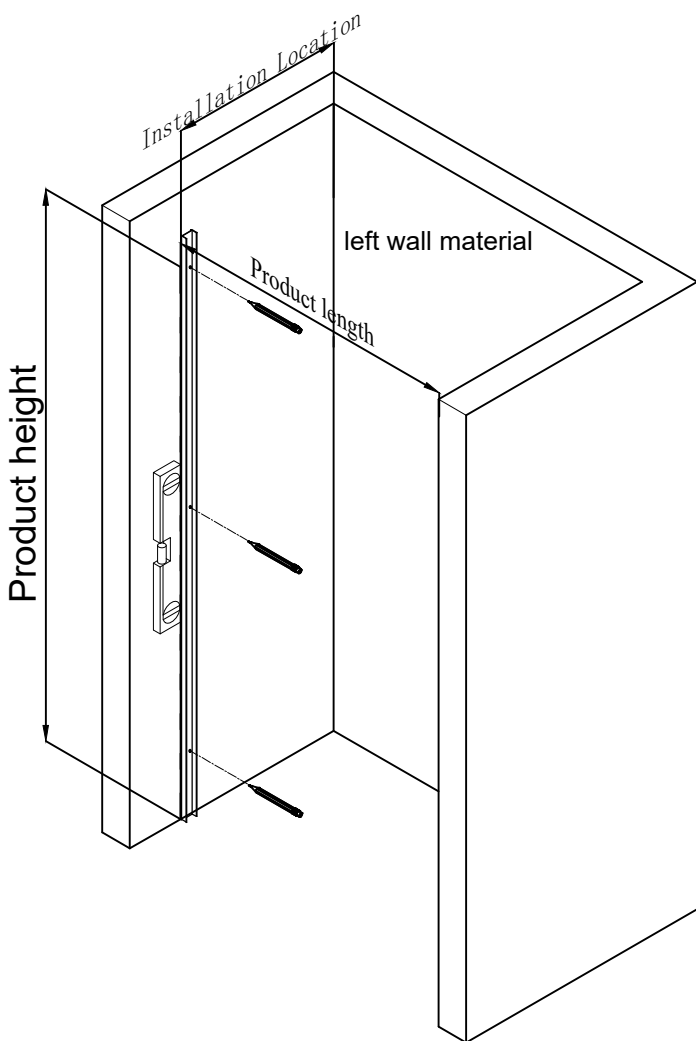
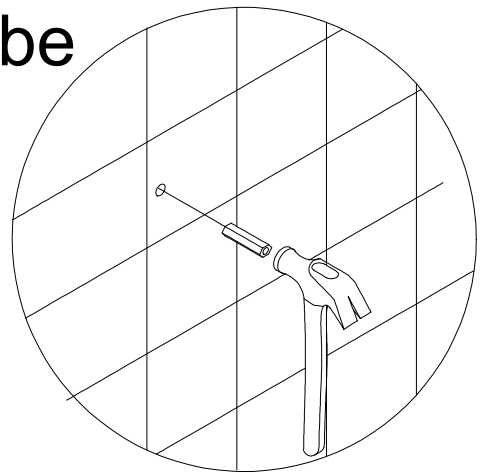

⑪ ST4*30 

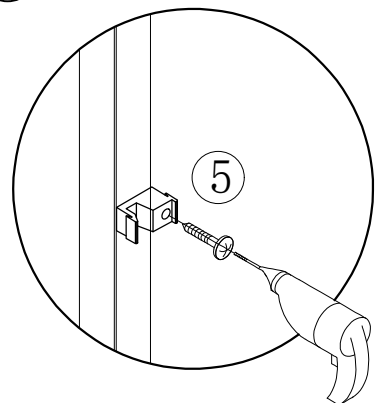

Pay attention to the direction of installing the top rail.

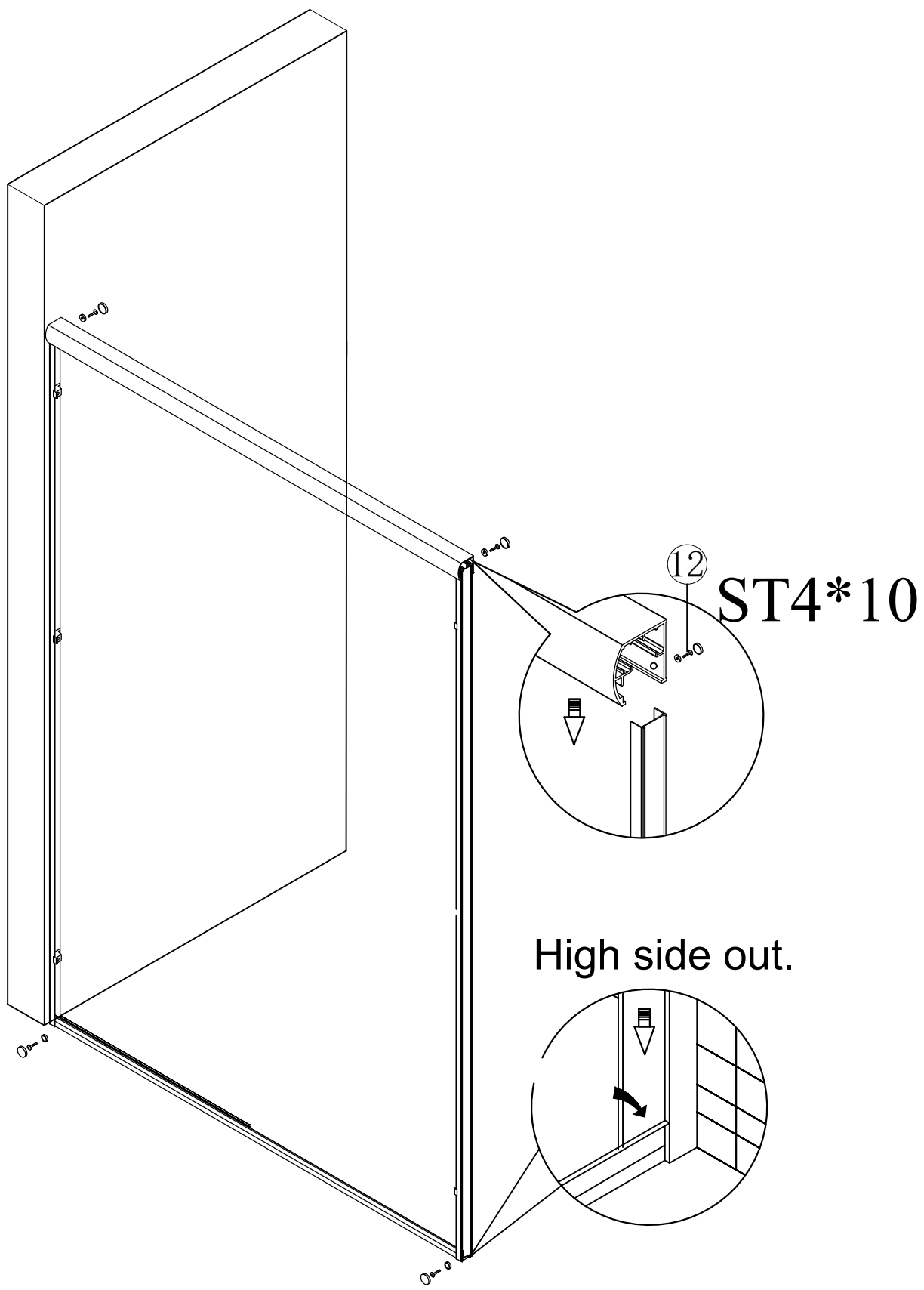

Pay attention to the direction of installing the lower track.

The pulley is installed on the glass.

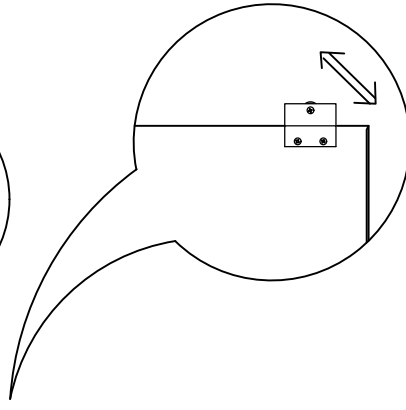
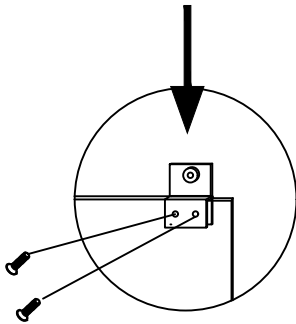
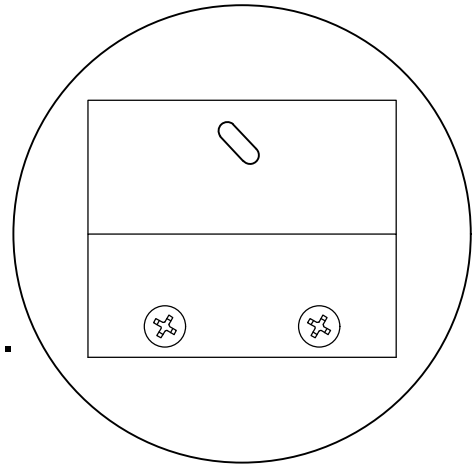

Adjust the height

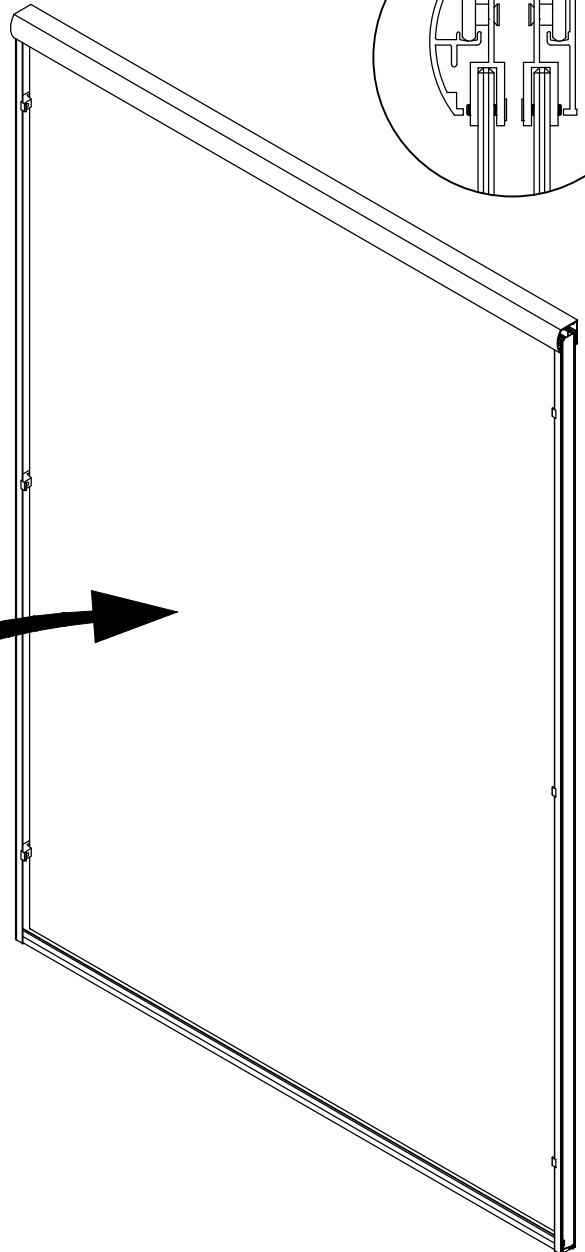
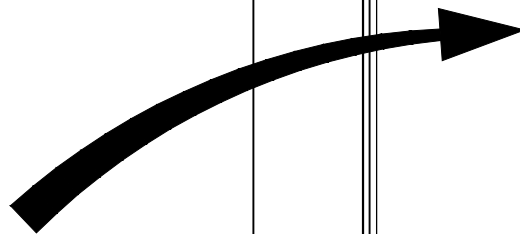
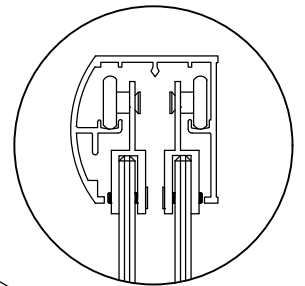
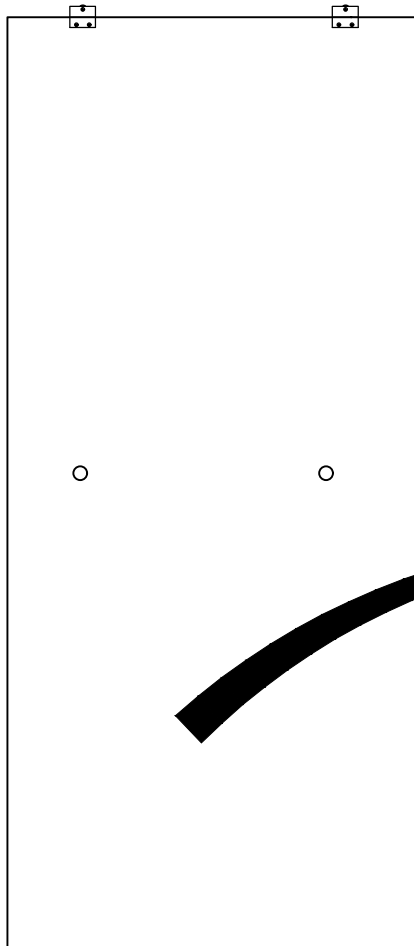

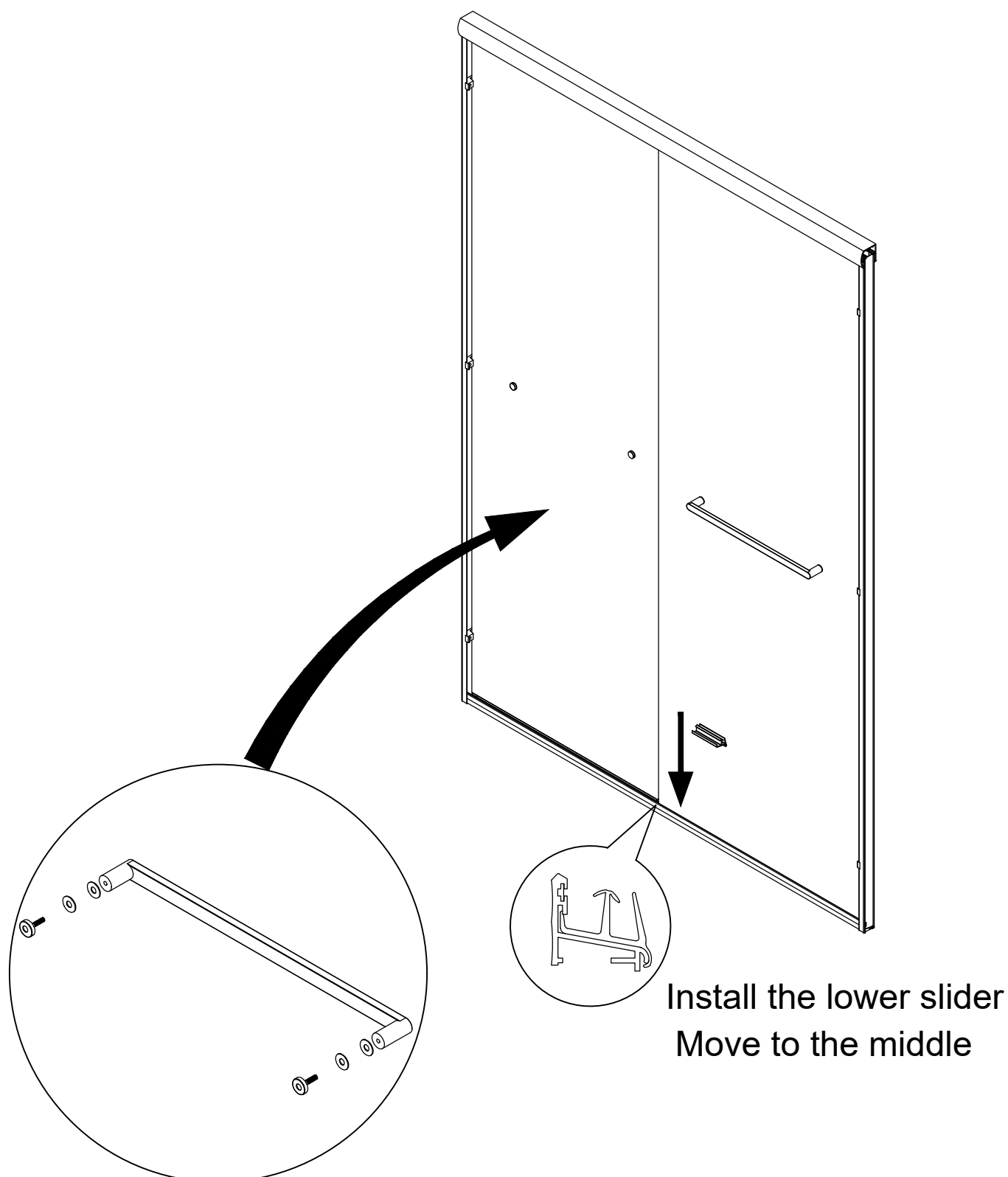

Install the lower slider
Move to the middle

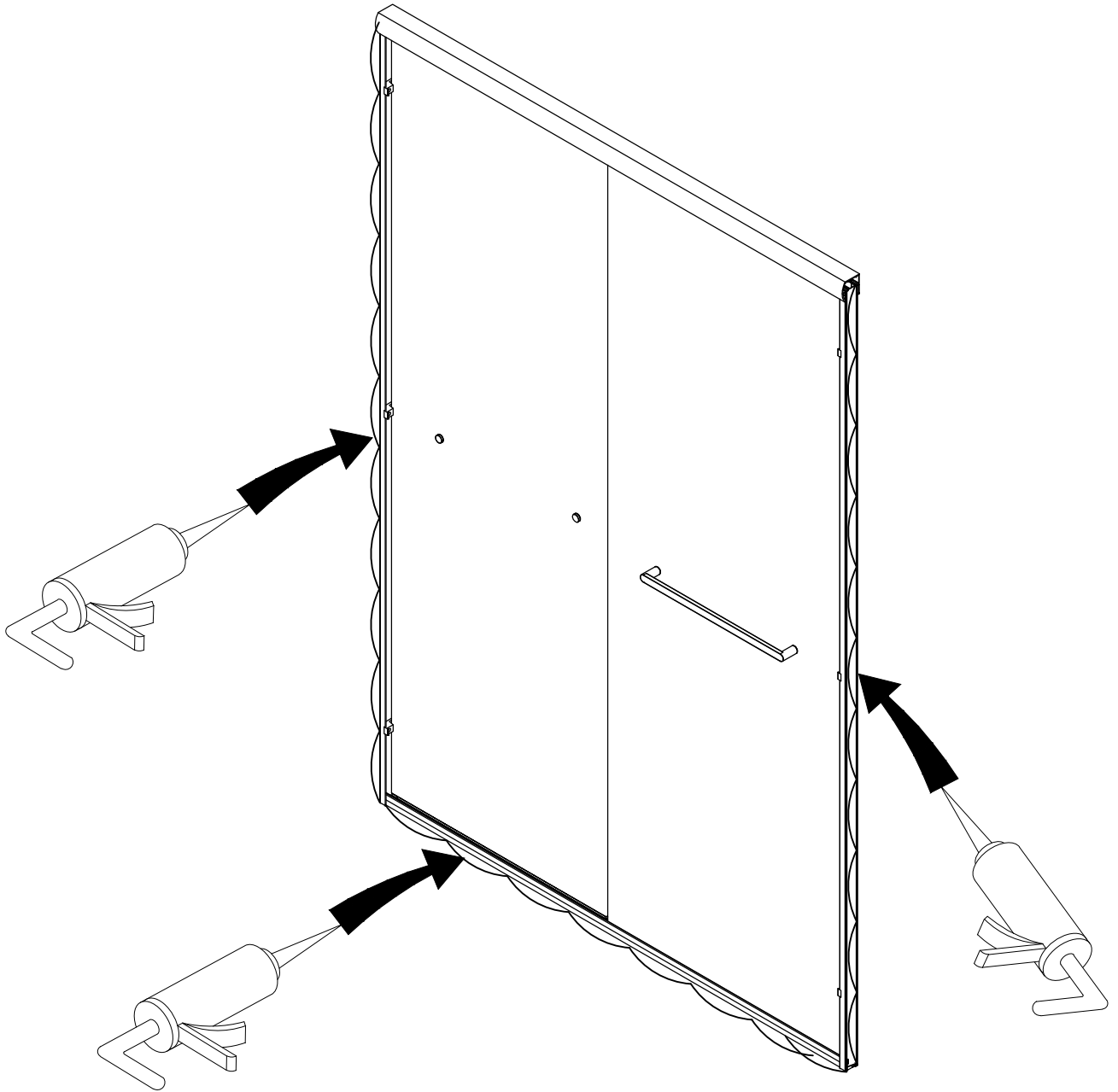

24 Hours

