

ASSEMBLY INSTRUCTIONS

MODEL #

CM3212AC-2PK

Questions?

GIVE US CALL: 1-888-980-5122
MON-FRI 8:30AM - 5:30PM (PST)

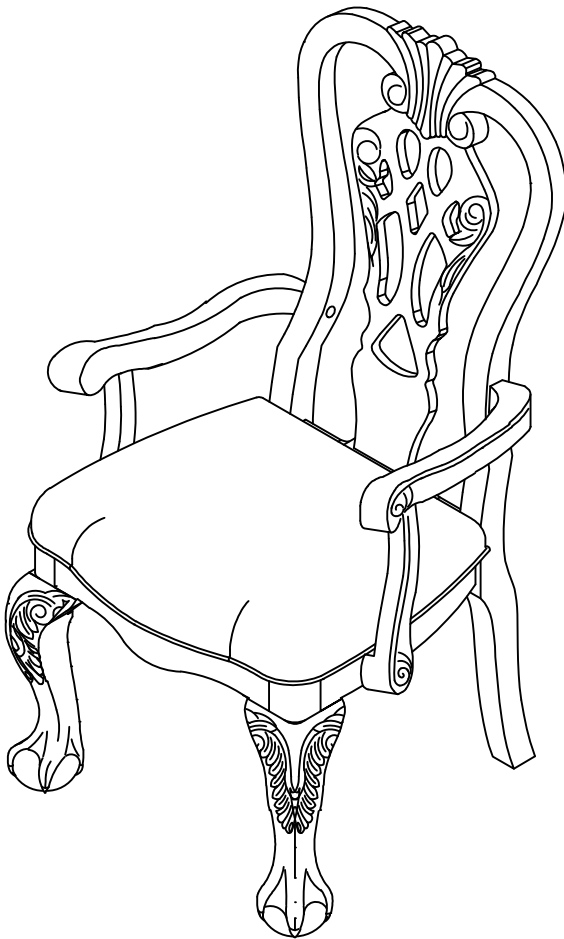

TOOLS REQUIRED



Allen Wrench

(Included)



Phillips
Screwdriver

(Not Included)



2 - People
Recommended

ASSEMBLY RATING

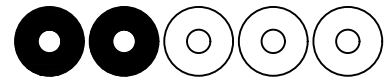

EASY —————> DIFFICULT

The Assembly Rating is a 5-point system showing the level of effort needed to assemble a specific product.

PRE ASSEMBLY INTRODUCTION

We understand building ready-to-assemble furniture can be a challenging experience for some. To help avoid confusion, we have provided some helpful tips that may speed up the process.

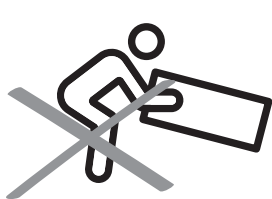

Teamwork

ALWAYS have at least two people to help with transporting and assembling the product to avoid potential injury and/or damage.

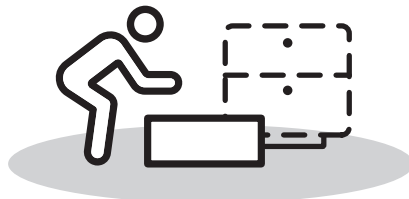
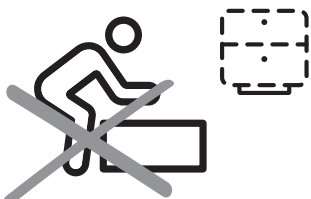

Suitable Location

Assembling near the area of the intended location is highly recommended.



Sufficient Space

Make sure you have enough space to move around during the assembly.

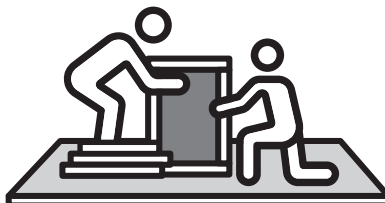

Avoid Scratches

Use cardboard, blankets or a carpeted area while assembling furniture to prevent scratches.

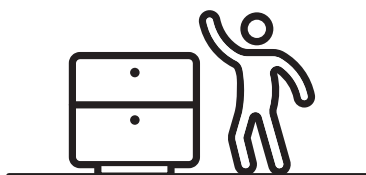
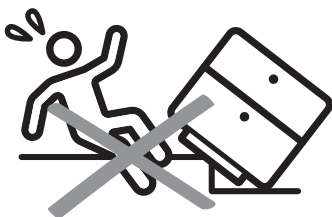

Flat Surface

Make sure the furniture rests on a flat and level surface with each leg evenly touching the floor.

ASSEMBLY AND CARE ADVICE



FAILURE TO FOLLOW THE GUIDELINES BELOW MAY RESULT IN INJURY AND/OR PROPERTY DAMAGE.



Position each part correctly and insert screws or bolts into their respective holes.

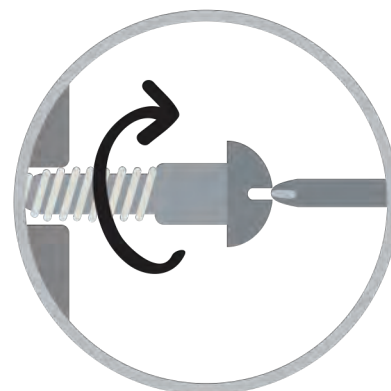

Turn clockwise to tighten and only tighten when step is completed or when instructed to do so.



Use the appropriate hand tools or power tools for assembly. Select steps, such as tightening screws and/or bolts, may require hand tools to avoid causing damage during assembly.



Save the instructions and store any supplied tools for later maintenance.

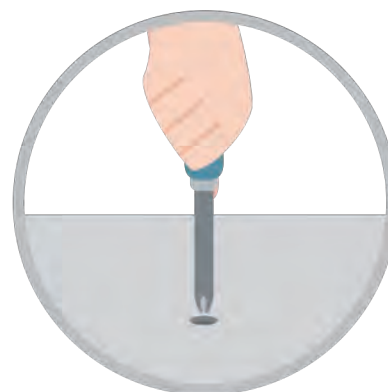

After two weeks, check and tighten any loose hardware and repeat again every six months thereafter.

IT IS THE USER'S RESPONSIBILITY TO MAINTAIN THE FURNITURE. THE HARDWARE MAY LOOSEN OVER TIME AND MAY CAUSE THE FURNITURE TO BE WOBBLY AND UNABLE TO SUPPORT ITS INTENDED WEIGHT CAPACITY. THIS MAY LEAD TO COLLAPSE AND MAY CAUSE SERIOUS INJURY.

CHAIR

CM3212AC-2PK



- Please keep instructions for future reference.
- Check the quantity and irregularity of parts and hardware before you start.

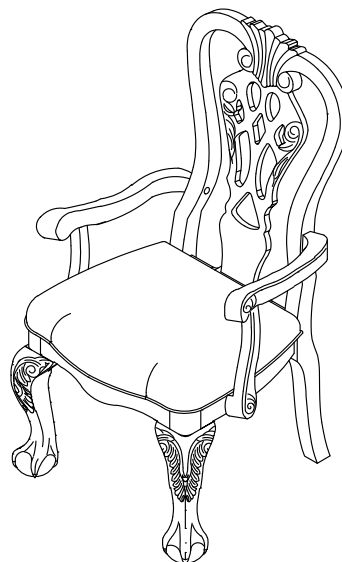

PARTS

#1 1pc x2



Chair Back

#2 1pc x2



Cushion Seat

#3 2pcs x2



Front Leg

#4 2pcs x2



Arm L&R

HARDWARE

#A 5pcs x2



Bolt Ø5/16" x 1-1/2"

#B 4pcs x2



Bolt Ø5/16" x 2-3/8"

#C 4pcs x2



Bolt Ø5/16" x 2-3/4"

#D 13pcs x2



Lock Washer Ø5/16"

#E 11pcs x2



Flat Washer Ø5/16"

#F 1pc x2

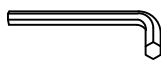

Allen Wrench M4

#G 2pcs x2



Wood Nut Ø15x9

Exploded View

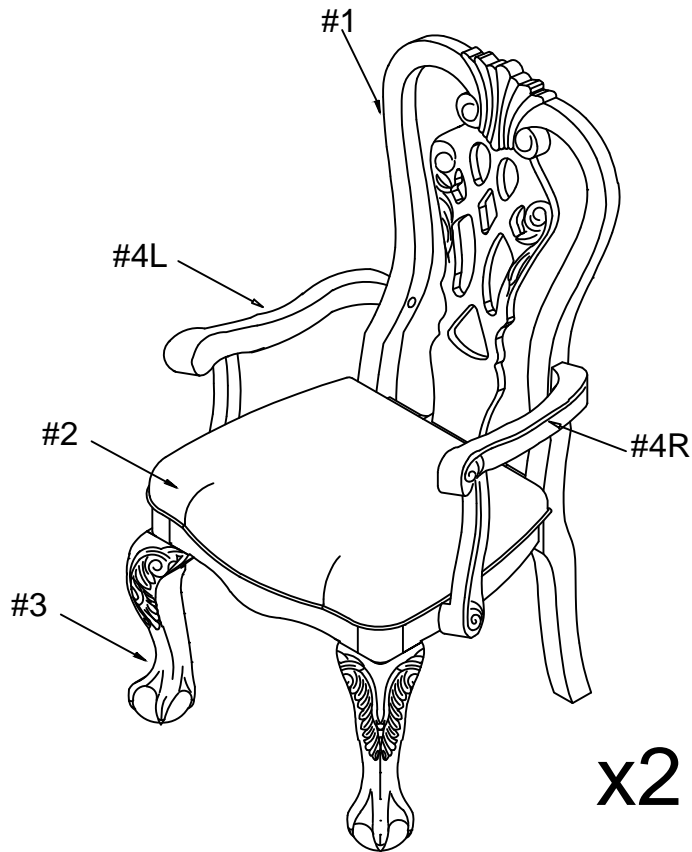

ASSEMBLY INSTRUCTIONS

1

- Part (#1) x1pc
- Part (#2) x1pc
- Hardware (#A) x1pc
- Hardware (#D) x1pc
- Hardware (#E) x1pc

1. Place the backrest w/legs (#1) onto a protected surface.

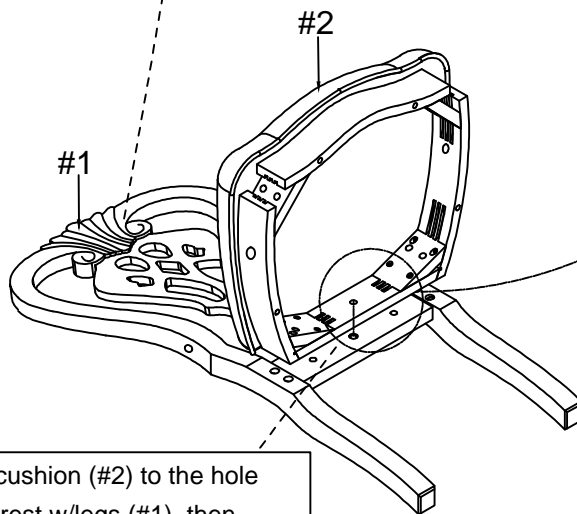

3. Align the seat cushion (#2) to the hole along the backrest w/legs (#1), then insert the bolt assembly into the center hole and secure using the Allen wrench.

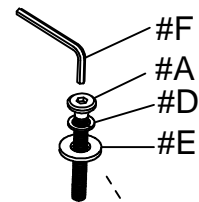

2. Prepare a bolt assembly by inserting a lock washer (#D) onto the bolt (#A) then a flat washer (#E) onto that same bolt (#A).

x2

ASSEMBLY INSTRUCTIONS

2

Hardware #C x4pcs

Hardware #D x4pcs

Hardware #E x4pcs

Prepare 4 bolt assemblies by inserting a lock washer (#D) onto the bolt (#C) then a flat washer (#E) onto that same bolt (#C). Insert 2 bolts into each back corner and secure using the Allen wrench (#F).

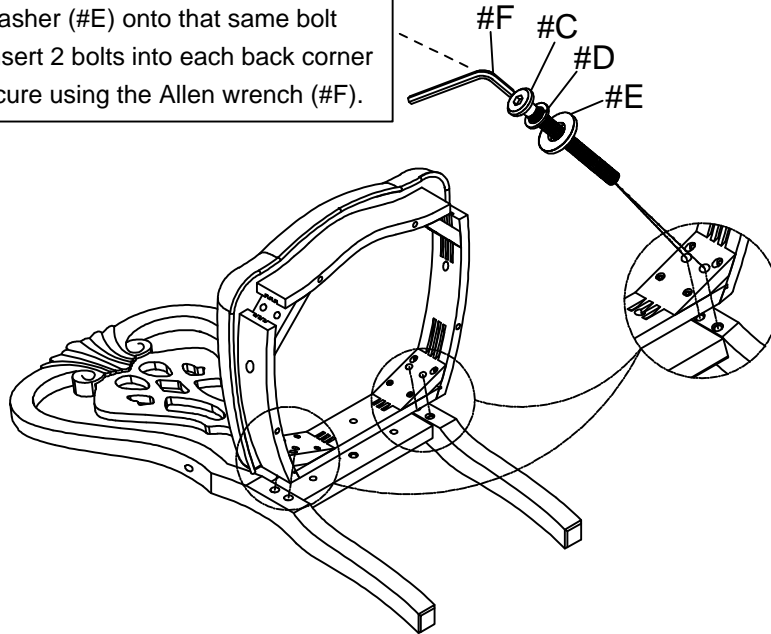

x2

3

Part #3 x2pcs

Hardware #B x4pcs

Hardware #D x4pcs

Hardware #E x4pcs

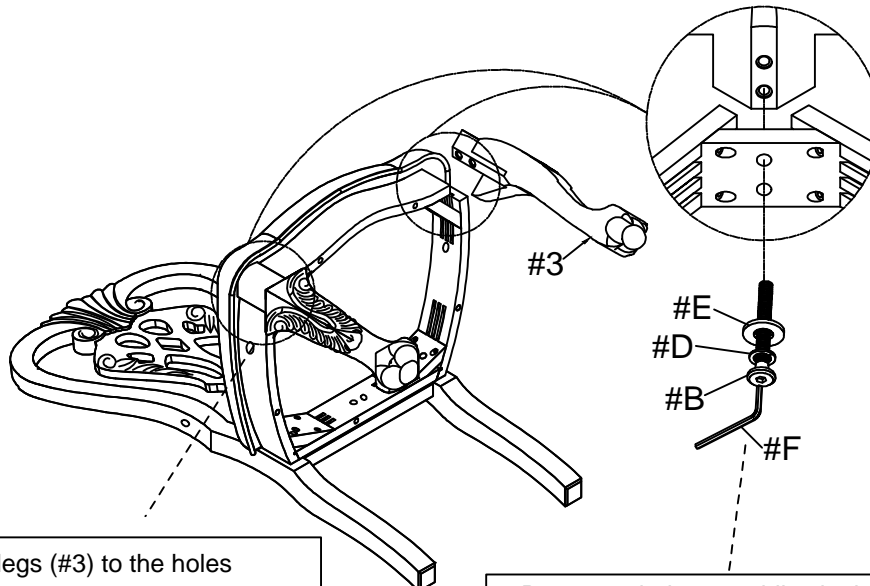

x2

2. Align the front legs (#3) to the holes along the front corners of the seat (#2), then insert 2 bolt assemblies into each corner and secure using the Allen wrench.

1. Prepare 4 bolt assemblies by inserting a lock washer (#D) onto the bolt (#B) then a flat washer (#E) onto that same bolt (#B).

ASSEMBLY INSTRUCTIONS

4

Part #4 x2pcs

Hardware #A x4pcs

Hardware #D x4pcs

Hardware #E x2pcs

Hardware #G x2pcs

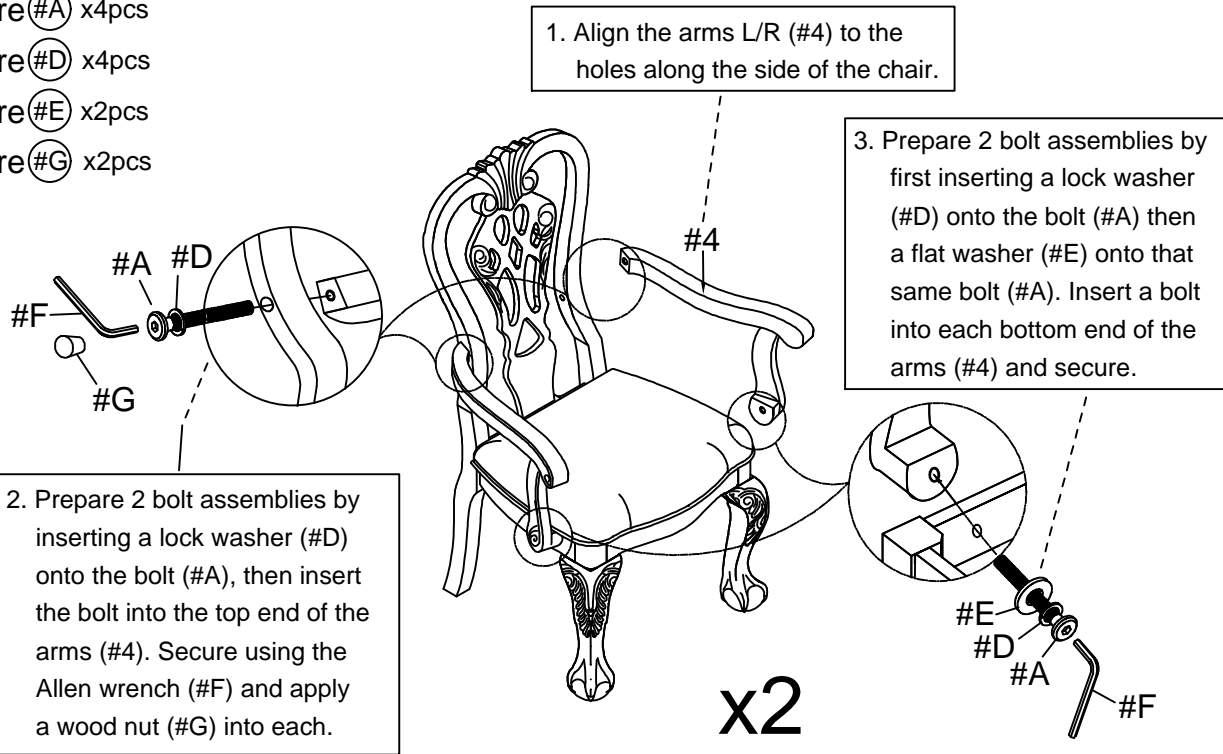

5

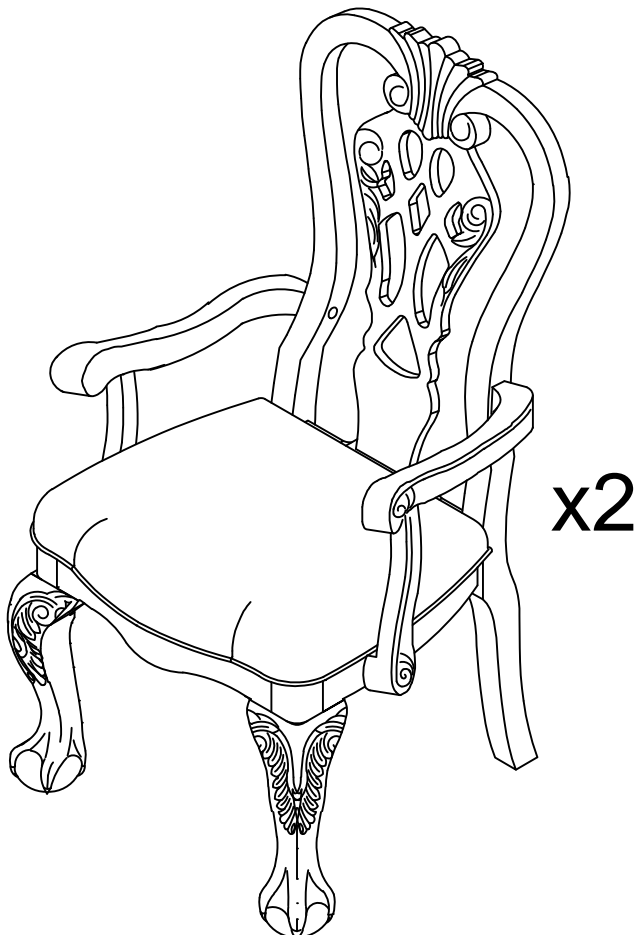

ASSEMBLY COMPLETED



Please ensure the furniture rests on an even and flat surface. If the product wobbles or feels loose, double-check all bolts and/or screws are properly tightened and secured.



Keep this handy!

Please retain this instruction manual and any order-related information for future reference.



Lift, don't drag!

To avoid damage to product please always LIFT the product when transporting or adjusting the placement.