

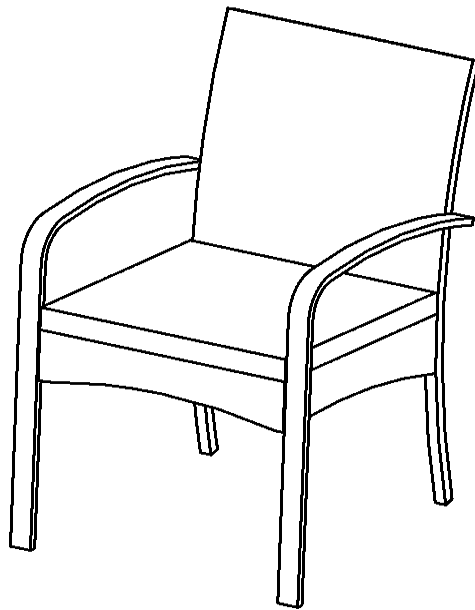



Assembly Instructions

Caution : You must read this before you proceed

Chair

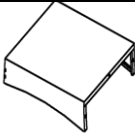

Parts List

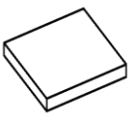
Label	Picture	Description	QTY
A		Backrest	1
B		Seat	1
C		Right Armrest / Leg	1
D		Left Armrest / Leg	1
E		Seat Cushion	1

Hardware

Label	Picture	Description	QTY
①		Bolt(M6*55MM)	3
②		Bolt(M6*35MM)	3
③		Bolt(M6*25MM)	9
④		Washer	15
⑤		Nut Cap	3
⑥		Allen Key	1

Assembly Preparation

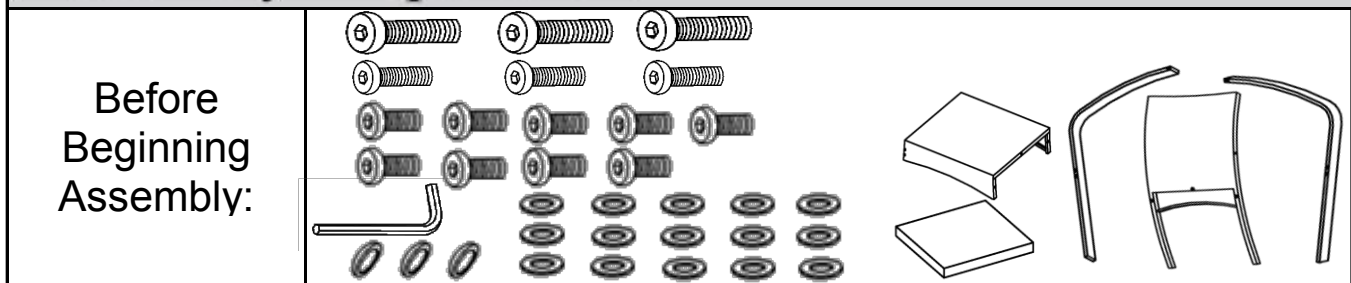

Before Beginning Assembly:

- Read instructions, cover to cover-
- Have 2 adults on hand for assembly-
- Do not assemble on flooring or carpet-
- Assemble on a clean non-marring surface (packing foam)-
- Save all packaging until finished-

Assembly Steps

Overview

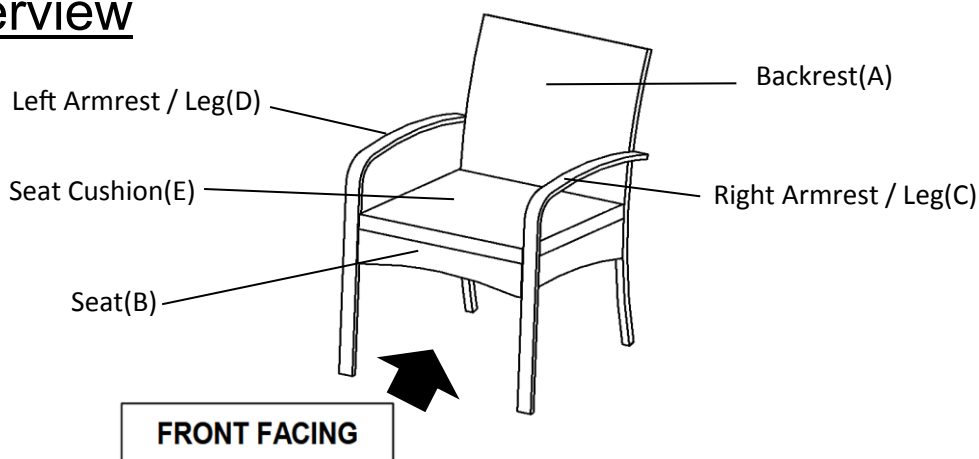

This Chair has multiple parts and may require up to some 30 minutes to assemble. To give you an overview of the Chair parts, the above picture is to help you put the various parts into perspective. Please read through the instructions herebelow to familiarise yourself with the parts and steps before assembly.

Step 1

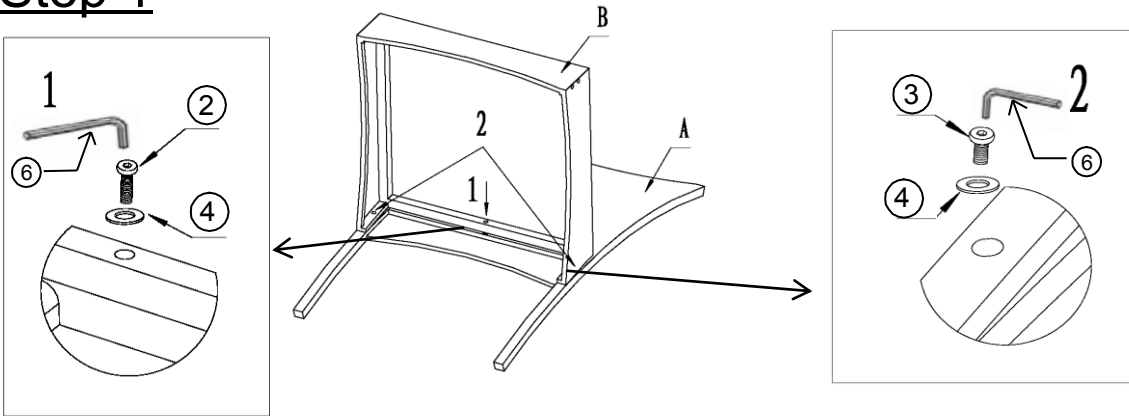

Open the carton and place all the parts onto a clean and soft surface.

Unpack all packages of hardware.

Place the Backrest (A) with its inside facing skywards.

Attach Seat(B) to Backrest(A) using Hardware(2) (3)(4) with Allen Key(6) as shown in Picture 1 and Picture 2.

Do not fully tighten the bolts.

ATTENTION: Occasionally some of the PE Wicker shifts and covers the mounting positions preventing easy assembly.

The PE wicker should never be cut, but moved away from the mounting positions.

Step 2

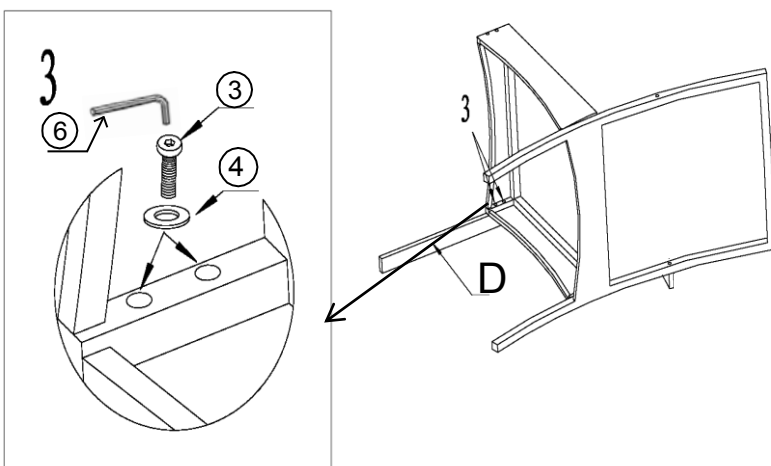

Place the Left Armrest / Leg(D), as picture above so as to be attached to the Left Armrest / Leg(D) and Seat(B) using Hardware (3) (4) with Allen Key(6) as shown in Picture3.

Do not fully tighten the bolts.

Step 3

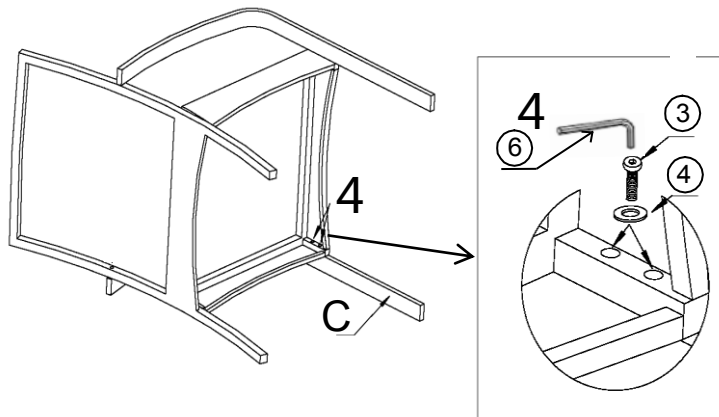

Place the Right Armrest / Leg (C) as pictured above and affix to Right Armrest / Leg(C) and Seat(B) using Hardware(③ ④) with Allen Key(⑥) as shown in Picture 4.

Do not fully tighten the bolts.

Step 4

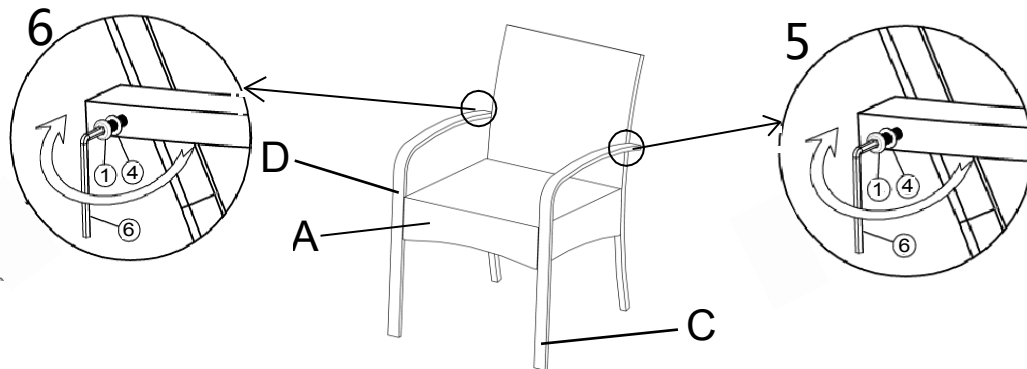

Connect the Armrest/Leg (C&D) to Backrest (A) using Hardware(① ④) with Allen Key (⑥) as shown in Picture 5 and Picture 6

Note: DO NOT fully tighten a BOLT in one go and then move on to the next. Rather, In a sequential manner, gradually tighten each Bolt until all bolts are evenly secured. This methodology will ensure maximum evenness once all Bolts are fully tightened.

Step 5

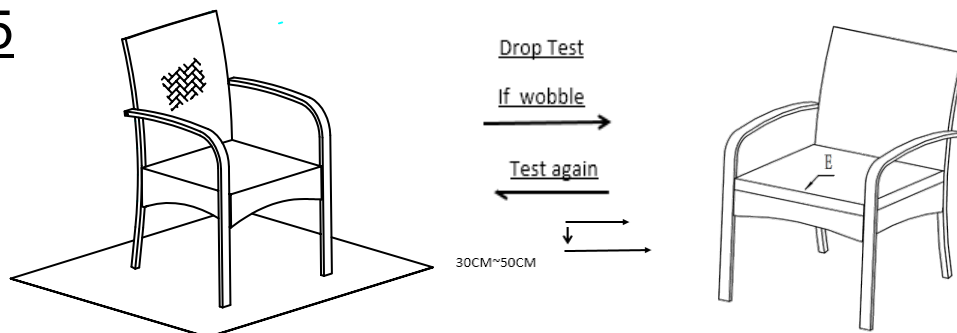

Place the Single Chair on a LEVEL SURFACE to check for wobbles.

Check for stability and then tighten all Bolts at all joints.

If it wobbles, lift the Single Chair some 30cm to 50cm high from the ground.

Keep your feet and toes well away from the drop zone.

Drop the Single Chair freely and vertically with all four legs, hitting the ground, all at the same time.

This Drop Test will help to ensure that all the Bolts and gaps reach full alignment status.

Test again for evenness on a LEVEL SURFACE.

If no wobbles are found, slowly and steadily, place the Single Chair facedown.

Then, proceed to tighten all Bolts in a sequential manner.

When tightening the Bolts, tighten sequentially.

DO NOT tighten any Bolt fully and then move on towards the next one.

This could cause the frame to warp. If there are still wobbles, loosen the Bolts and execute the same drop test.

If the Single Chair is not stable, it could lead to damage to the product.

Step 6

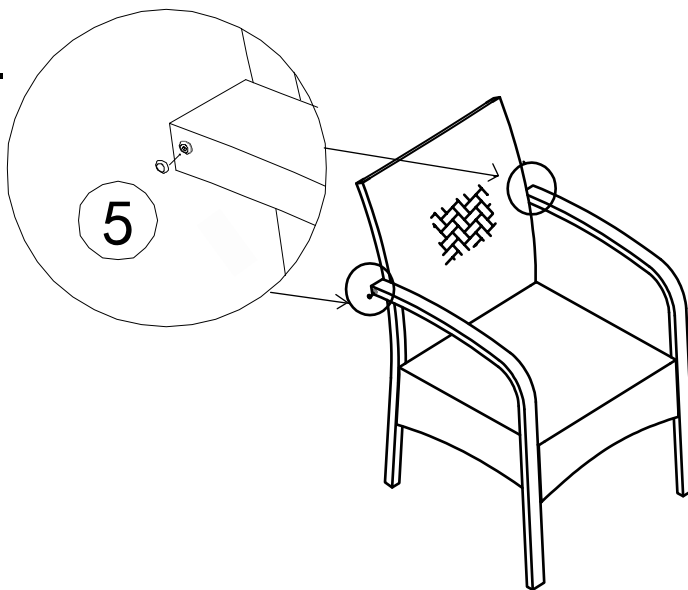

And place PE Caps(⑤) on Bolts as shown.

Step 7

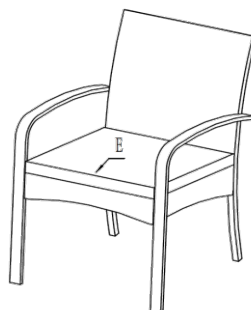





















Put the Seat Cushion(E) on the Seat.

Your Chair is ready for use.

The Chair can only be used on the flat and level surface.

Care & Maintenance

-   ● Do not put hot items directly on furniture surface
 -   ● Do not clean furniture with harsh cleansers or polish.
 -   ● To obtain the longest lifespan of your outdoor products, minimizing exposure to direct sunlight is recommended.
 -   ● Children should not climb or jump on the furniture.
 -   ● Do not write on furniture without a padded barrier to protect the surface.
 -   ● To obtain the longest lifespan of your outdoor products, avoid extended and lengthy exposure to rain, snow, and direct sunshine. Whenever possible cover the product and /or place under patio or awnings.
 -   ● Not for commercial use. For residential use only .
 -   ● Stains may be removed with mild soap solution and damp cloth.
 -   ● Keep away from sources of ignition.
-
-   ● Dust and pick-up spills using a clean, non-colored, lint-free cloth .

What is Proposition 65?

Proposition 65 is a California law that requires warning labels on products that may contain one of more than 800-plus chemicals or ingredients that the California Office of Environmental Health Hazard Assessment (OEHHA) has deemed to cause cancer or other reproductive toxicity. Chemicals and elements on this list include wood dust, brass, and other everyday substances, which can be found in very common household items, such as: lamps, tableware, jewelry, crystal glasses, electric cords, beauty products, automobiles, and furniture.

Why Did I Find a Proposition 65 Warning on My Home Goods Product?

We include Proposition 65 warnings on all of our products because there is always a chance that one of the 800-plus common chemicals and ingredients listed under this law could potentially be on our furniture or packing materials. We risk large fines under this law, if we don't include this warning.

Should I worry?

We realize you may be worried finding this warning on our products, but we want to reassure you that the hazardous exposure limits for any of these chemicals have never been found on furniture products that we've shipped to our customers. Additionally, this warning label is very common and can be found on almost every piece of furniture sold in the state of California.

Just How Common Are Proposition 65 Warnings?

Proposition 65 warnings have become so common in California that it is hard to take a trip to a local bank, grocery store, or restaurant without finding at least one warning. In fact, even the Disney Land Resort has a Proposition 65 warning:

