









ASSEMBLY INSTRUCTIONS

Ax1	 Backrest
Sx1	 Seat
Bx2	 Front leg
Cx2	 Rear leg
Dx4	 Adjust cap
Ex4	 Screw
Fx7	 Screw
Gx11	 Spring washer
Hx13	 Flat washer
Kx1	 Allen key
Lx1	

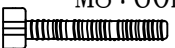
① The legs are hidden under the seat frame

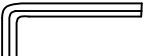
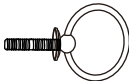
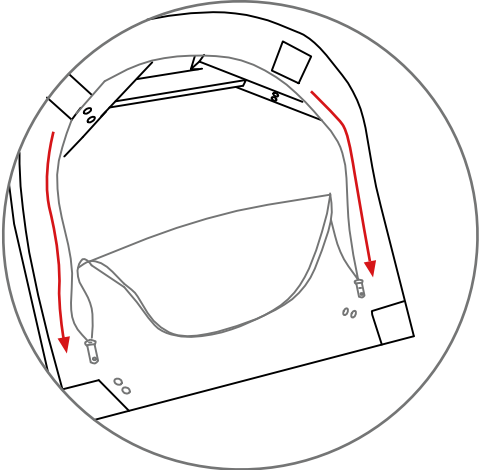

②

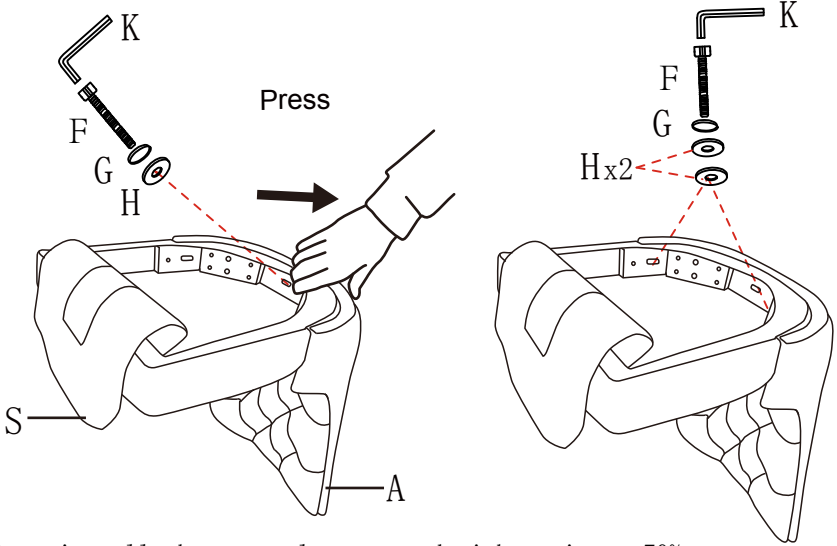

Press

First install the central screw and tighten it to 70%, then install the screws on both sides and tighten them to 80%

③

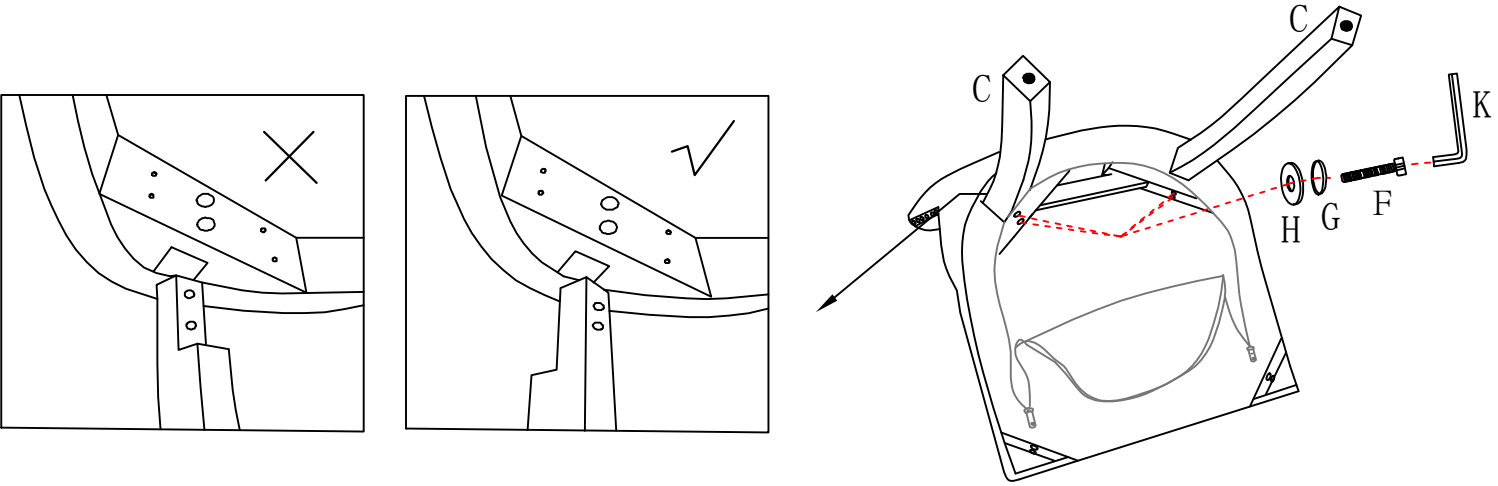

Tighten all the screws to 80% of maximum tightness

WARNING:

DO NOT STAND ON THE PRODUCT, DO NOT USE THIS PRODUCT AS A STEP LADDER.
DO NOT USE THIS PRODUCT UNLESS ALL BOLTS, SCREWS AND KNOBS ARE FIRMLY SECURED.
PLEASE DO NOT USE KNIFE TO OPEN ANY PARTS OF THE BOX OR PRODUCT.

④

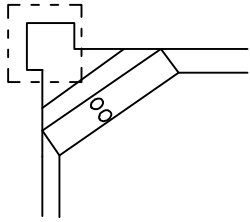

Put the front leg in the dotted box place, if you put it in the wrong place, it still can work, but the uneven force will cause the leg to break.

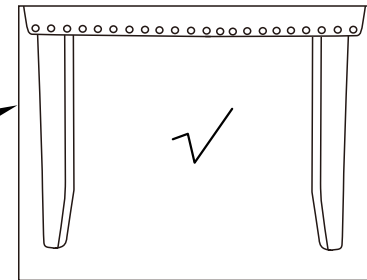
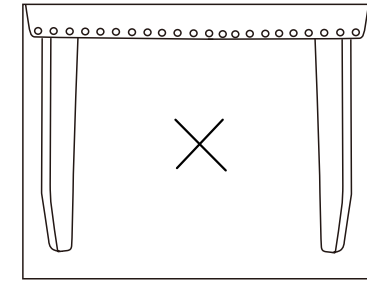
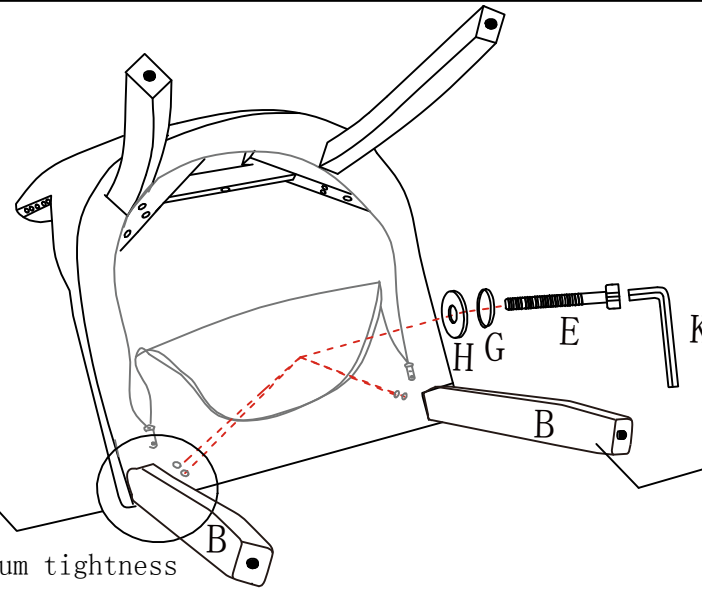

Tighten all the screws to 80% of maximum tightness

⑤

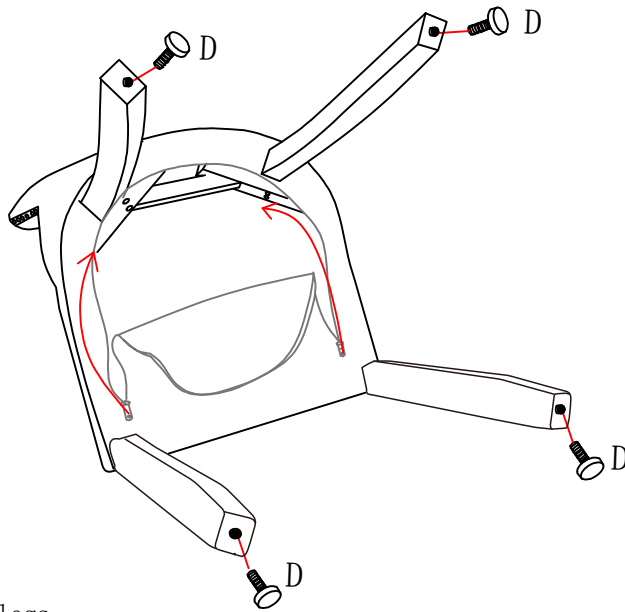

1. screw D into legs.
2. Carefully sit on the chair and make adjustments to ensure the legs are flat even on the floor.
3. Tighten all the screws to 100% of maximum tightness
4. Close the zipper of bottom Non-Woven fabric.

⑥

There are 4 small adjusters on the legs, ensure these are adjusted so the chair sits level.

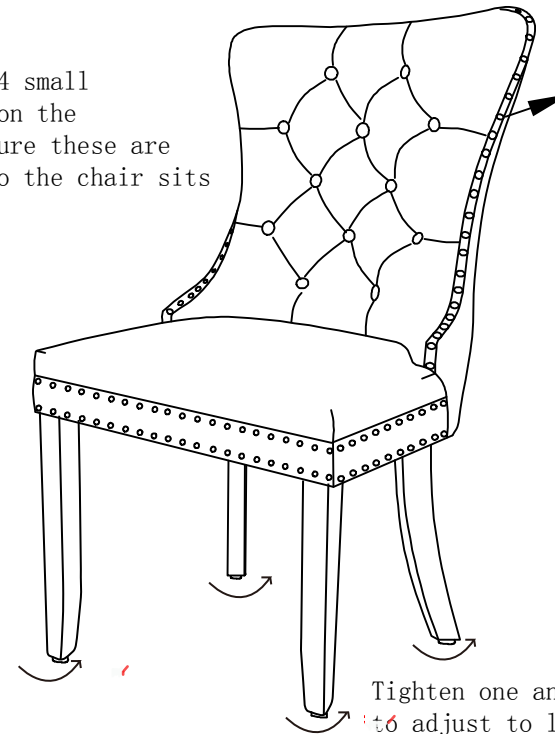

Tighten one and loosen the other, to adjust to level.