

Parts Details

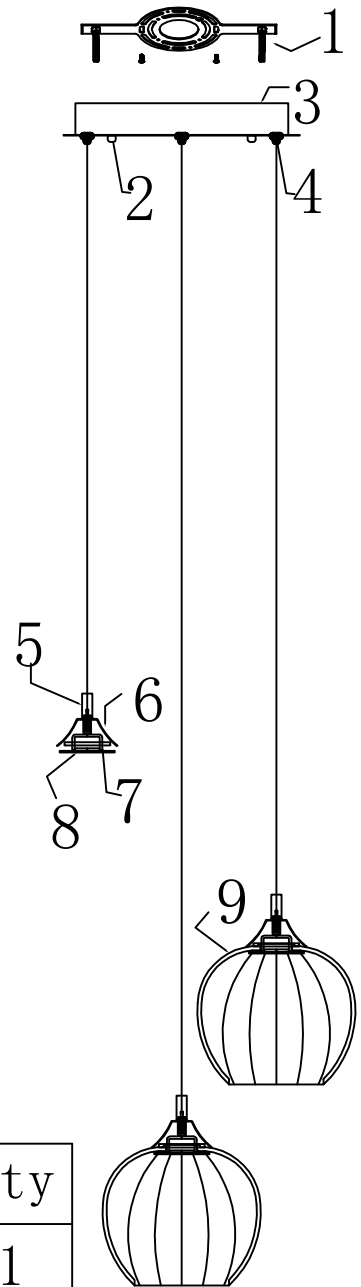
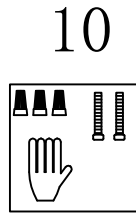
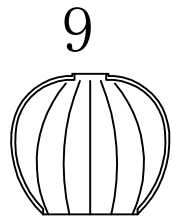
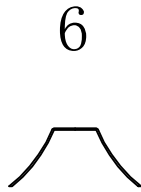
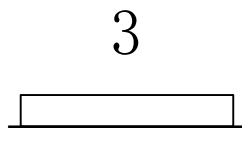
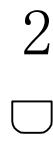
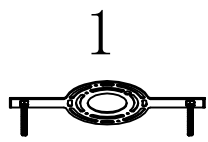

No.	Material	Parts	Qty
1	Mounting Bracket	Zn	1
2	M6 Internal Locking Piece	STL	4
3	Main Canopy	IR	1
4	Cable Adjuster	IR	3
5	Male & Female Connector Assembly	/	3
6	Horn Shade	IR	3
7	Light Source Assembly	/	3
8	Light Source Lens Component	PMMA	3
9	Glass Component	Glass	3
10	Hardware Kit	/	1

WARNING (To reduce the risk of fire, electric shock, or personal injury):

1. We suggest installation by a licensed electrician.
2. Please read the instruction carefully and save it as you may need it at a later time.
3. Before you start, NEVER attempt any work without shutting off the electricity until the work is done.
» Go to the main fuse, or circuit breaker, box in your home.
Place the main power switch in the "OFF" position.
» Place the wall switch in the "OFF" position.
4. Mounting surface should be clean, dry, flat, strong enough and 1/4" larger than the canopy on all sides. Any gaps between the mounting surface and canopy exceeding 3/16" should be corrected as required.
5. Make sure that the ceiling or wall can stand the weight of the lamp before installation.
6. Make sure the voltage you are using is 120V.
7. Keep the lamp away from acidic and alkaline substances in case of damaging the surface of the lamp.
8. When replacing bulbs, you should turn off or unplug the lamp and you must wait until it is cool as bulbs get hot quickly.
9. The safety instructions appearing in this manual are not meant to cover all possible conditions that may occur. It must be understood that common sense, caution and care must be used with any electrical products.

IMAGE FOR FINISHED PRODUCT:

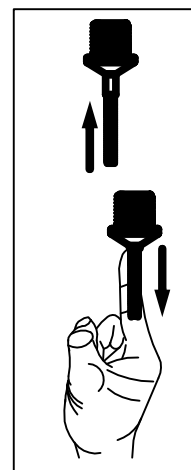
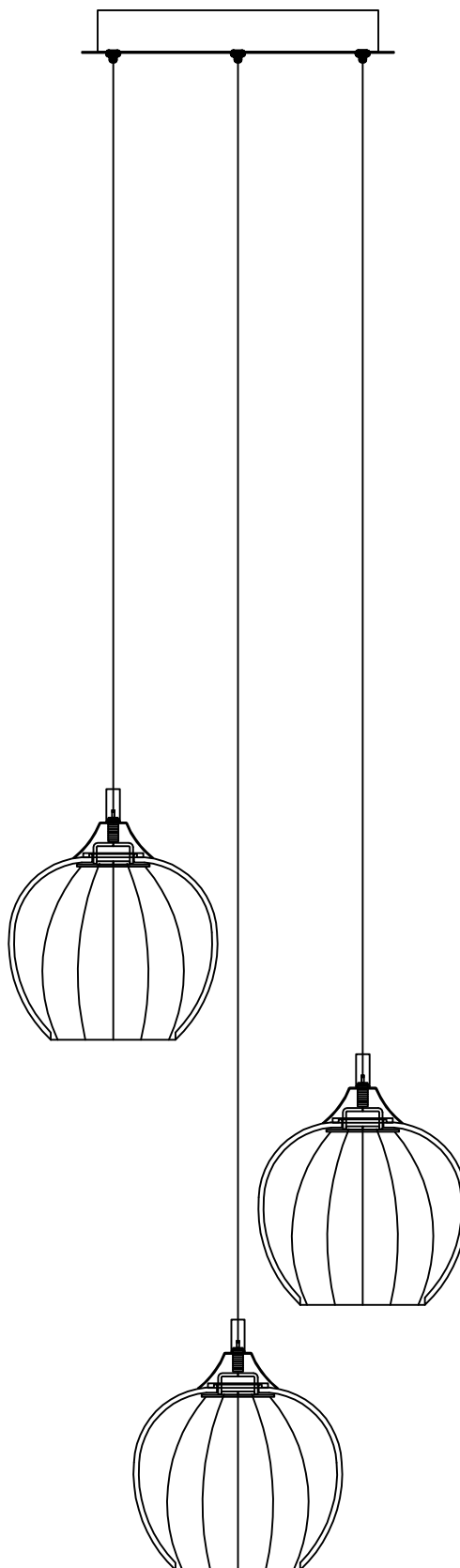

Caution: Please turn off power before installation and read the manual carefully, we advise you contact professional electricians to install for safety purpose. Product Features
LED LAMP: AC120V/60HZ 3000K 15W

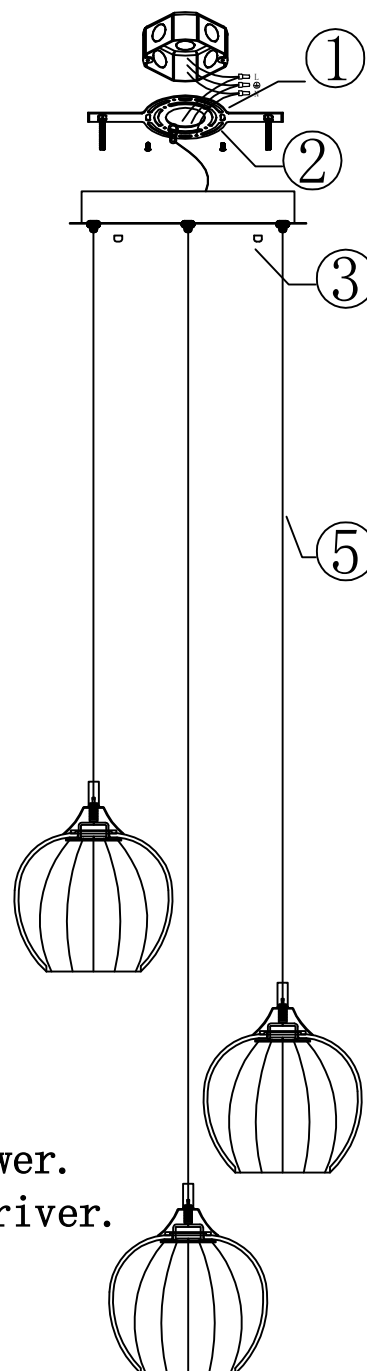
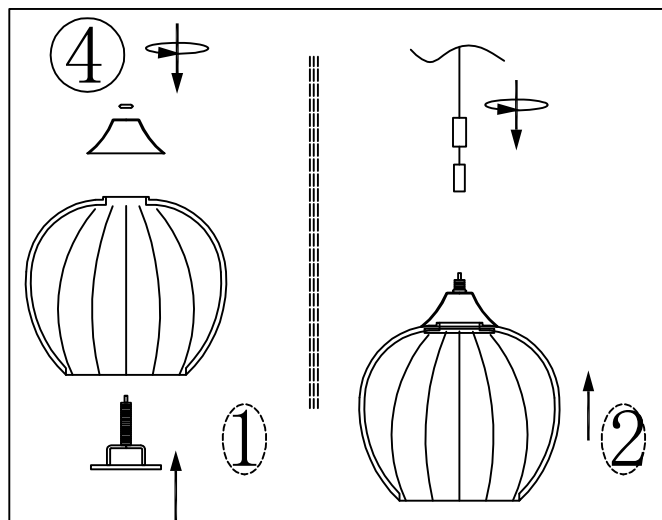

Must connect all lights, then open the power.
Because one light cannot undertake the driver.

Installation Instructions

- Fix the hanging plate to the junction box with junction box screws, make sure the wires pass through the reserved hole of the hanging plate. (1)
- Connect the live wire (L) of the main wire to the positive wire (+) of the junction box with terminal caps; similarly, connect the neutral wire (N) to the negative wire (-) with terminal caps. Ensure no wires are exposed to prevent electric leakage. Use the green screw to fasten the lamp's grounding wire (green wire & brass wire), the main wire and the external grounding wire together on the ceiling plate. (2)
- Hang the whole lamp body on the hanging plate and fasten tightly with M4 female thread fittings to secure the lamp firmly. (3)
- then lock tightly with the female thread washer fitting to form an integrated light source assembly. Connect the light source assembly to the male and female plug set of the lamp body suspension wire and lock it securely. (4) Adjust the height of the lamp body suspension wire according to actual needs. (5)
Caution: Please use this product strictly for its intended purpose, do not retrofit or modify the product.
Any failure caused by third-party products or natural disasters is not covered by the warranty.

①

Unscrew the round decorative internal thread nut upward.

Loosen the trumpet trim kit and light source kit separately.

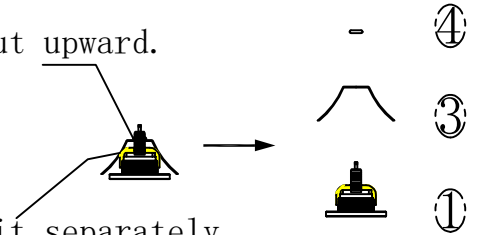

②

4: Screw down the round internal thread decorative nut onto the outer long tube and tighten securely.



3: Fit the horn-shaped trim down over the upper lip of the glass part.



2: Slide the glass ornament downward into position.

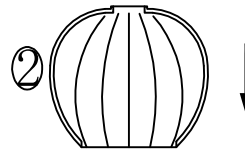

1: Fix the light source kit at the designated fixing point.

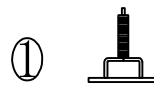

Rendering of Light Source Decoration Kit

