

3 Seater Recliner Sofa

Operating Instruction

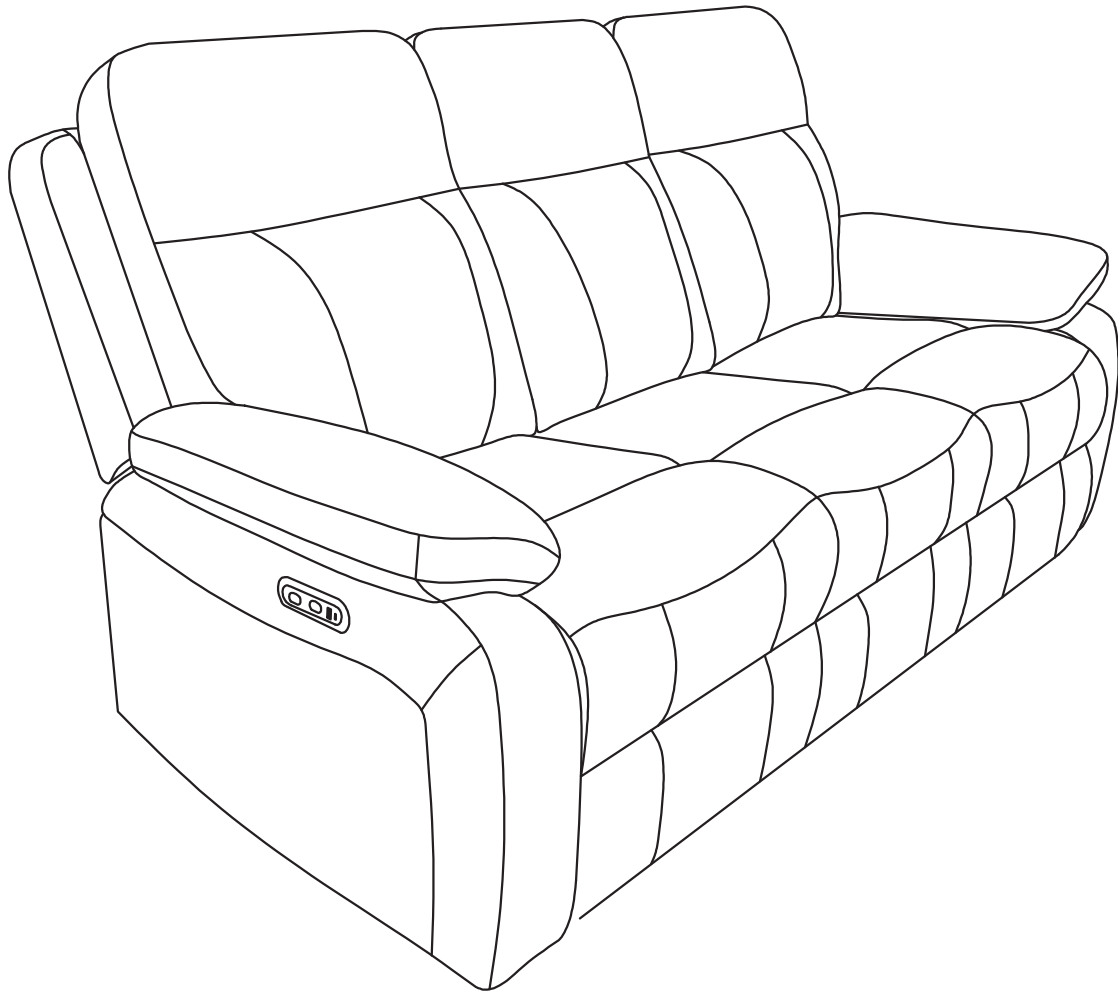

NOTE: This sofa is shipped in 4 boxes. All accessories included. If you have any questions after receiving the sofa, please contact us in time and provide pictures. We will try our best to help you solve it.

! ATTENTION

Thanks for choosing our product.

1. There will be 4 boxes in total for this whole product. Please check the manual carefully and make sure you have received all the parts.
2. If there is any missing or damaged parts, please let us know the name and number of the parts you need.
3. If there is any damage parts, please send clear photos to us, we will check and offer you best solution soon.
4. There may be a little color difference between the picture and the real thing.
5. Unplug all powder cord and wires connection from socket before move chair. Disconnect all the power when not in use.
6. If the heating is not obvious, we commend you heat it for a longer time, or add a blanket.



Do not smoke or play with fire

Parts Listing

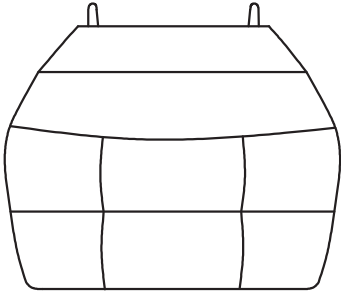
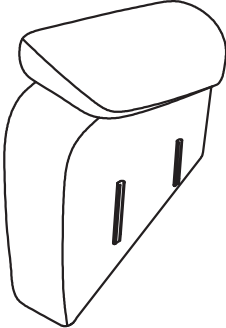
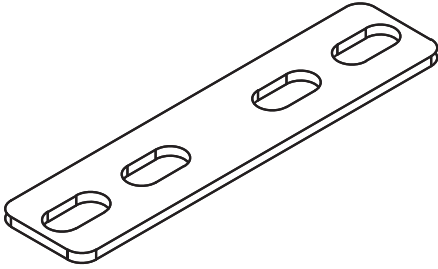
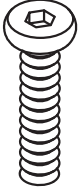
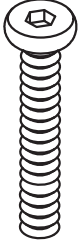
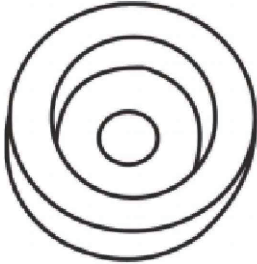
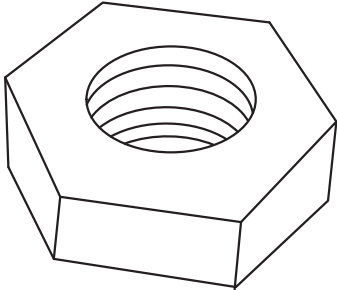
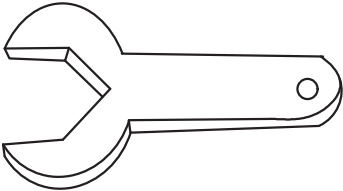
BOX A					
Part	Description	Qty	Part	Description	Qty
A1		1PC	A2		1PC
E		4PCS	F	 M6*20	9PCS
G	 M6*30	5PCS	H		5PCS
I		9PCS	J		1PC

Parts Listing

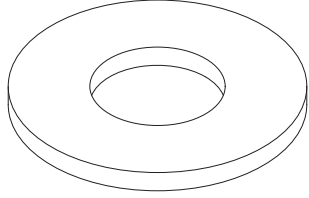
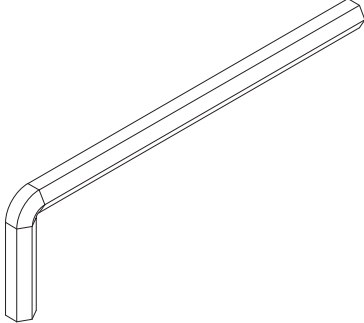
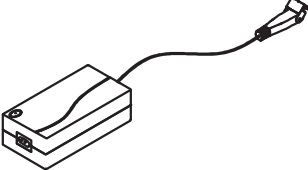
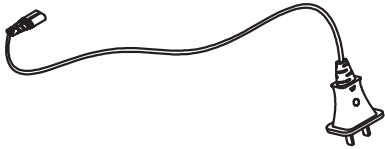
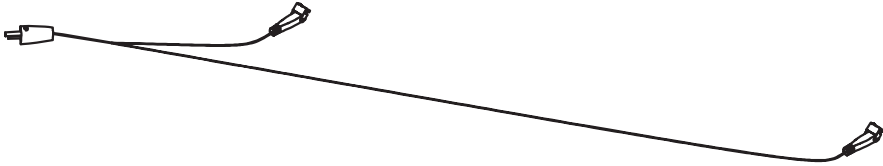
BOX A					
Part	Description	Qty	Part	Description	Qty
K		13PCS	L		1PC
M		1PC	N		1PC
O					1PC

Parts Listing

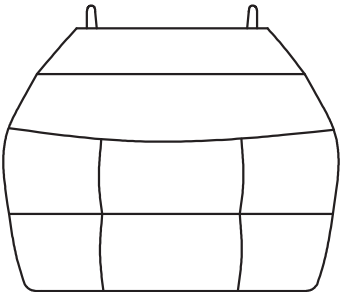
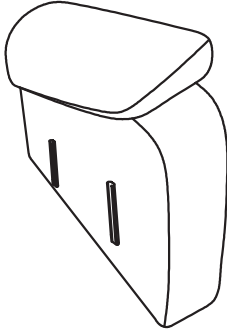
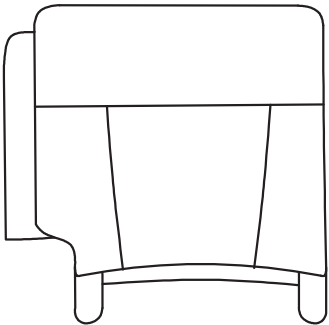
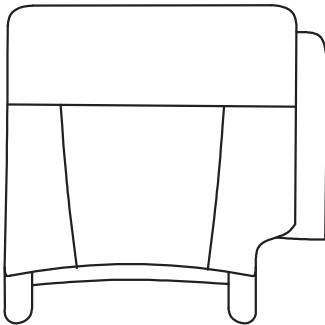
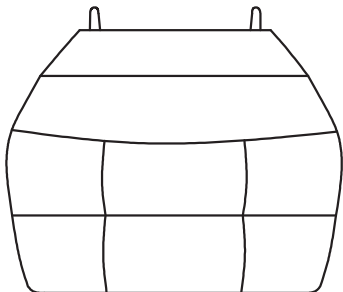
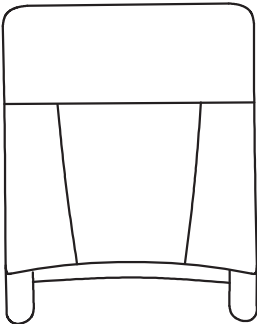
BOX B					
Part	Description	Qty	Part	Description	Qty
B1		1PC	B2		1PC
BOX C					
C1		1PC	C2		1PC
BOX D					
D1		1PC	D2		1PC

Step 1



Note:

For the convenience to adjust parts connection, never fully tighten the screws until you finish the installation, tighten screws to 80%-90% is enough.

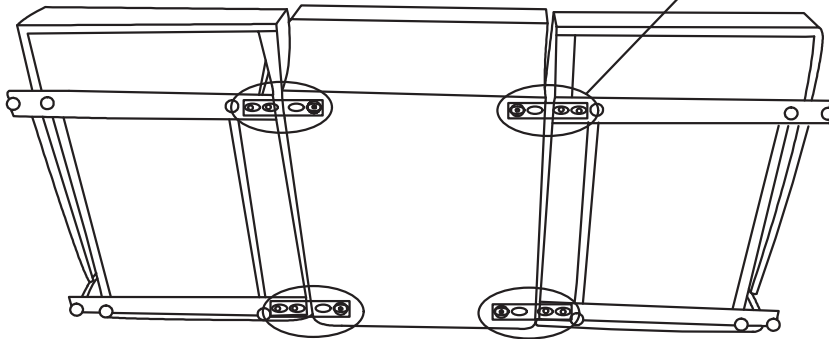
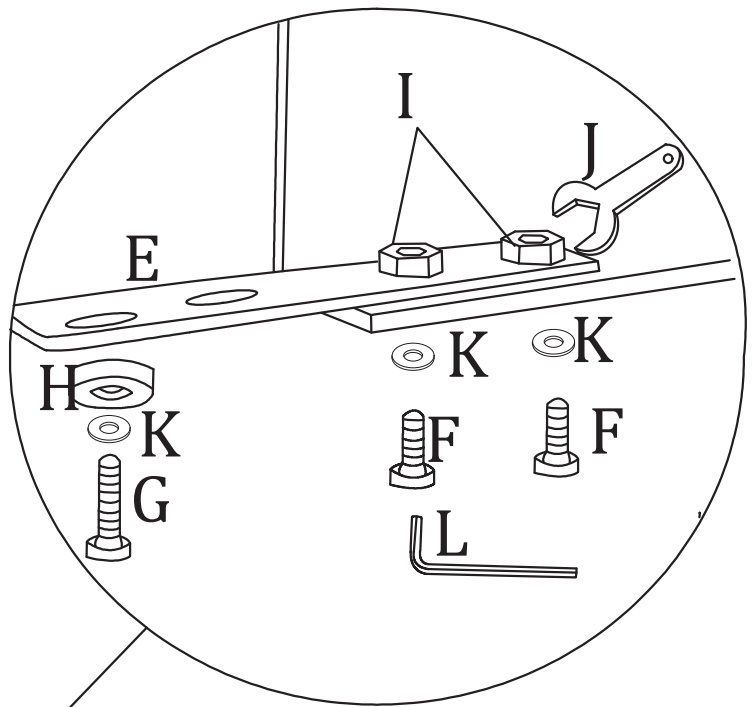

Accessories: Part A1*1,Part B1*1,Part C1*1,Part E*4,Part F*8, Part G*4, Part H*4, Part I*8, Part K*12, Part J*1, Part L*1

Installation Steps :

- 1、 Turn the three seat bases upside down and align them side by side.
- 2、 Use four metal plates (Part E), two at the front and two at the back, to connect the left,middle and right bases together.
- 3、 Install the metal plates (Part E) on the left and right bases. Insert the screws (Part F) through the washers (Part K), align them with the holes on the metal plates, and fasten them securely using the nuts (Part I) .
- 4、 Attach the metal plate to the middle base.Insert the screws (Part G) through the washers (Part K) and foot pad (Part H), align it with the hole on the metal plate, and tighten it firmly. Only one hole needs to be installed for this step.

Step 2

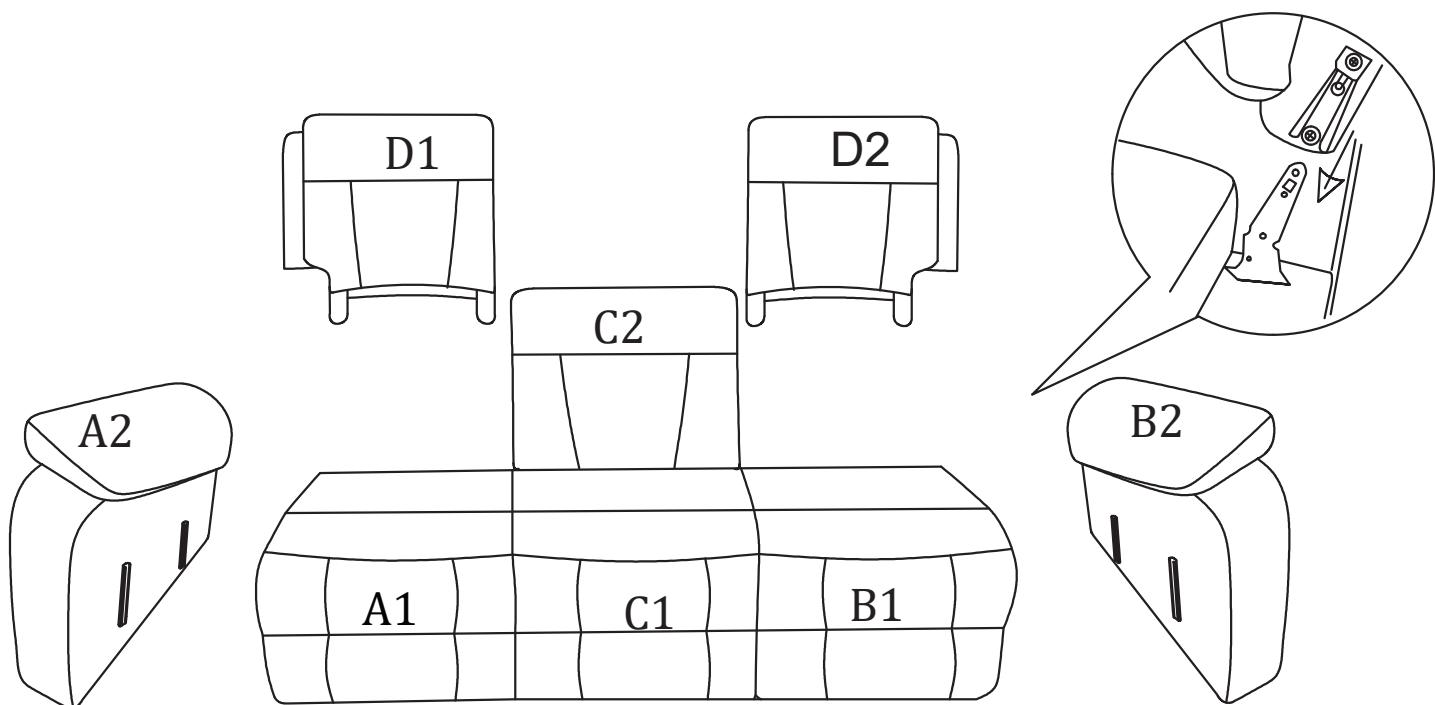

Accessories: Part A2*1, Part B2*1, Part C2*1, Part D1*1, Part D2*1,

Installation Steps :

- 1、 Insert left and right armrests (Part A2 Part B2) into the bases (Part A1 Part B1), align the slot and press down to ensure it snaps in properly.
- 2、 Align the backrests (Part D1 Part C2 Part D2) with the slot on the bases (Part A1 Part C1 Part B1) separately and insert them firmly, when you hear a click that's correct installation.

Step 3

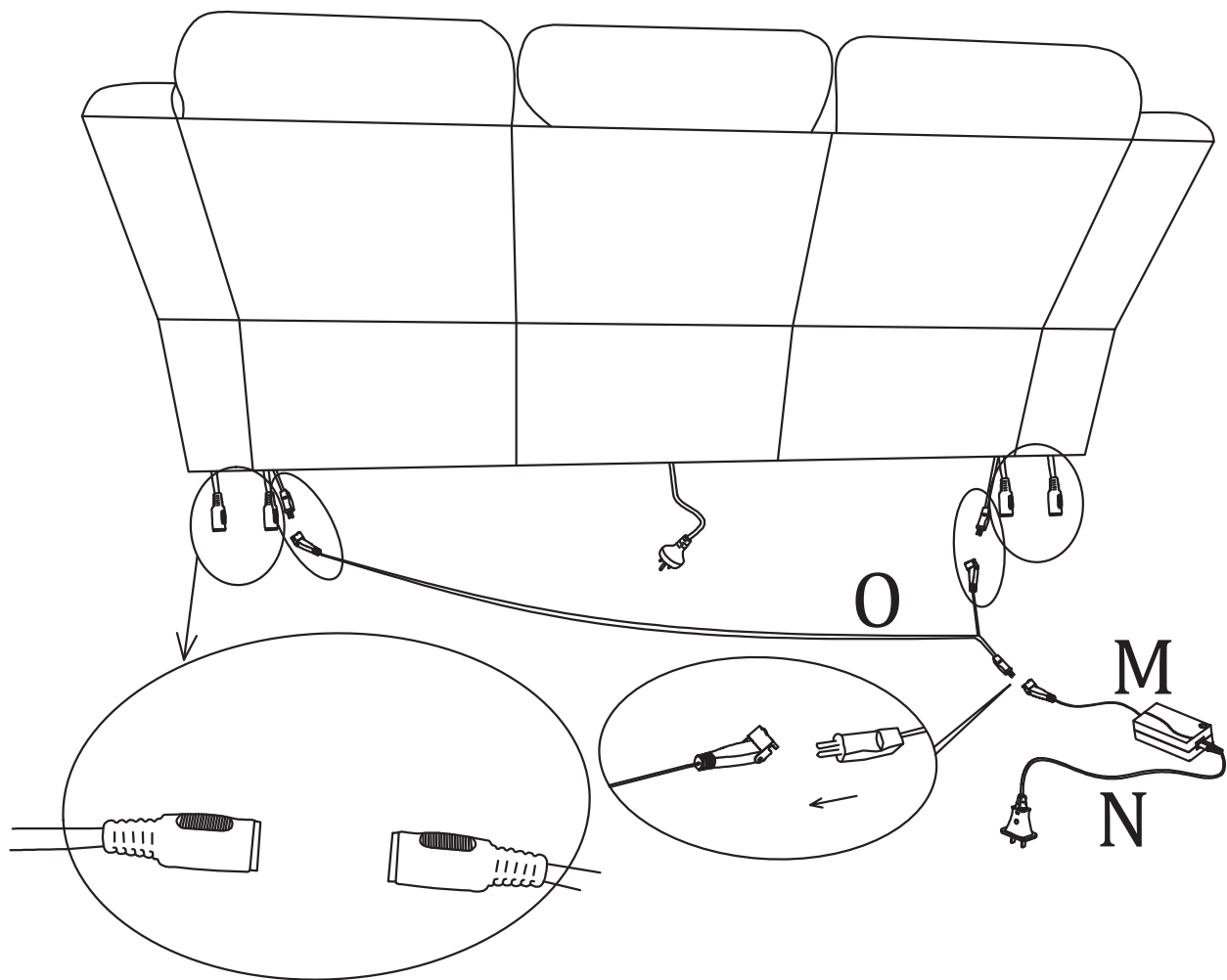

Accessories: Part M*1, Part N*1, Part O*1

Installation Steps :

- 1、 Connect the wires located at the bottom of both armrests to the matching connectors on the seat base.
- 2、 Connect the Y-shaped cable (Part O) to the corresponding connectors on the left base and right base.
- 3、 Connect the other end of the Y-shaped cable (Part O) to the transformer (Part M), then connect the transformer (Part M) to the power plug (Part N).

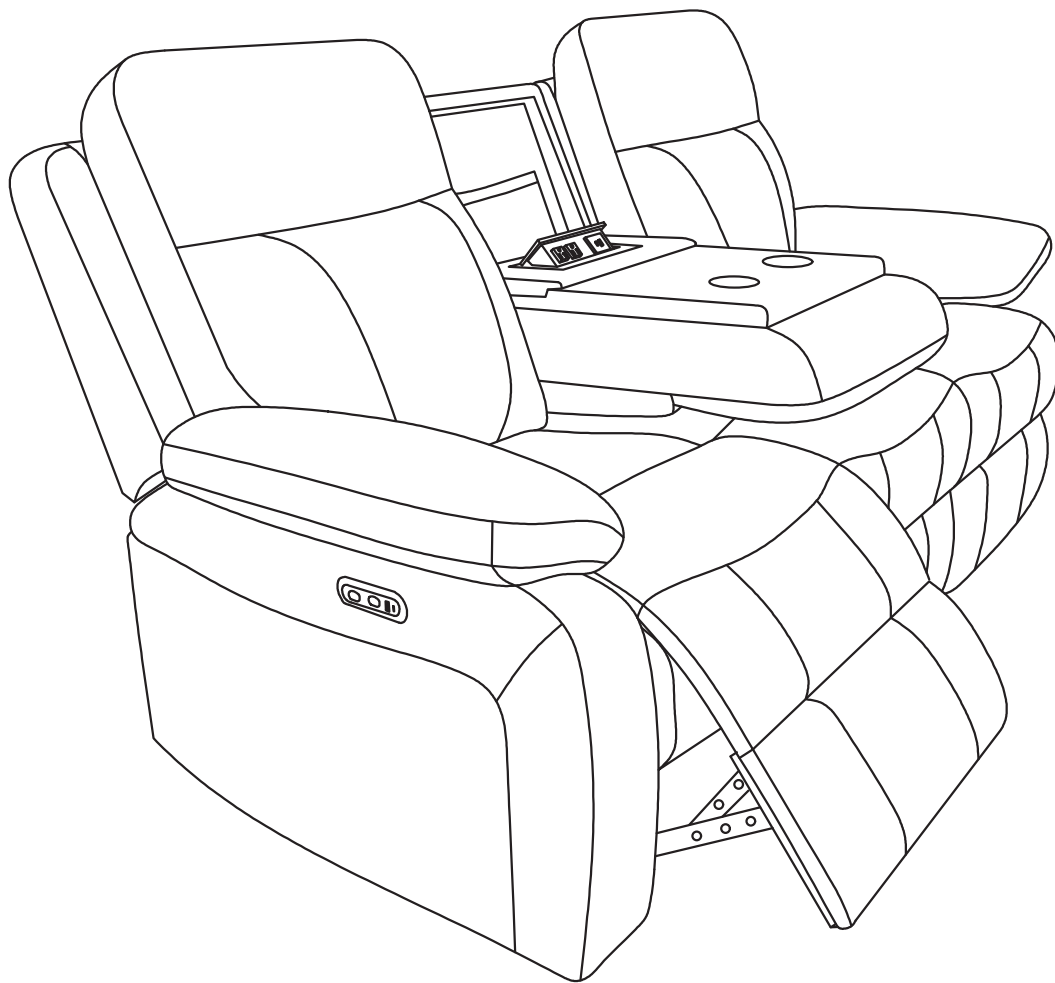

Congratulations on completing the assembly! You can now use your power recliner sofa. After powering it on, you can control the tilt angle of the sofa using the button located beside the armrest. Additionally, the middle backrest can be flipped down to become a storage console with two cup holders. We hope you enjoy your new sofa.

Note: Please disconnect the power when the sofa is not in use to prevent accidents.