

Assembly Instructions
Instructions de montage
Инструкция по сборке

Instrucciones de montaje
Istruzioni di montaggio
Montageanweisung

⚠ WARNING: Adult assembly required.

Imprescindible la ayuda de un adulto para el montaje.

Assemblage par un adulte requis.

È richiesto un adulto per l'assemblaggio.

Care Instructions

To clean your product, use mild soap and water on a damp cloth. Do not use window cleaners or cleaning abrasives as they will scratch the surface and could damage the protective coating.

Instrucciones de mantenimiento

Para limpiar el producto, use un paño humedecido con jabón suave y agua. No use ni limpiacristales ni limpiadores abrasivos porque dañan la superficie y podría estropear la capa protectora.

Précautions d'emploi

Pour nettoyer le produit, utilisez du savon doux et de l'eau sur un chiffon humide. N'utilisez pas de produits à vitre ou d'abrasifs nettoyeurs car ils rayeraient la surface et pourraient abîmer la couche protectrice.

Manutenzione

Per la pulizia del prodotto, usare acqua tiepida e sapone su un panno umido. Non usare detergenti per vetri o prodotti abrasivi poiché potrebbero graffiare la superficie e danneggiare il rivestimento protettivo.

5 Year Warranty

We certify that your product is warranted to be free from defects in material and craftsmanship for a period of five (5) years from the date of purchase. This warranty does not apply to damage caused by abuse, misuse, or altered product. This warranty is limited to the original purchaser with proof of purchase and is nontransferable. The manufacturer's liability under this warranty is limited to the repair or replacement of the defective product, at the manufacturer's sole option.

5 Años de Garantía

Certificamos que nuestro producto tiene garantía de estar libre de todo defecto material y de construcción durante un período de cinco (5) años desde la fecha de compra. Esta garantía no se aplica a los daños causados por abuso, mal uso o alteración del producto. Esta garantía está limitada al comprador original siempre que muestre la prueba de compra y no se puede transferir.

5 Ans de Garantie

Nous certifions que votre produit est garanti exempt de tout vice de matériaux et de fabrication au cours d'une durée de cinq (5) ans à compter de la date d'achat. Cette garantie ne s'applique pas aux dommages causés par une utilisation abusive, d'une mauvaise utilisation ou d'une altération du produit. Cette garantie est limitée au premier acheteur avec une preuve d'achat et n'est pas transférable.

5 Anni di Garanzia

Certifichiamo che il prodotto è garantito come esente da difetti nei materiali e nella lavorazione per un periodo di cinque (5) anni dalla data di acquisto. Questa garanzia non si applica ai danni causati da abuso, uso improprio, o in caso di prodotto alterato. Questa garanzia è limitata all'acquirente originale con prova di acquisto e non è trasferibile.

Parts and Hardware
Piezas y herrajes
Pièces et Matériel
Parti e hardware
Детали и оборудование
Bestandteile

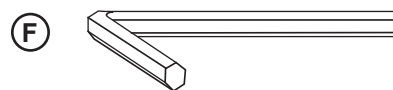
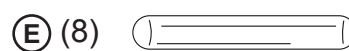
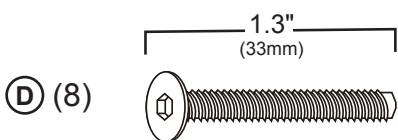
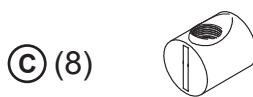
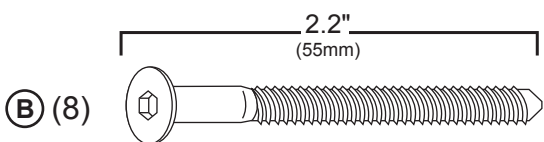
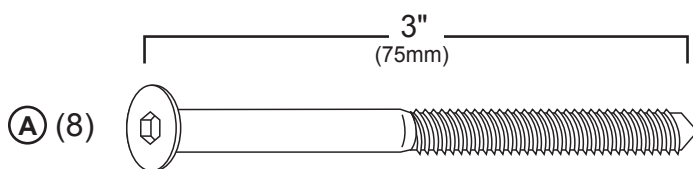
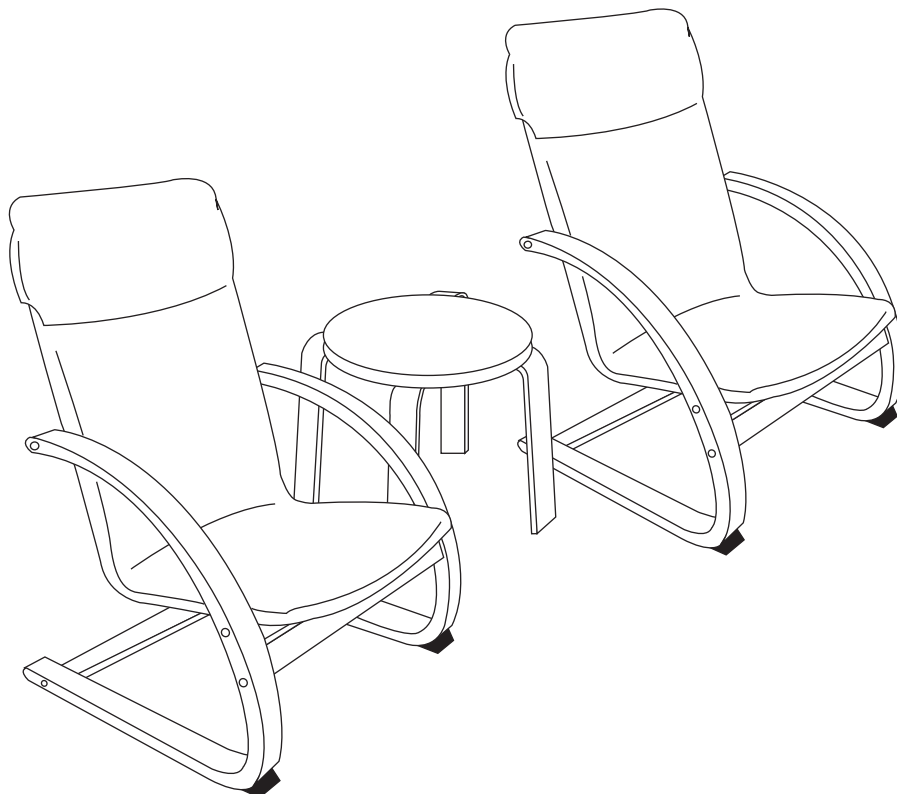

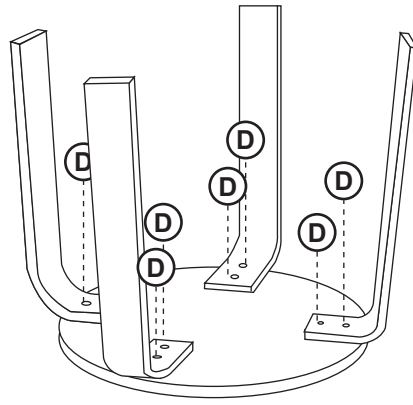

1

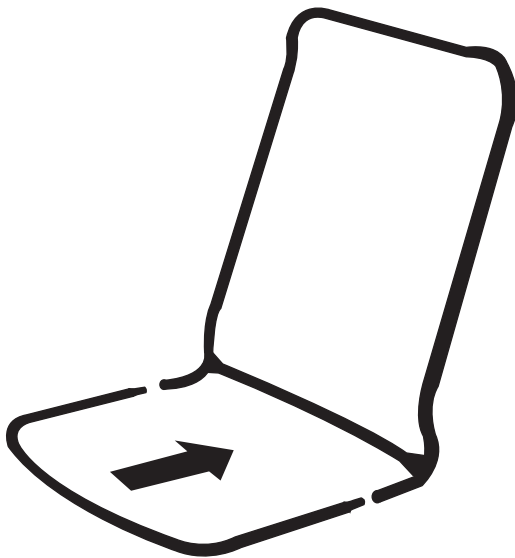

2

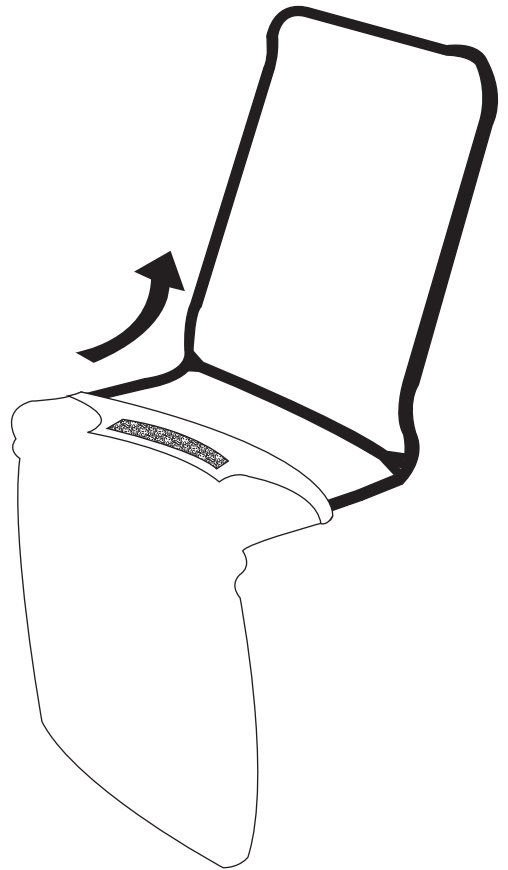

3

Ensure the holes in the fabric cover line up with the holes in the metal frame after the cover is attached. If the holes do not line up, you may have installed the cover upside down.

BURN HOLES IN COVER

Please note: The holes in the cover are burned at the edges to prevent fraying. They are not a product flaw.

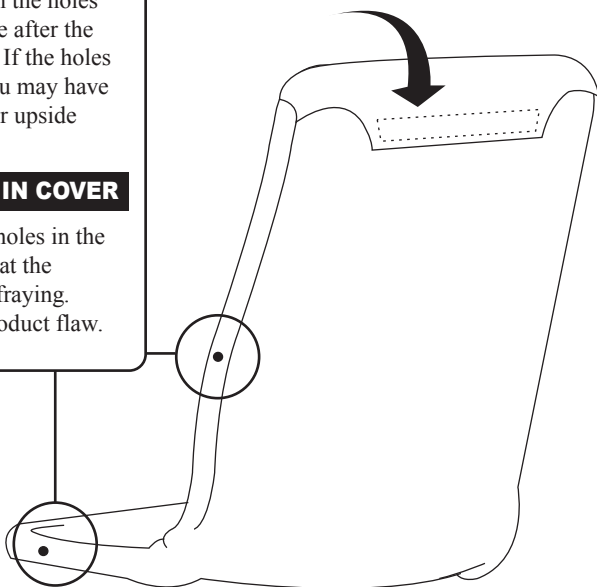

4

