

3 Piece Outdoor Rocking Chair

If you have any questions about the Outdoor Rocking Chair, Please feel free to contact us.

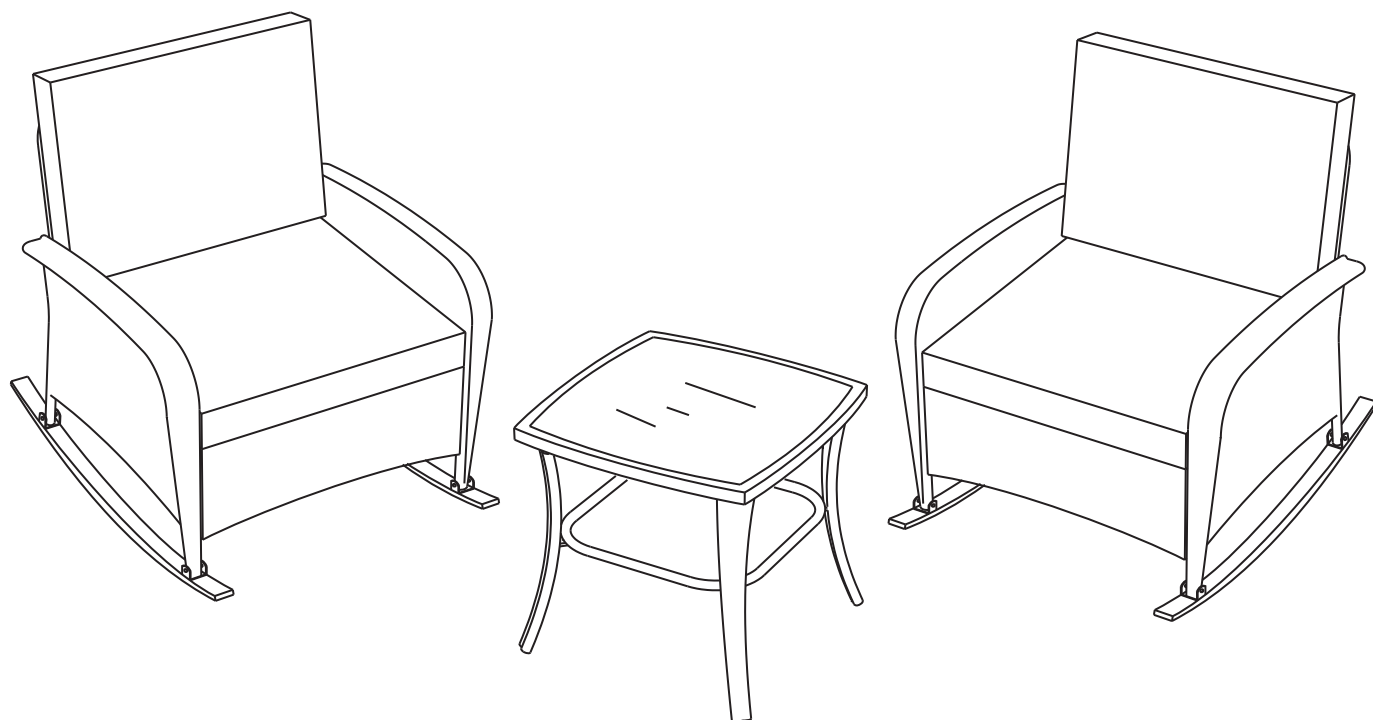

NOTICE

Please retain these instructions for future reference.

Dear Customer

Thank you for your purchase.

When you receive the product, please make sure that all the parts are intact.

Then please browse the entire installation manual before assembly.

If problem occur unsatisfactorily as follows

- A . The outer box is damaged
- B . The product is damaged / bent / cracked while you open the box
- C . The parts / accessories / assembly tools are missing
- D . The product is hard to assemble
- E . The instructions are not clear and can not be referred
- F . The product has functional problems
- G . Other aspects that you are not satisfied with

Please do not hesitate to contact us for help. Our team with factory direct after-sales service will reply within 24 hours and will do our best to resolve the problem for you.

HARDWARE

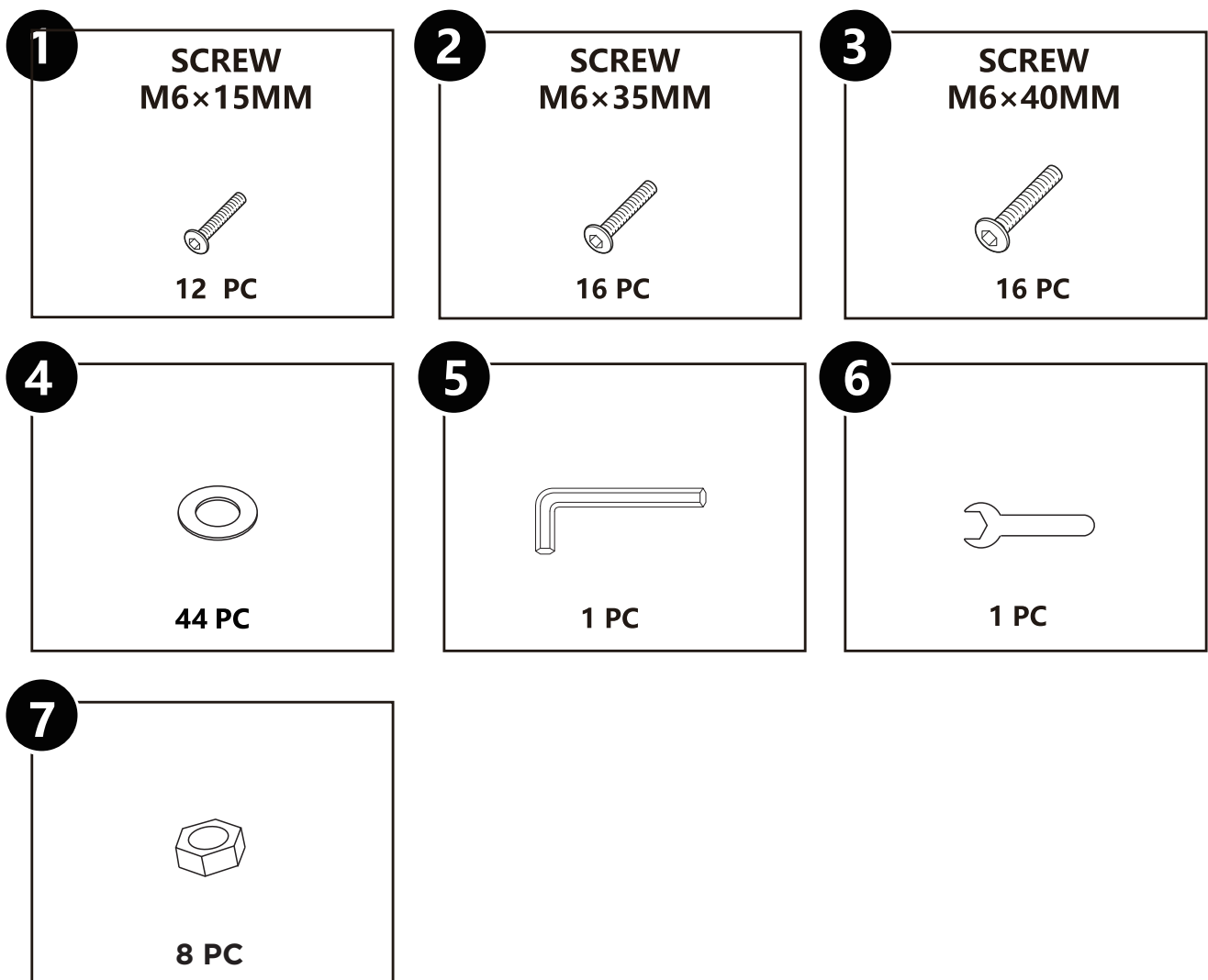

PARTS

A

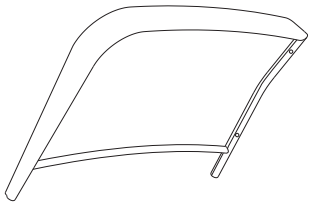

2 PC

B

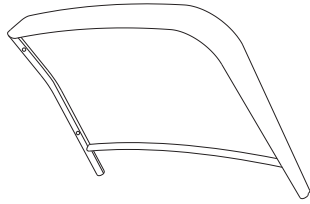

2 PC

C

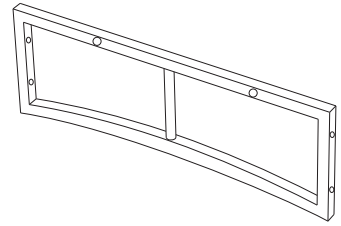

2 PC

D

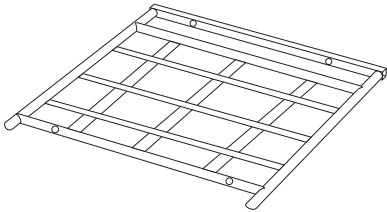

2 PC

E

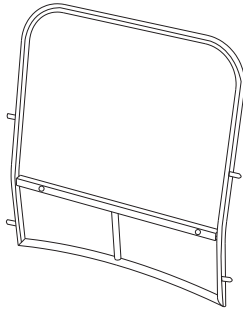

2 PC

F

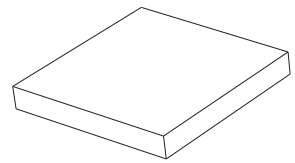

2 PC

G

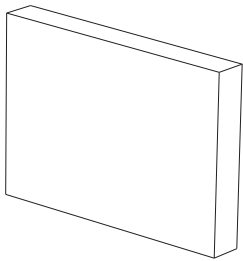

2 PC

H



4 PC

I

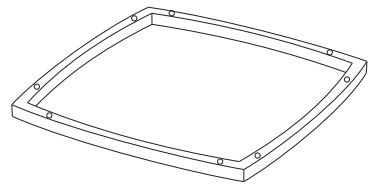

1 PC

J

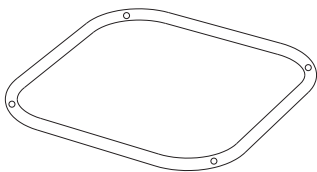

1 PC

K



4 PC

PRODUCT ASSEMBLY - SINGLE CHAIR

Step 1

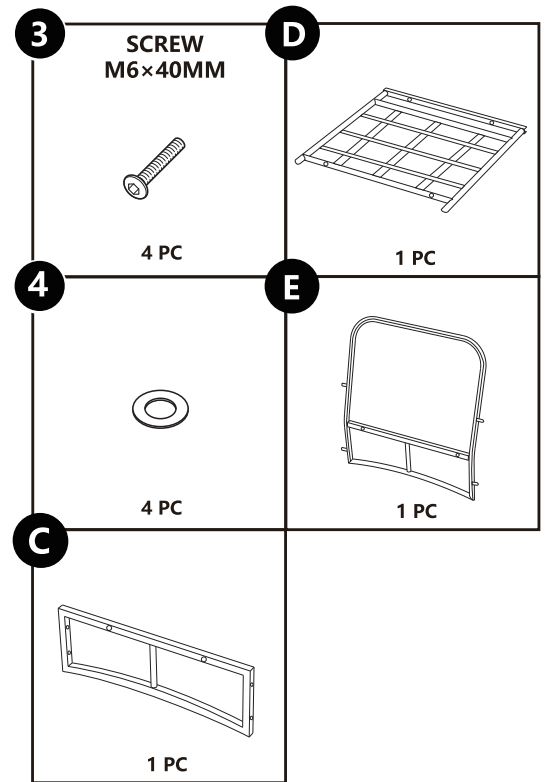
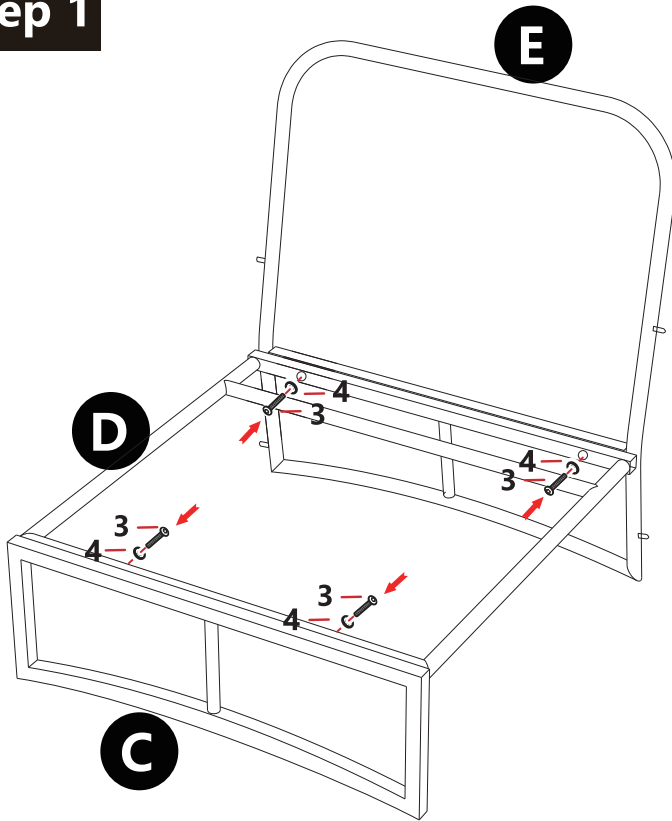

PRODUCT ASSEMBLY - SINGLE CHAIR

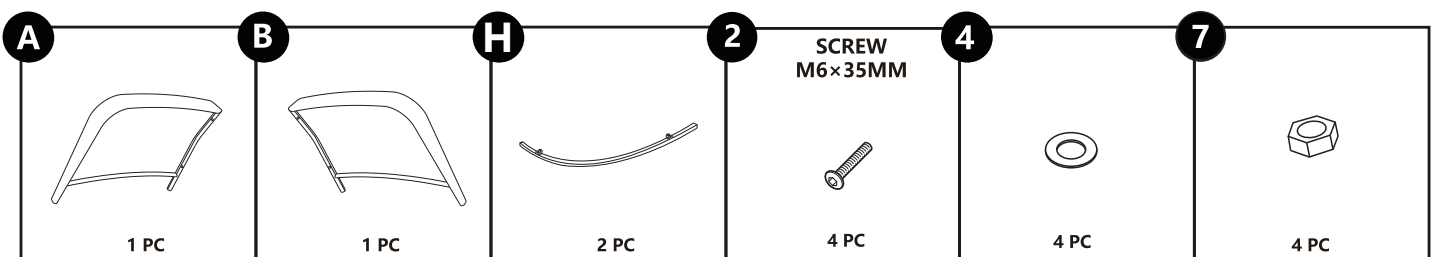
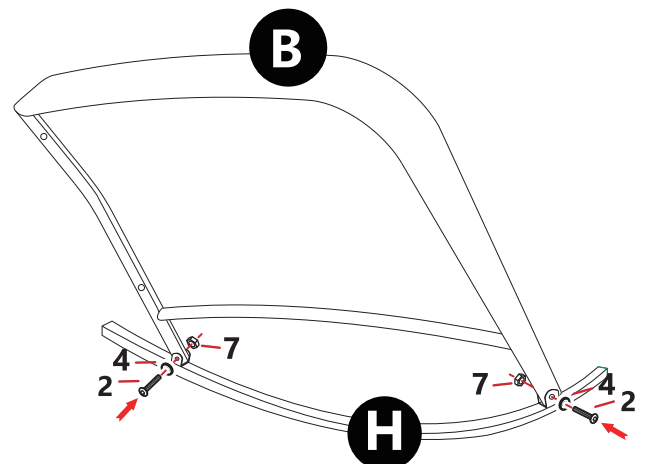
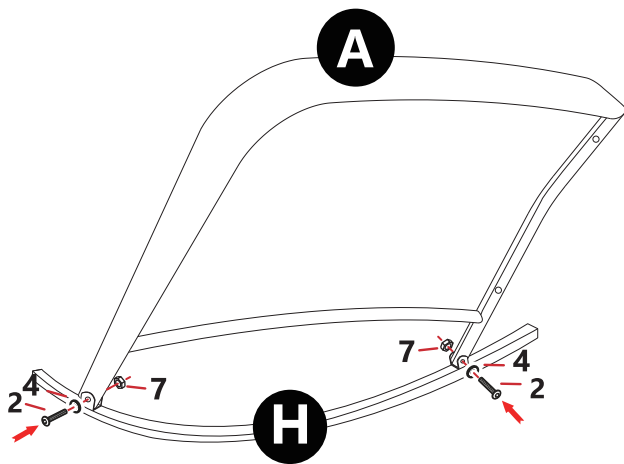

Step 2

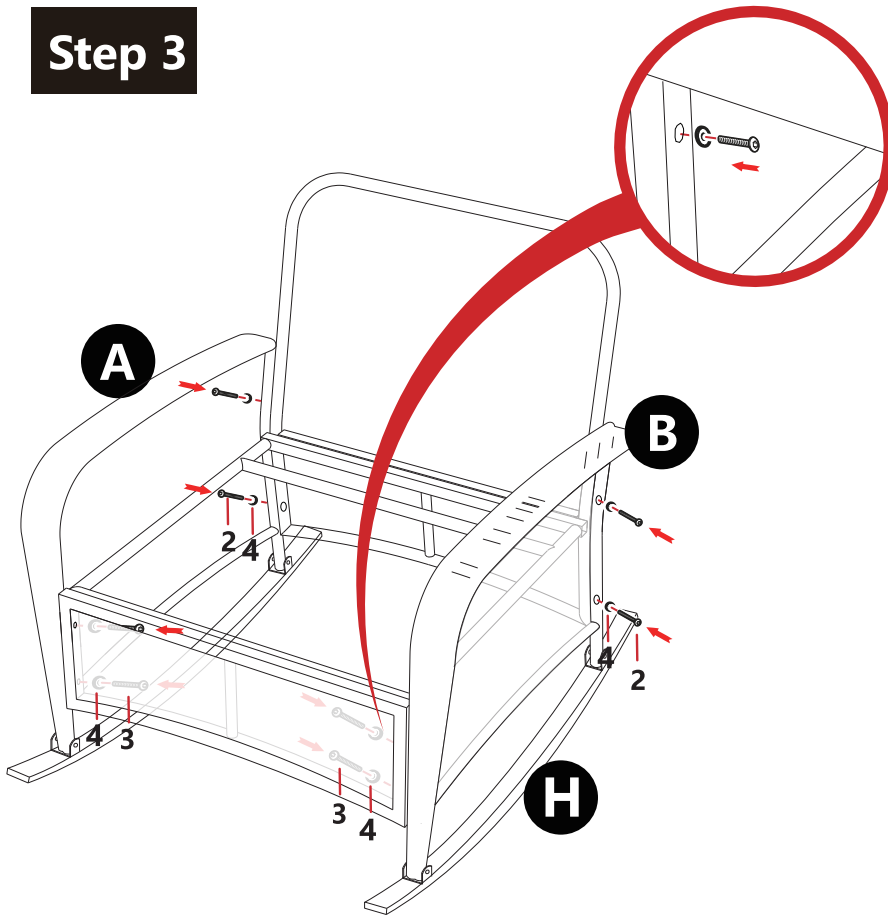

PRODUCT ASSEMBLY - SINGLE CHAIR

Step 3



2	SCREW M6×35MM
	
	4 PC
3	SCREW M6×40MM
	
	4 PC
4	
	8 PC

PRODUCT ASSEMBLY - SINGLE CHAIR

Step 4 Repeat to build another

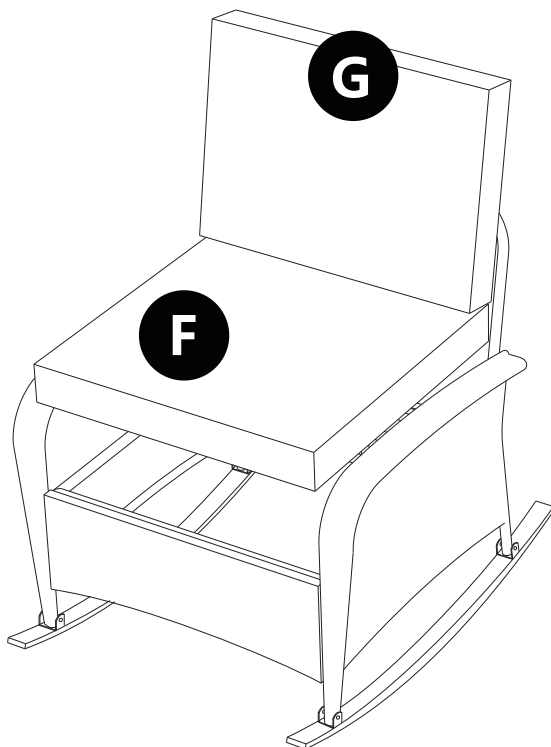



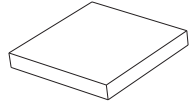
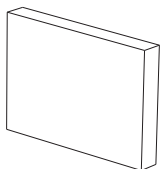

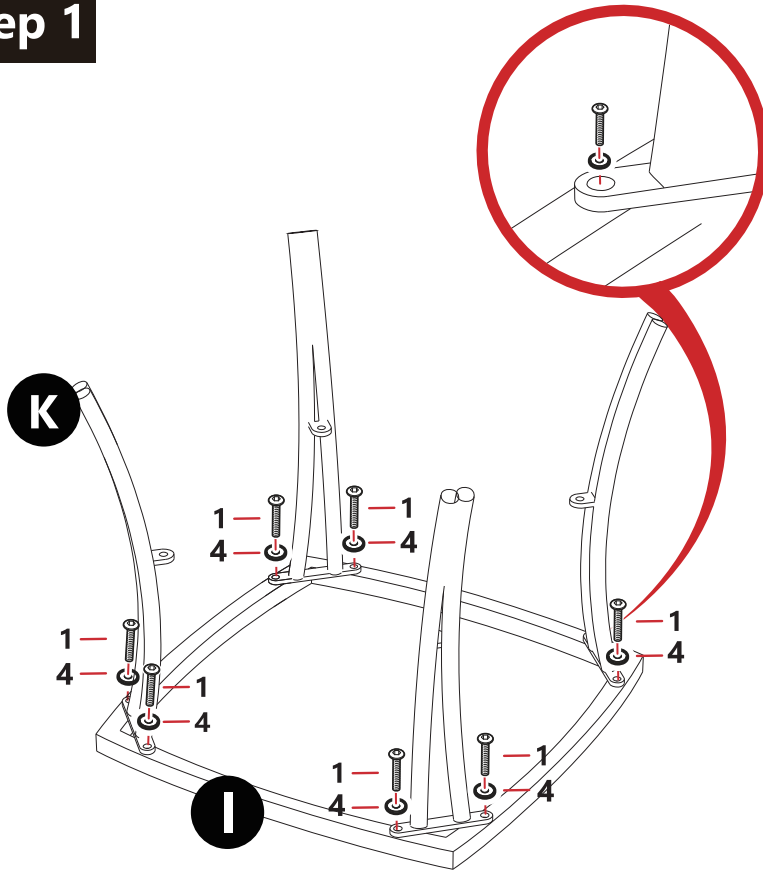

x2

F	
	1 PC
G	
	1 PC

PRODUCT ASSEMBLY - TABLE

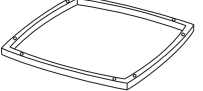
Step 1





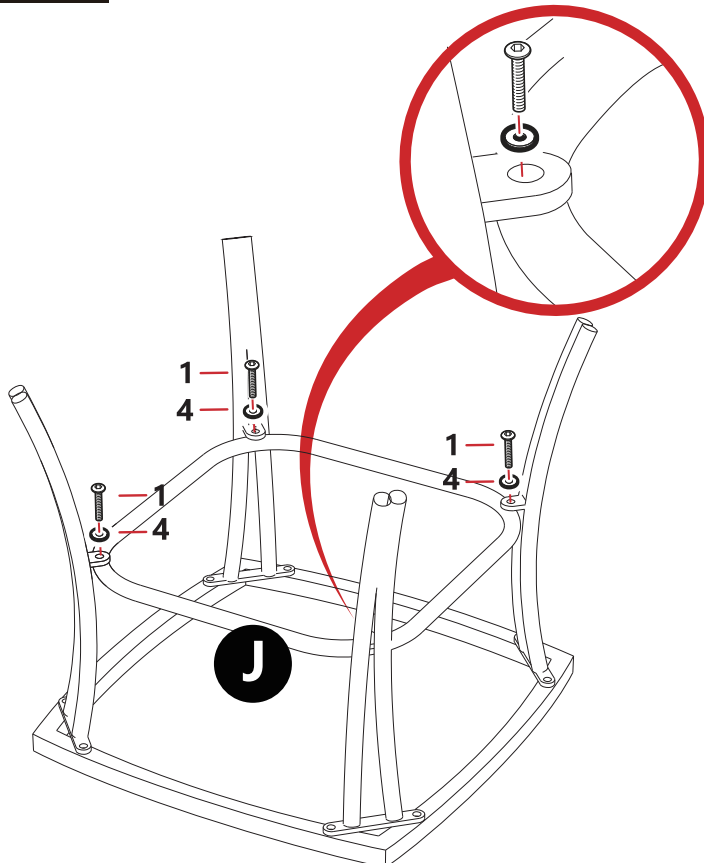

K		4 PC
I		1 PC
1		SCREW M6×15MM
4		8 PC
4		8 PC

PRODUCT ASSEMBLY - TABLE

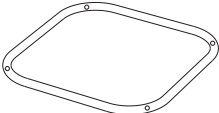
Step 2



J		1 PC
1		SCREW M6×15MM
4		4 PC
4		4 PC