

# Instruction Manual

33003A-2

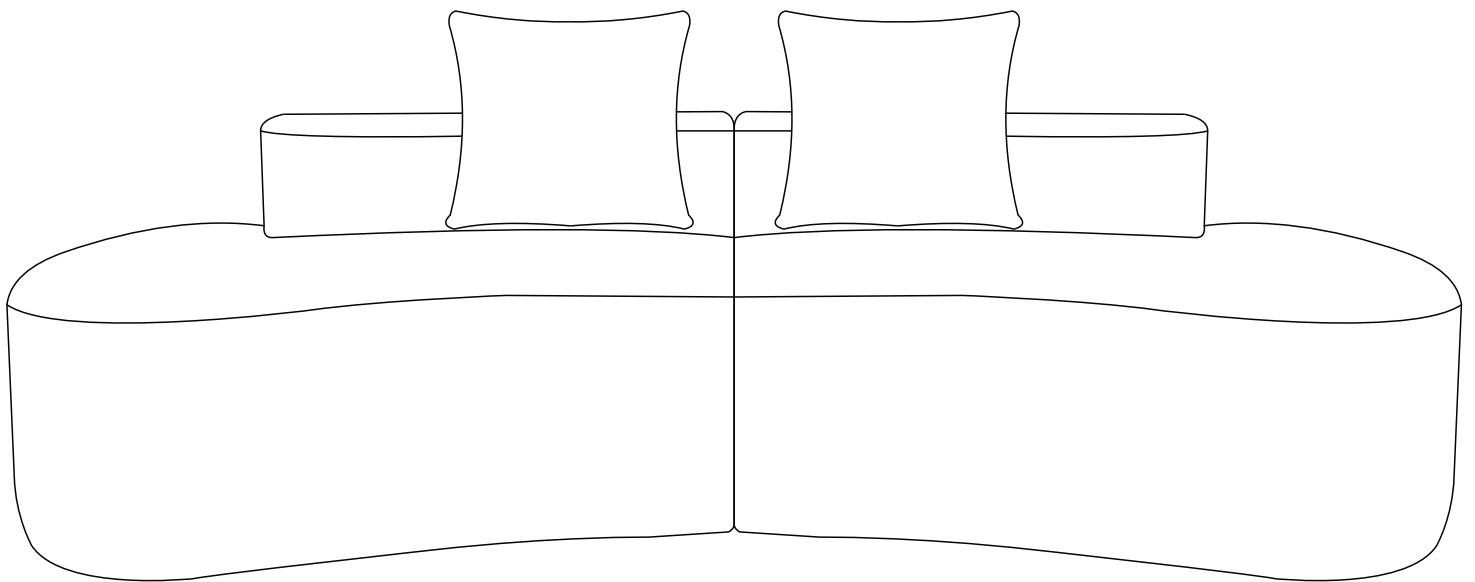

## PART LIST:

①. Compact sofa

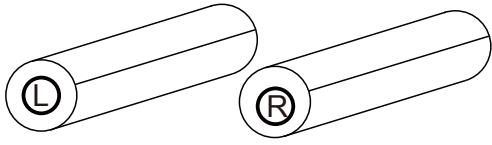

②. Membrane-cutting knife



③. Link key\*2

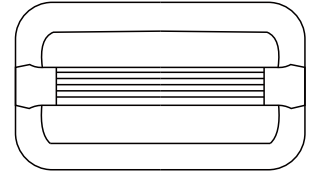

## INSTALLATION STEPS:

Step 1:

Use the membrane-cutting knife ② to cut through the first layer of the outer packaging film.

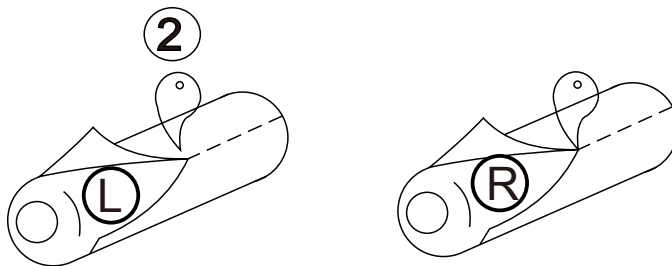

Step 2:

Lift the sofa flat and place it face up.

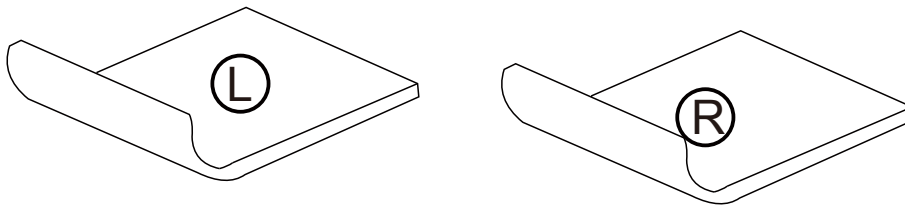

Step 3:

Use the membrane cutting knife ② to cut through the vacuum compression membrane

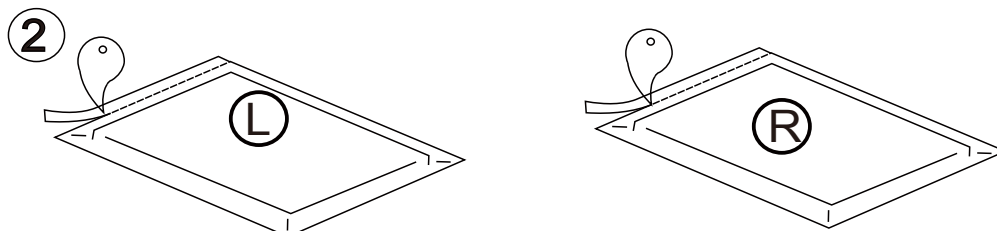

Step 4:  
Wait for the sofa to fully rebound.

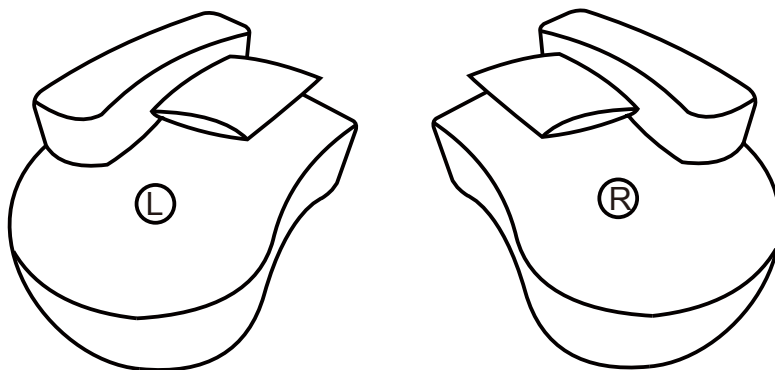

Step 5:  
Use the Velcro fasteners at the bottom to connect them with the Link key ③

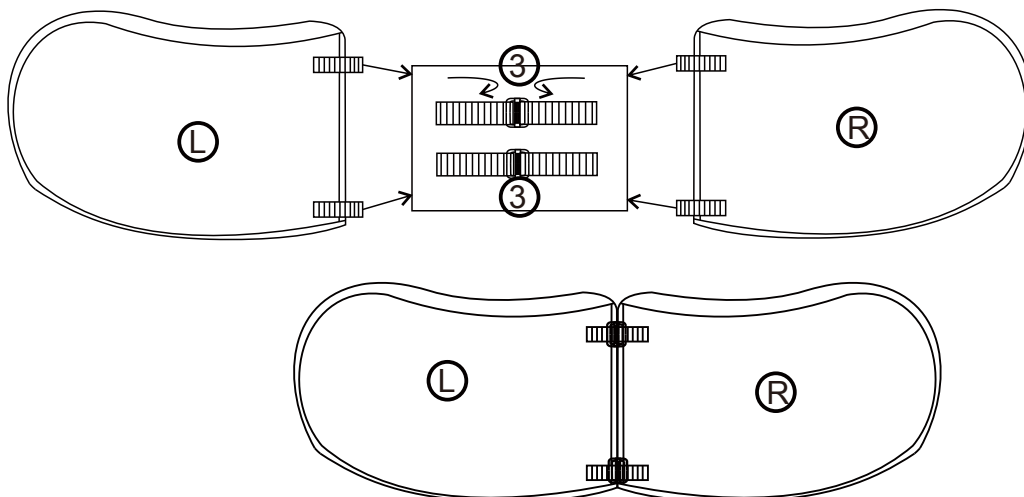

## Finished product schematic diagram

