

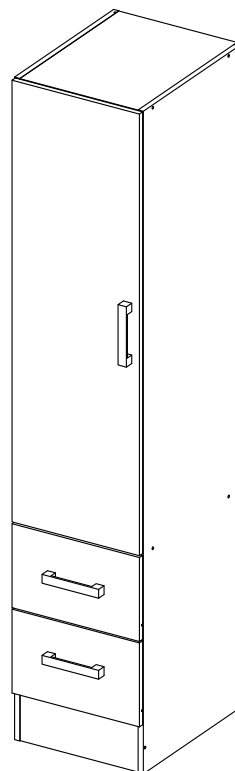

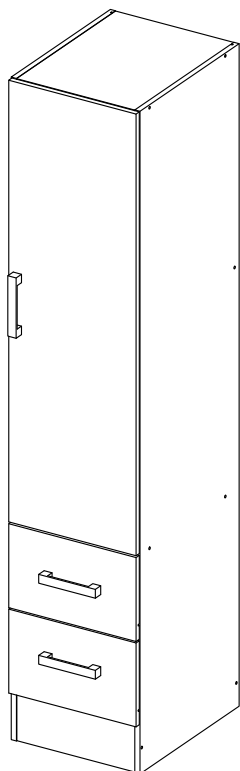





FURNITURE / INSTRUCTIONS

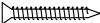
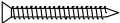
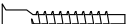

| HARDWARE LIST | | | QTY (pcs) |
|---------------|---|--------------------------------|--------------|
| A2 |  | Screw m3.5 x 14mm | 66 |
| A7 |  | Screw m4 x 30mm | 6 |
| A10 |  | Screw m4 x 38mm | 8 |
| A17 |  | Crosshead Screw m6.3 x 40mm | 14 |
| A34 |  | Euro Screw m5 x 8mm | 8 |
| A40 |  | TH Screw m4 x 10mm | 8 |
| D4 |  | Wood Dowel 6 x 25mm | 14 |
| E5 |  | Soft Closing Hinge 5/8 | 2 |
| E21 |  | Anti-Tipping Pack | 1 set |

| | | | |
|-----|--|------------------------------------|-----------|
| F2 |  | Mini Fix 15mm | 8 Sets |
| H21 |  | Handle 128mm | 3 |
| K2 |  | Magnet Catch_5KG | 1 |
| L2 |  | Plastic Leg L Shape | 4 |
| M19 |  | 2 Way Slide_406mm | 2 Sets |
| N1 |  | Allen Key | 1 |
| P |  | Hanging Steel Pipe 18mm x 354mm | 1 |
| R2 |  | Single Plastic Cap | 22 |
| Y |  | Crosshead Cover | 14 |

*** Extra screw for your commitment.**

*** Please assemble flat or nice service.**

MADE IN MALAYSIA

Page 1/22

"Congratulations on Your Recent Purchase! Here Are Some Tips Before You Begin Assembling:"

"Preparing for your exciting new purchase? Be sure to set yourself up for a smooth assembly process by following these steps:"

- First, we recommend using a rug or any large clean surface as your workspace to provide a sturdy base for assembly.
- Next, it is important to separate all components and identify each part by their designated letters. This will make it easier to follow the assembly instructions and ensure all pieces are placed correctly.
- Additionally, on a clean surface separate and identify all screws lengths and hardware. You can use the assembly instructions as a guide and place the screws on top of the actual size pictured. This will save you time and confusion during the assembly process.
- Finally, we highly encourage you to carefully read through the assembly instructions and start from step one. Follow each step diligently until your new purchase is fully assembled. However, if you have any questions or need further assistance, please do not hesitate to reach out to us via email.

**Thank you again for choosing our product.
We wish you all the best and happy assembling!**

FURNITURE / INSTRUCTIONS

Place your screw on top of the scale to identify their size.

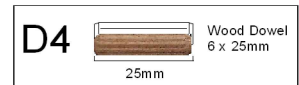
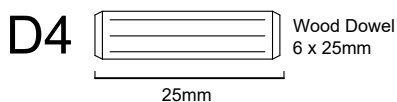
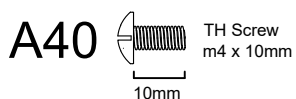
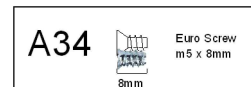
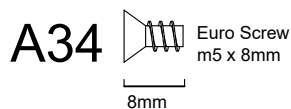
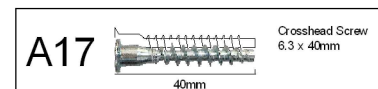
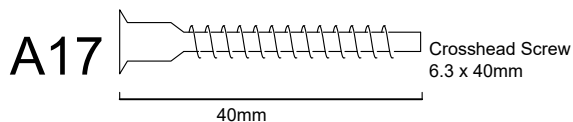
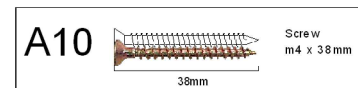
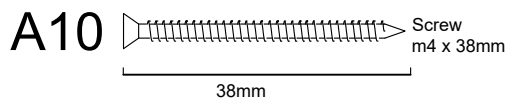
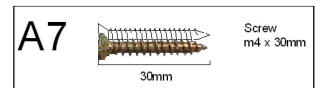
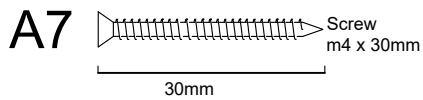
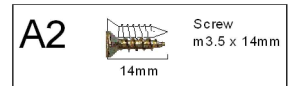
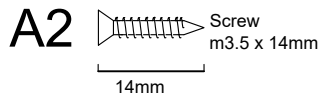

Reversible Door

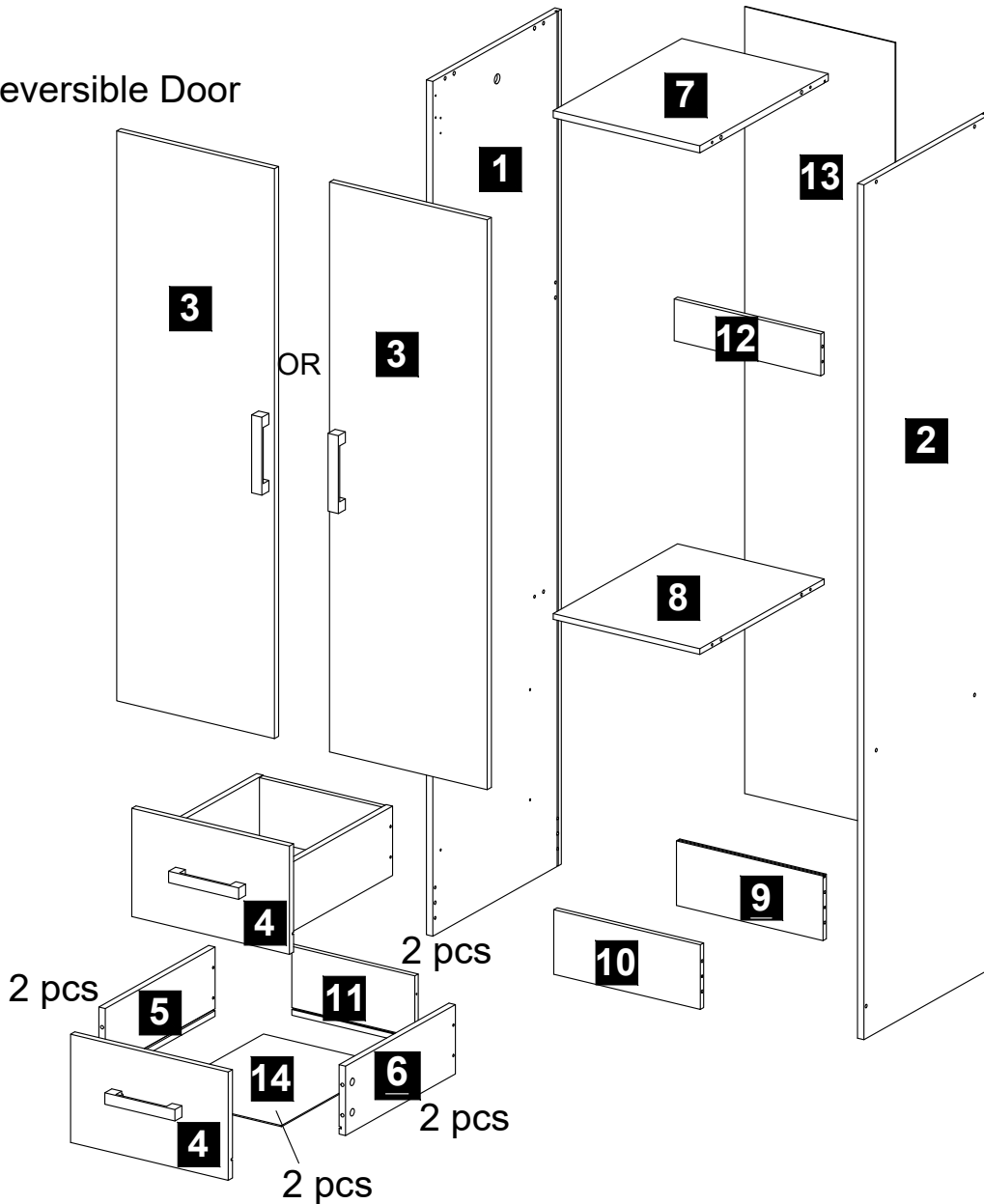

Parts List

| | | | | | |
|---|-----------------------|-------|----|---------------------|-------|
| 1 | Side Panel (L) | 1 pc | 8 | Base Panel | 1 pc |
| 2 | Side Panel (R) | 1 pc | 9 | Crossbar | 1 pc |
| 3 | Door Panel | 1 pc | 10 | Crossbar Panel | 1 pc |
| 4 | Drawer Front Panel | 2 pcs | 11 | Drawer Back Board | 2 pcs |
| 5 | Drawer Side Panel (L) | 2 pcs | 12 | Small Crossbar | 1 pc |
| 6 | Drawer Side Panel (R) | 2 pcs | 13 | Backboard | 1 pc |
| 7 | Top Panel | 1 pc | 14 | Drawer Bottom Panel | 2 pcs |

EACH PART IS LABELLED ACCORDING TO THE PARTS LIST



Before starting assembly
please verify if all parts and
hardware are included

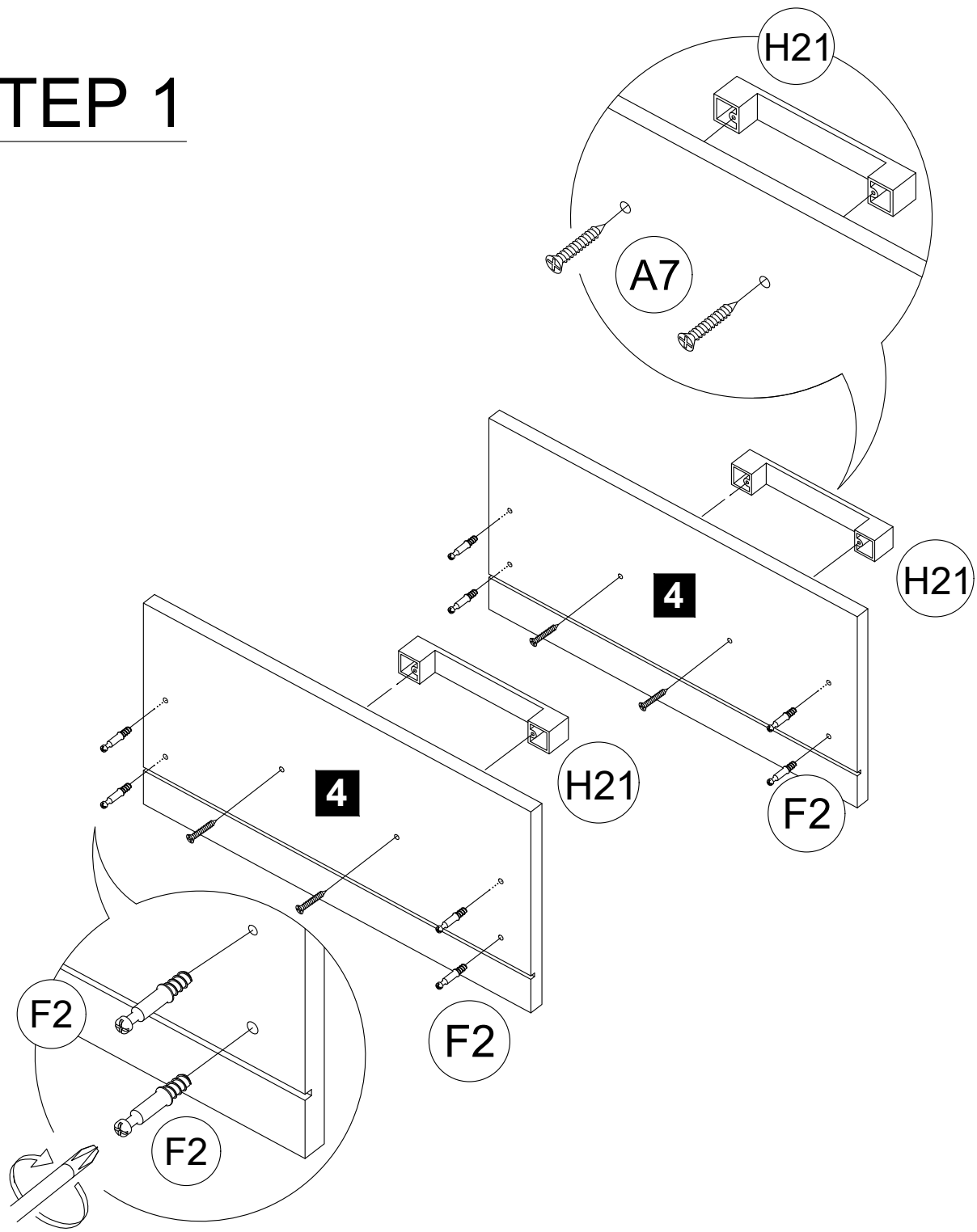

STEP 1

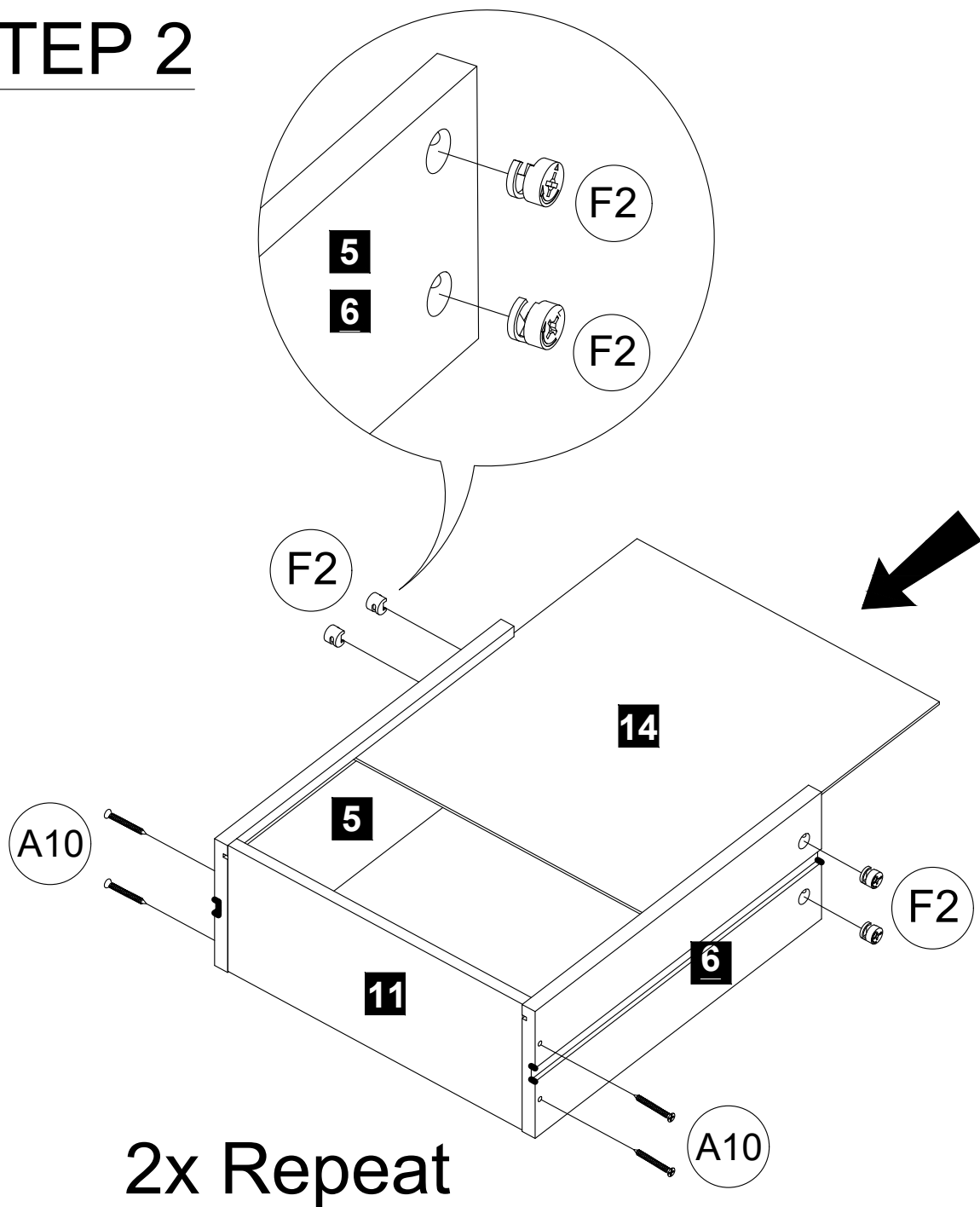

| | | | |
|-----|---|-----------------|-------|
| A7 |  | Screw m4 x 30mm | 4 pcs |
| F2 |  | Mini Fix Bolt | 8 pcs |
| H21 |  | Handle 128mm | 2 pcs |

STEP 2

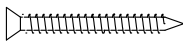

| | | | |
|-----|---|-----------------|-------|
| A10 |  | Screw m4 x 38mm | 8 pcs |
| F2 |  | Mini Fix Cam | 8 pcs |

STEP 3

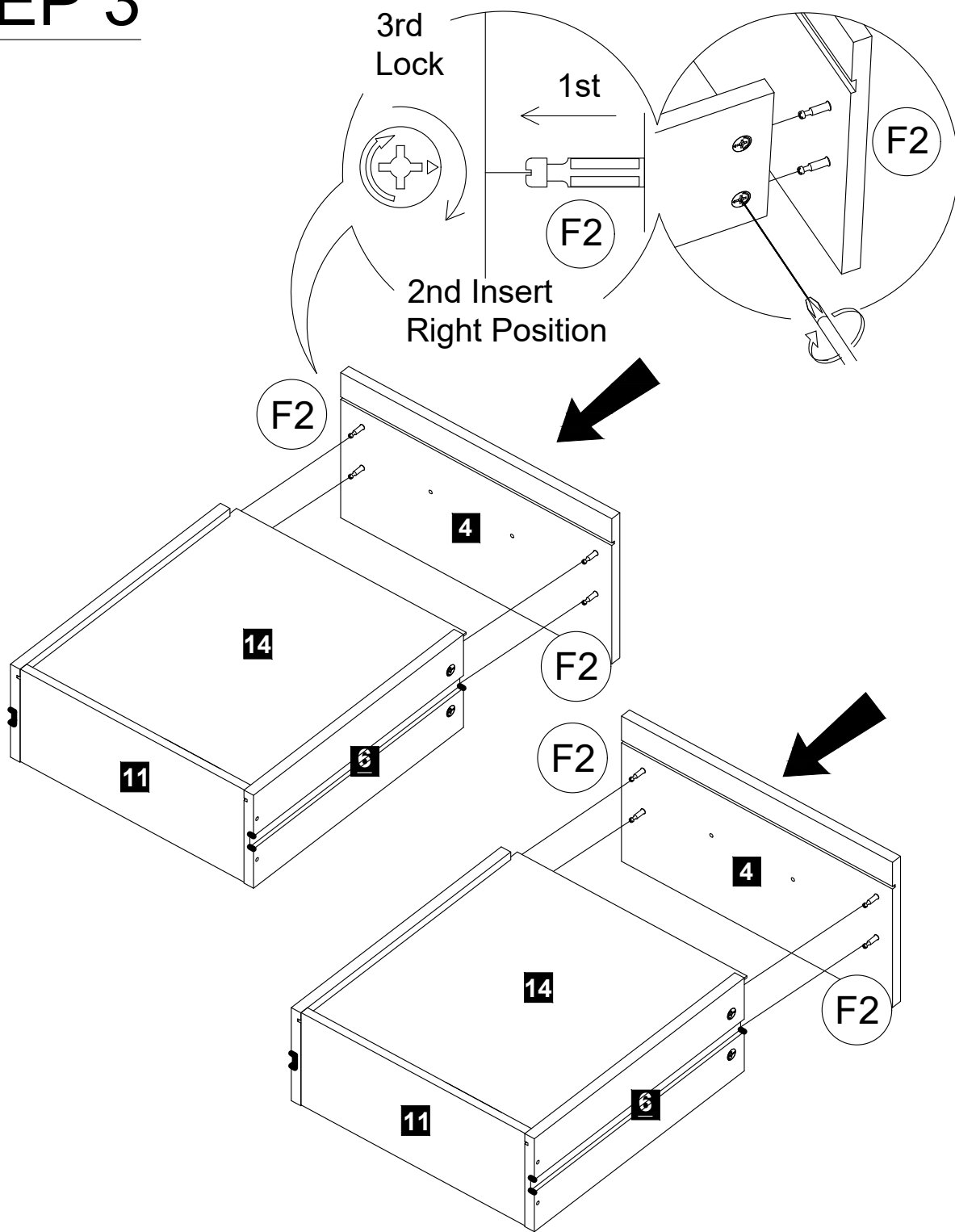

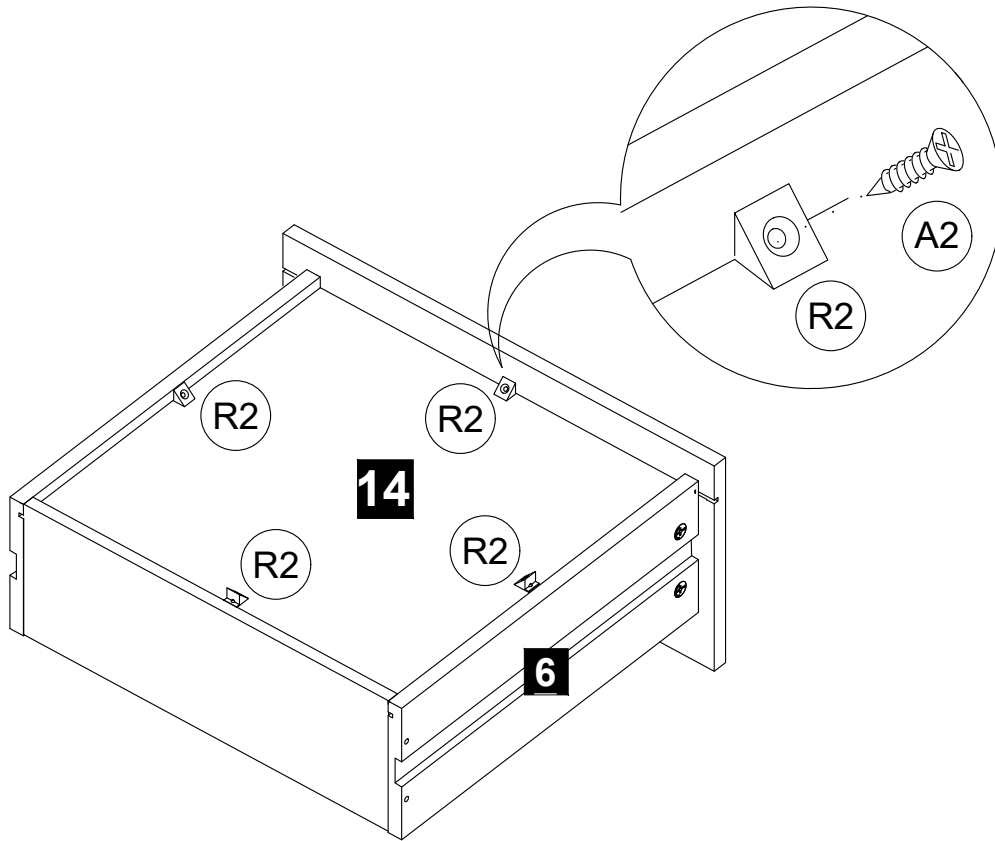

| | | | |
|----|---|---------------|--------|
| F2 |  | Mini Fix 15mm | 8 sets |
|----|---|---------------|--------|

STEP 4



2x Repeat

| | | | |
|----|---|--------------------|-------|
| A2 |  | Screw m3.5 x 14mm | 8 pcs |
| R2 |  | Single Plastic Cap | 8 pcs |

ATTENTION !

STEP 5

Assemble the panel on **clean surface** or rug

If door open **Left** , place **K2** at right of panel no **3**

If door open **Right** , place **K2** at left of panel no **3**

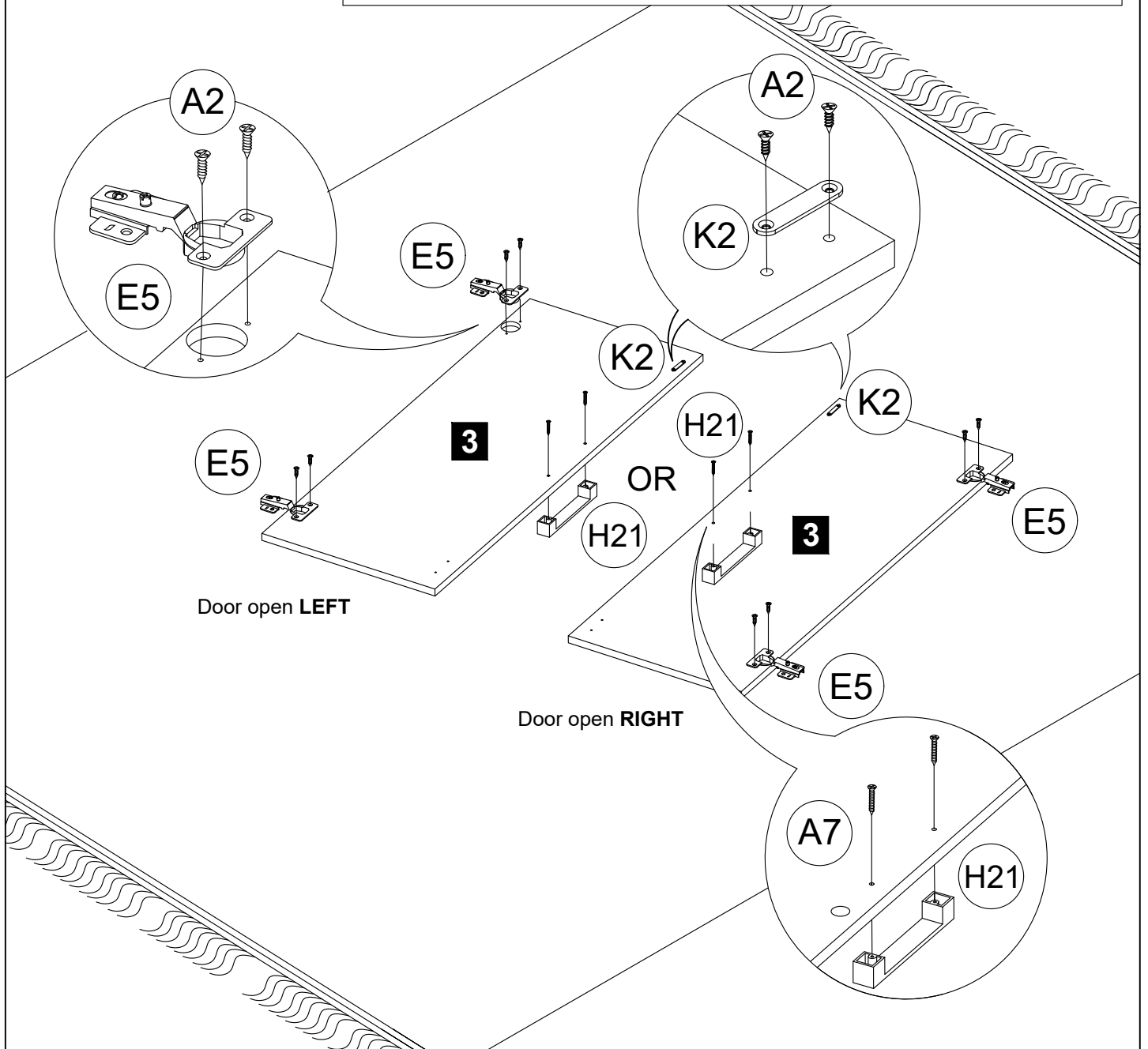

| | | | |
|-----|---|------------------------|-------|
| A2 |  | Screw m3.5 x 14mm | 6 pcs |
| A7 |  | Screw m4 x 30mm | 2 pcs |
| E5 |  | Soft Closing Hinge 5/8 | 2 pcs |
| H21 |  | Handle 128mm | 1 pcs |
| K2 |  | Magnet Catch_5kg | 1 pc |

STEP 6

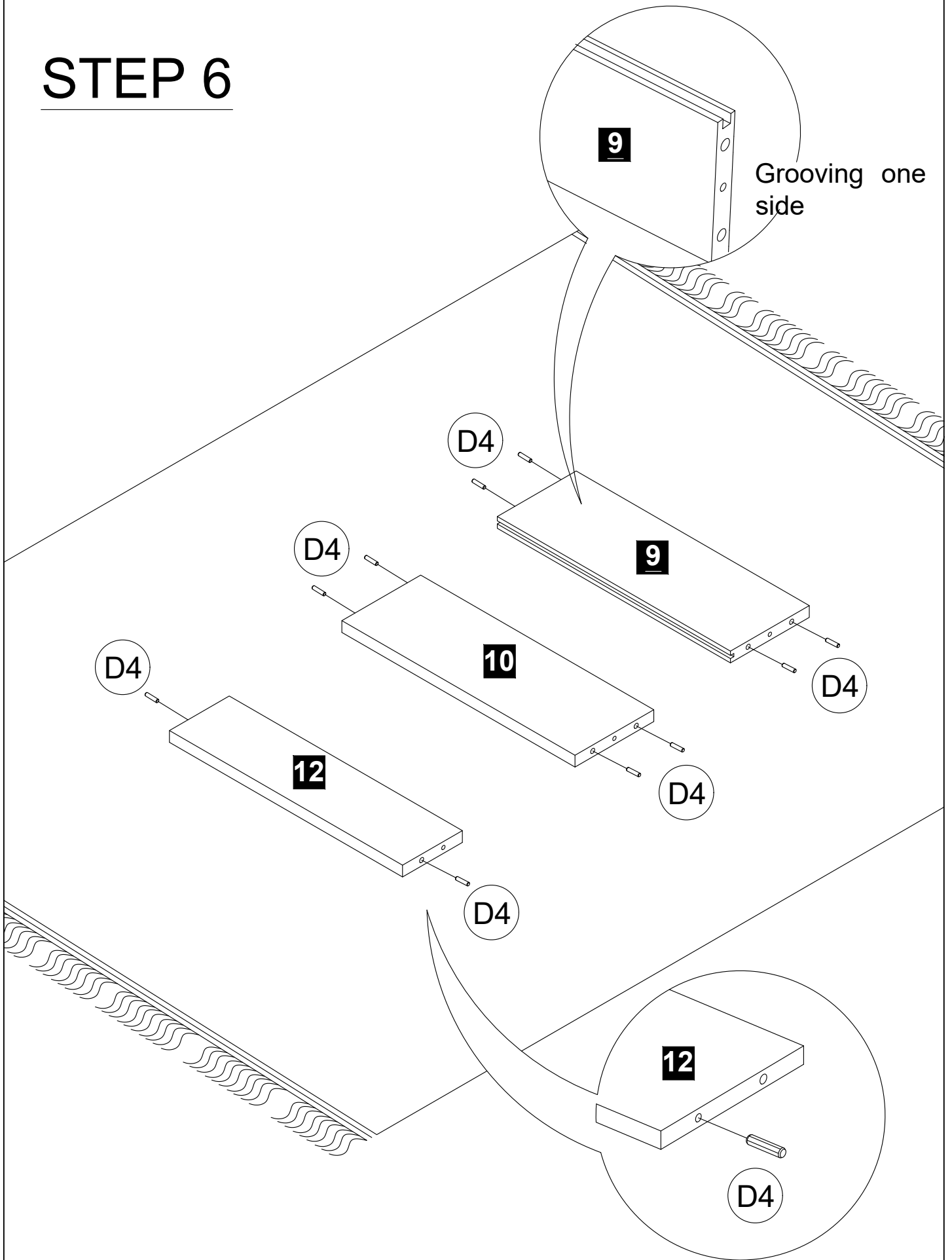

| | | | |
|----|---|---------------------|--------|
| D4 |  | Wood Dowel 6 x 25mm | 10 pcs |
|----|---|---------------------|--------|

STEP 7



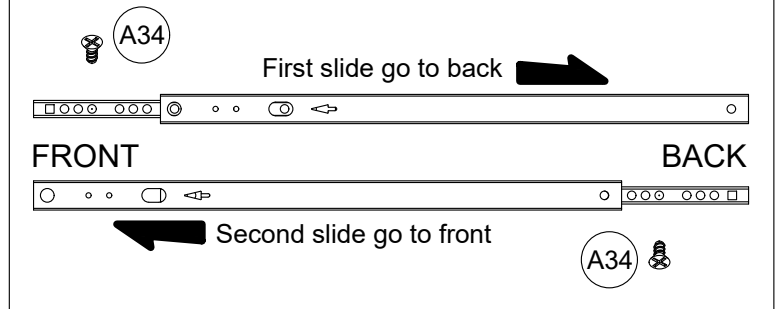

To Assemble the 2 Way Slide, Please follow step as below

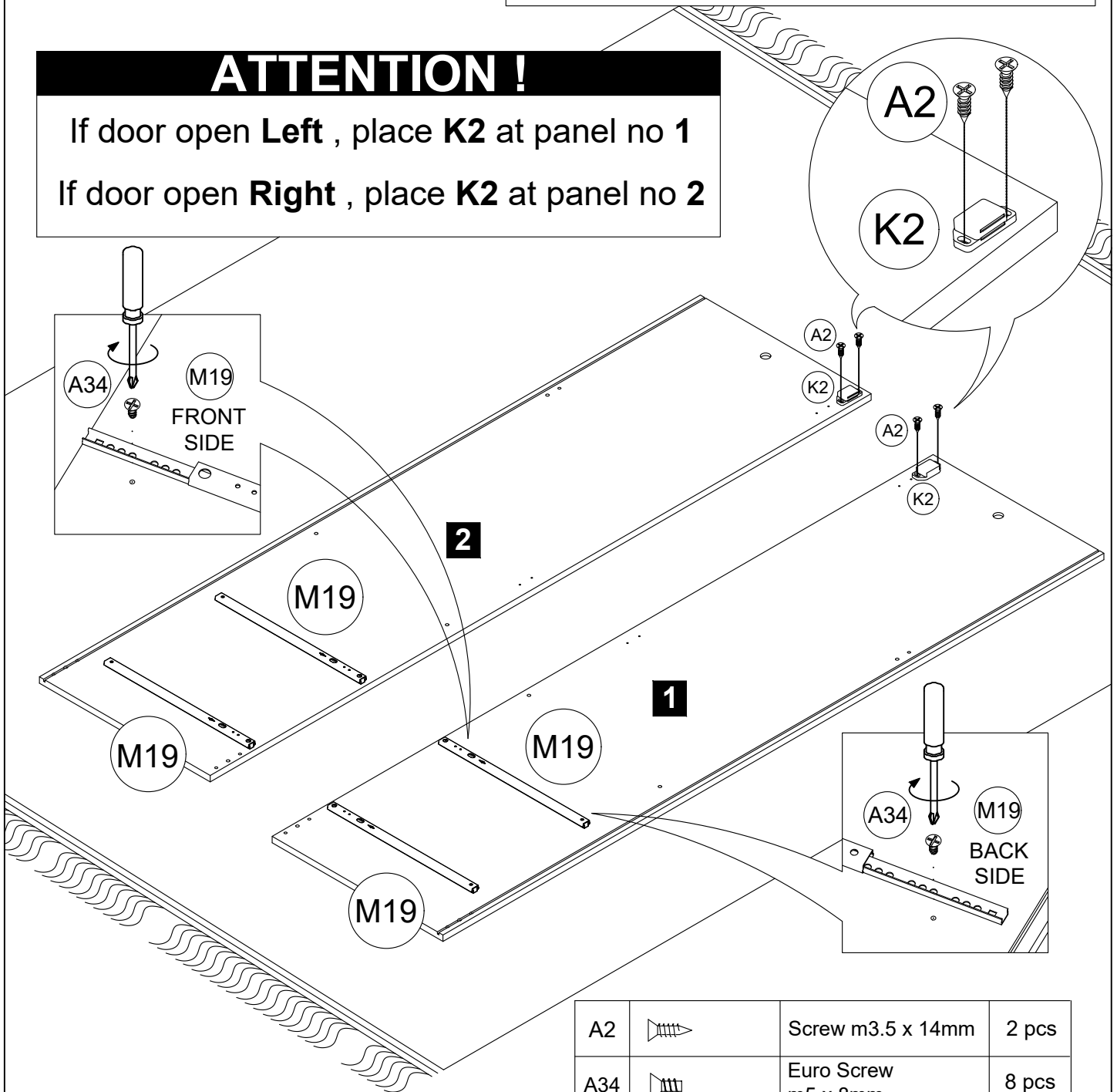

ATTENTION !



If door open **Left** , place **K2** at panel no **1**
 If door open **Right** , place **K2** at panel no **2**



| | | | |
|-----|--|---------------------|--------|
| A2 |  | Screw m3.5 x 14mm | 2 pcs |
| A34 |  | Euro Screw m5 x 8mm | 8 pcs |
| M19 |  | 2 Way Slide_406mm | 2 sets |
| K2 |  | Magnet Catch_5kg | 1 pc |

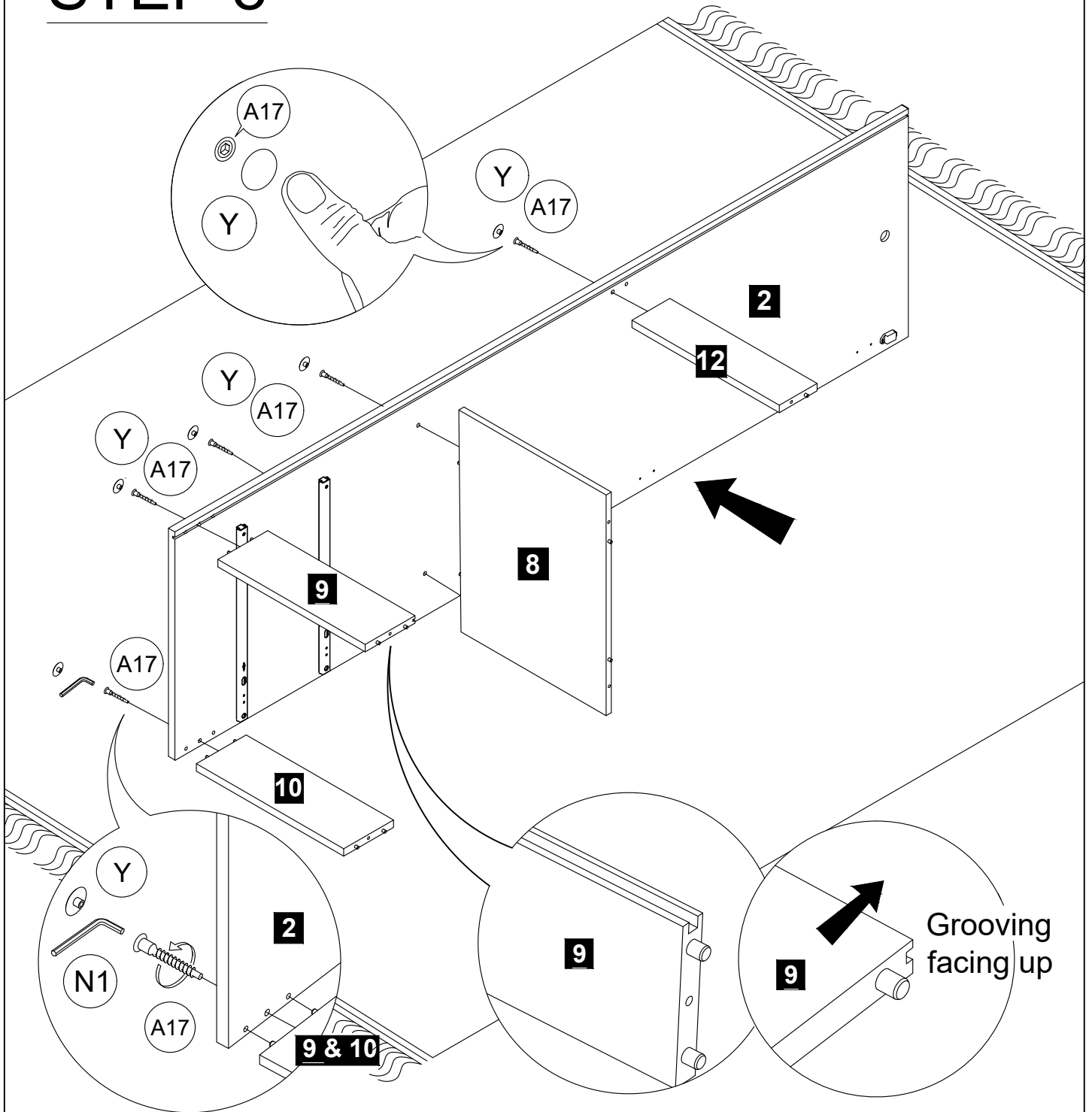

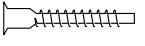

STEP 8

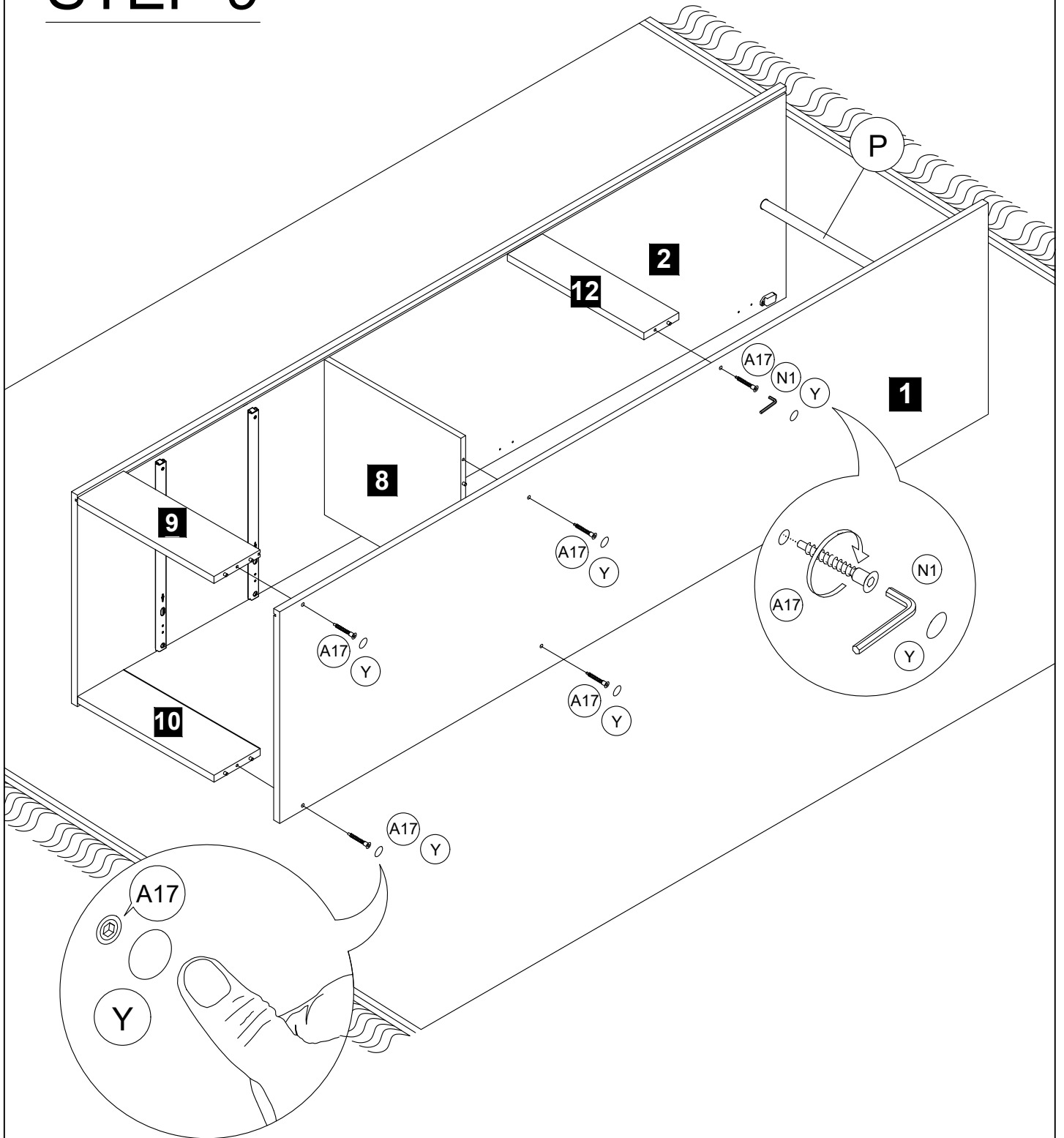

| | | | |
|-----|---|--------------------------------|-------|
| A17 |  | Crosshead Screw m6.3 x 40mm | 5 pcs |
| N1 |  | Allen Key | 1 pc |
| Y |  | Crosshead Cover | 5 pcs |

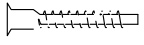
STEP 9

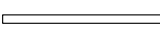

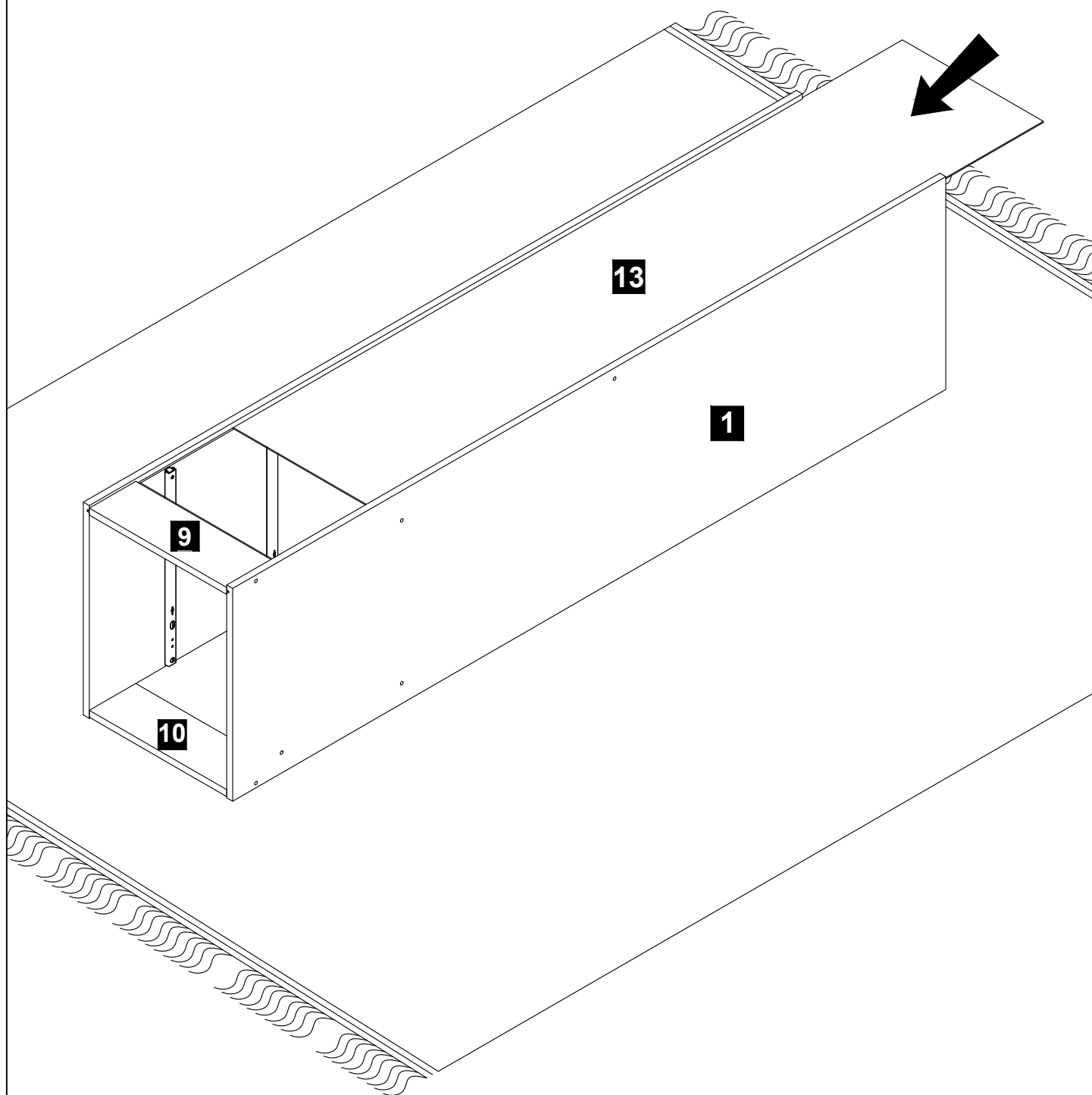

| | | | |
|-----|---|------------------------------------|-------|
| A17 |  | Crosshead Screw m6.3 x 40mm | 5 pcs |
| N1 |  | Allen Key | 1 pc |
| P |  | Hanging Steel Pipe 18mm x 354mm | 1 pc |
| Y |  | Crosshead Cover | 5 pcs |

STEP 10



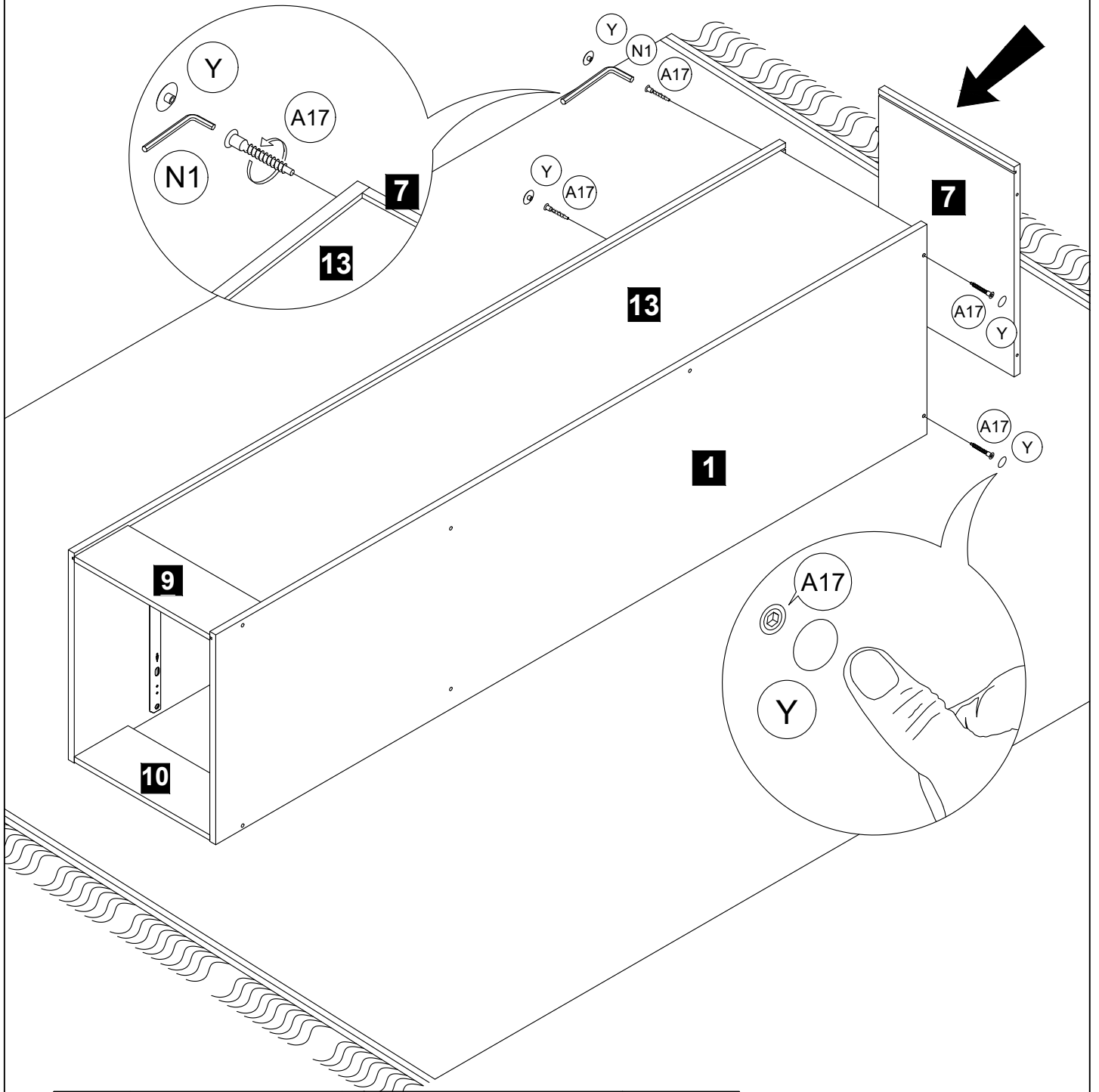

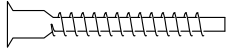

STEP 11

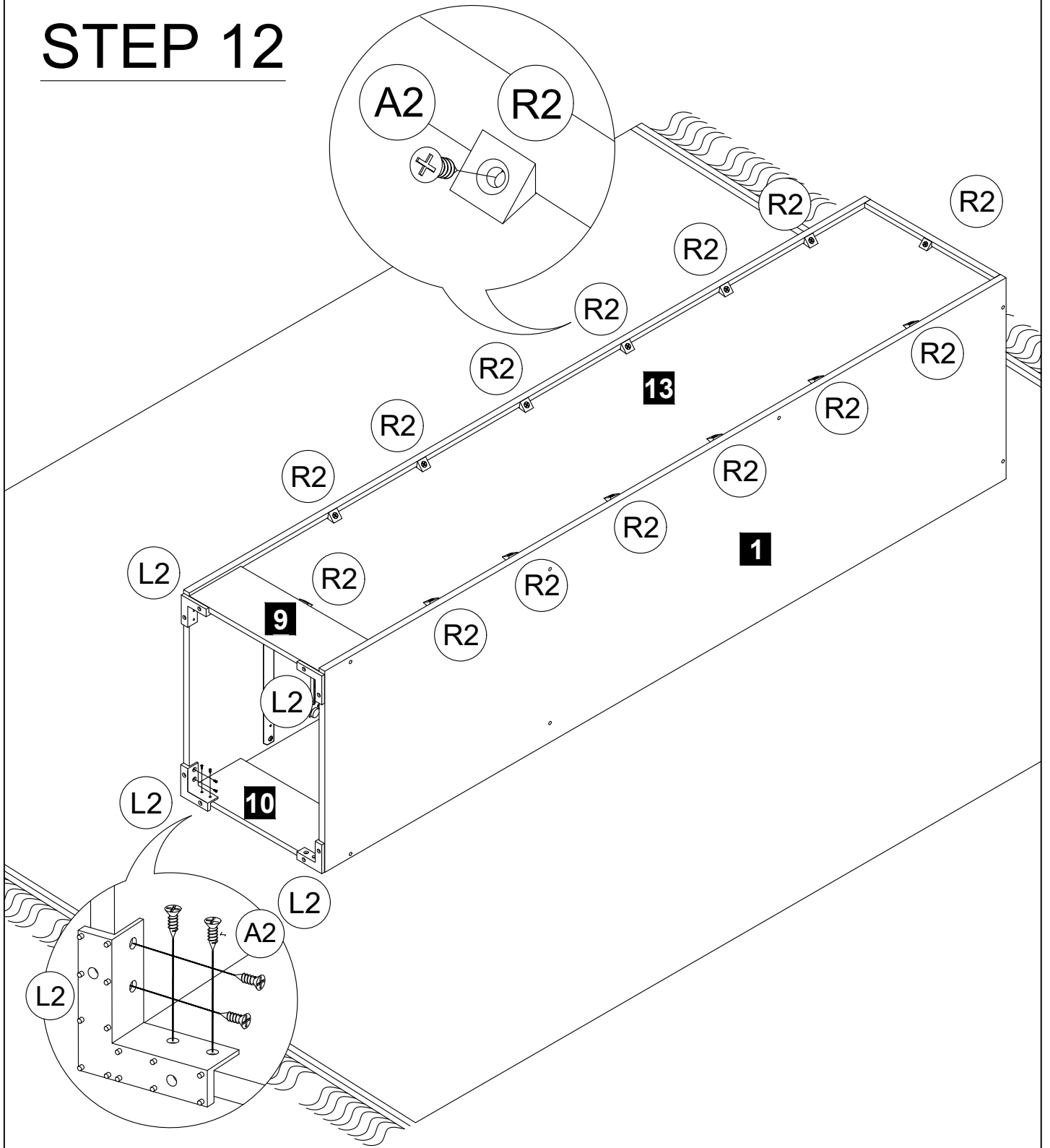

| | | | |
|-----|---|-------------------------------|-------|
| A17 |  | Crosshead Screw m6.3 x40mm | 4 pcs |
| N1 |  | Allen Key | 1 pc |
| Y |  | Crosshead Cover | 4 pcs |

STEP 12



| | | | |
|----|---|---------------------|--------|
| A2 |  | Screw m3.5 x 14mm | 30 pcs |
| L2 |  | Plastic Leg L Shape | 4 pcs |
| R2 |  | Single Plastic Cap | 14 pcs |

STEP 13

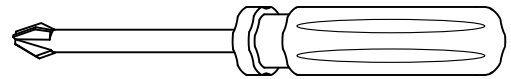

Please use Philips tip insert

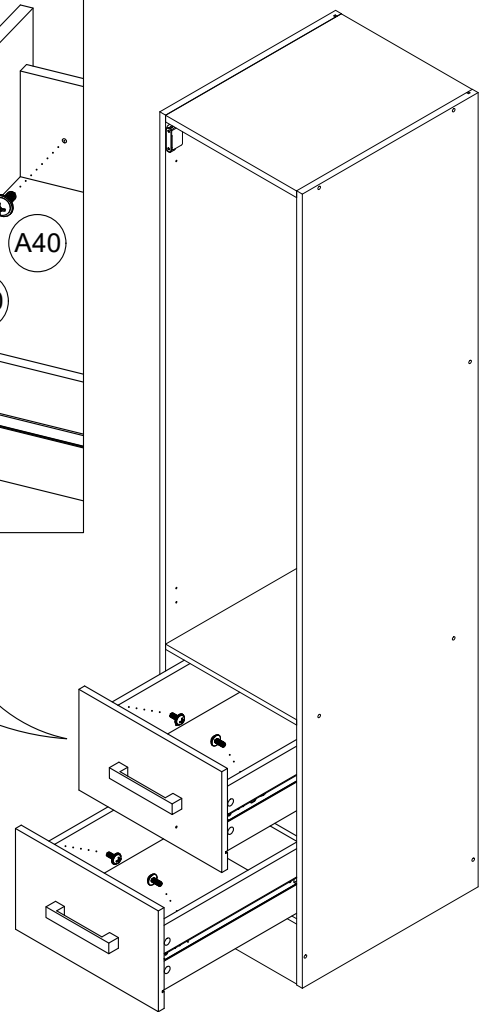
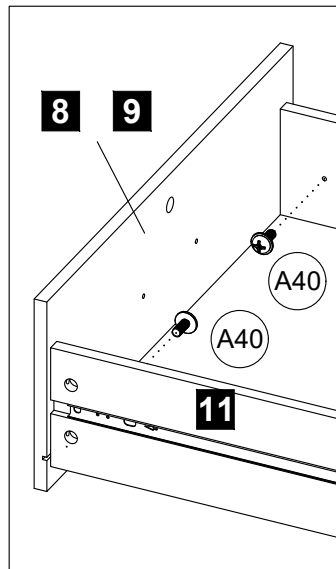
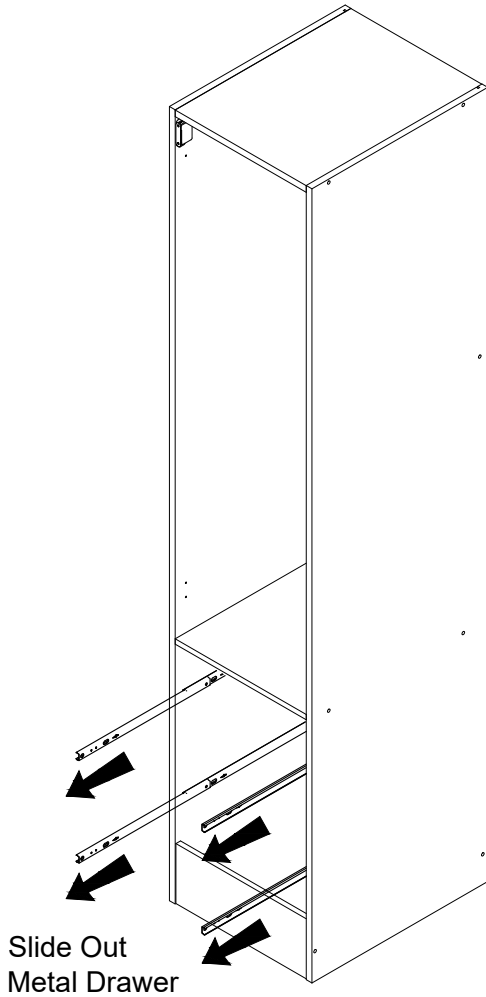

| | | | |
|-----|--|--------------------|---|
| A40 | | TH Screw m4 x 10mm | 8 |
|-----|--|--------------------|---|

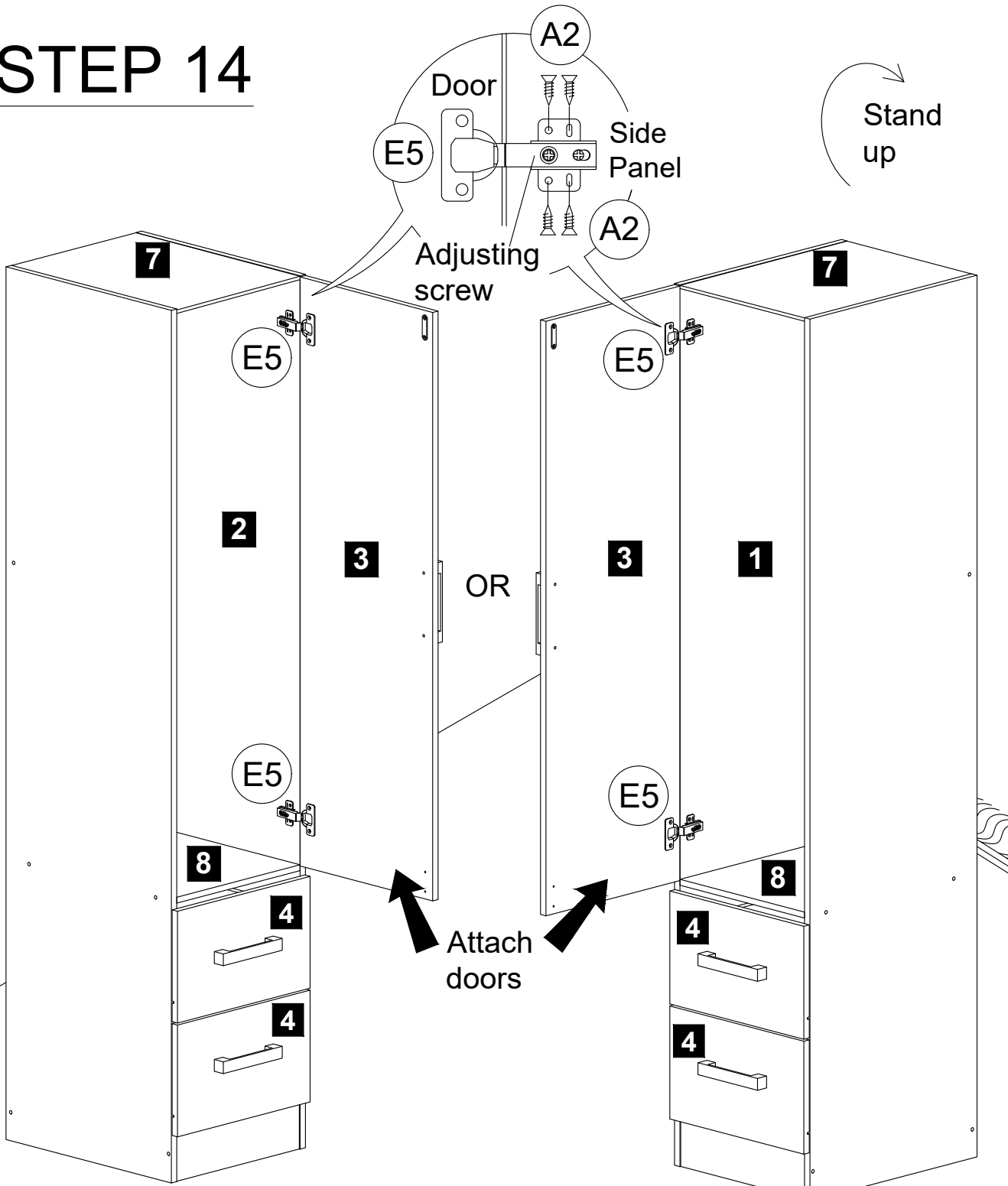

STEP 14

Stand up



Door open **LEFT**

Door open **RIGHT**

| | | | |
|----|---|------------------------|-------|
| A2 |  | Screw m3.5 x 14mm | 8 pcs |
| E5 |  | Soft Closing Hinge 5/8 | 2 pcs |

DOOR ADJUSTMENT

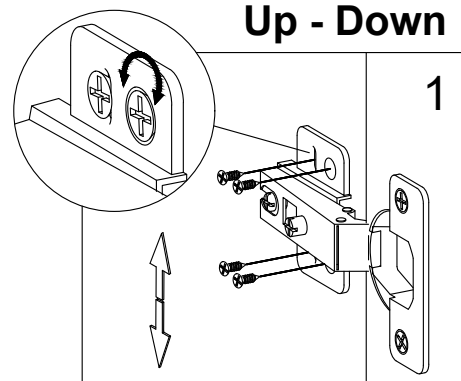
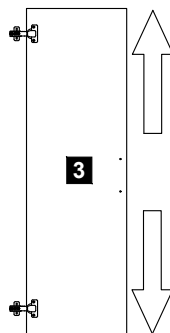
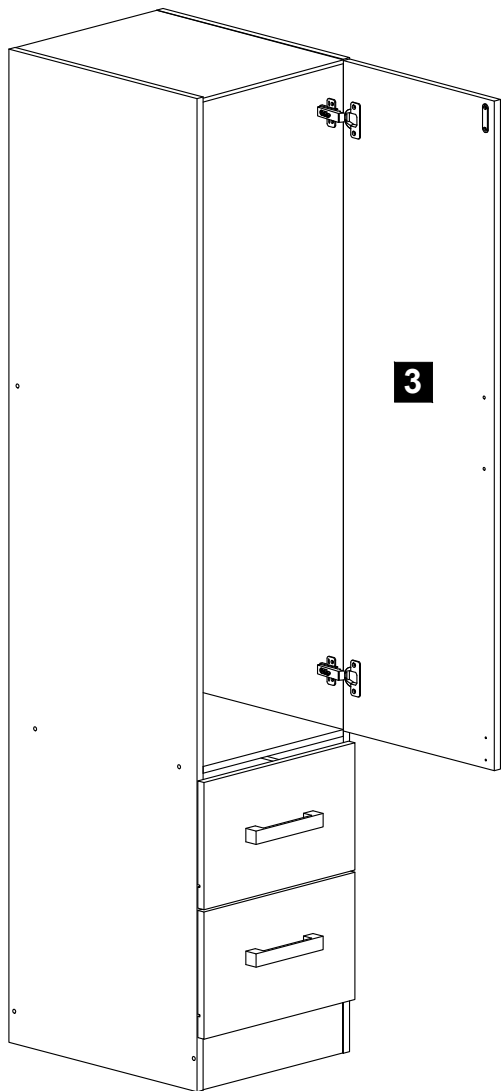

If the doors are not aligning move hinge up or down

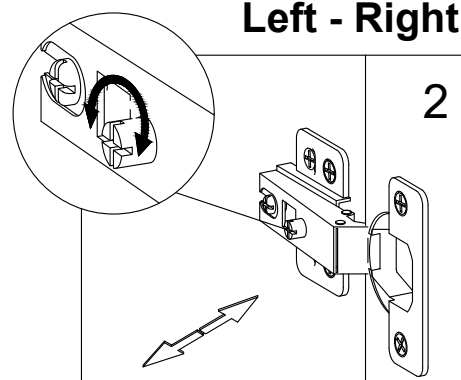
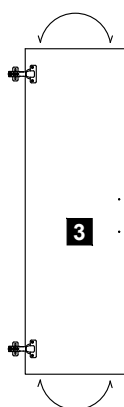

-If doors are over lapping each other or not parallel.
-If the gap between the doors is too large or too small.

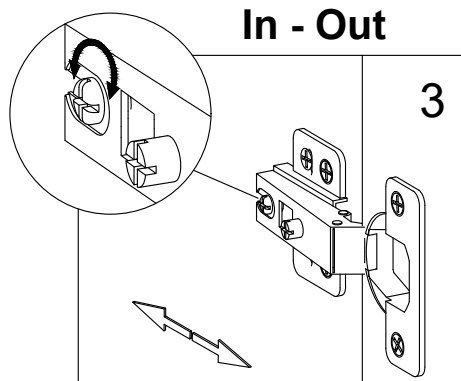
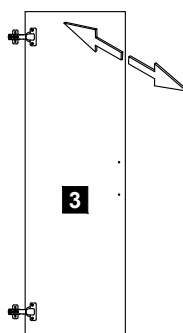

If the doors are rubbing against the sides of the closet move them away to increase the swing of the door.

INSTALLATION OF TIPOVER RESTRAINT KIT

The Tipover Restraint Kit is highly recommended for this piece of furniture.

(Please take this into extra consideration around young toddlers and children)

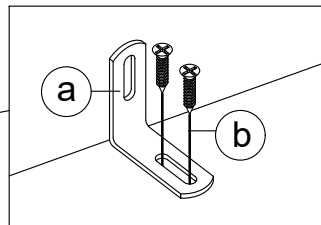
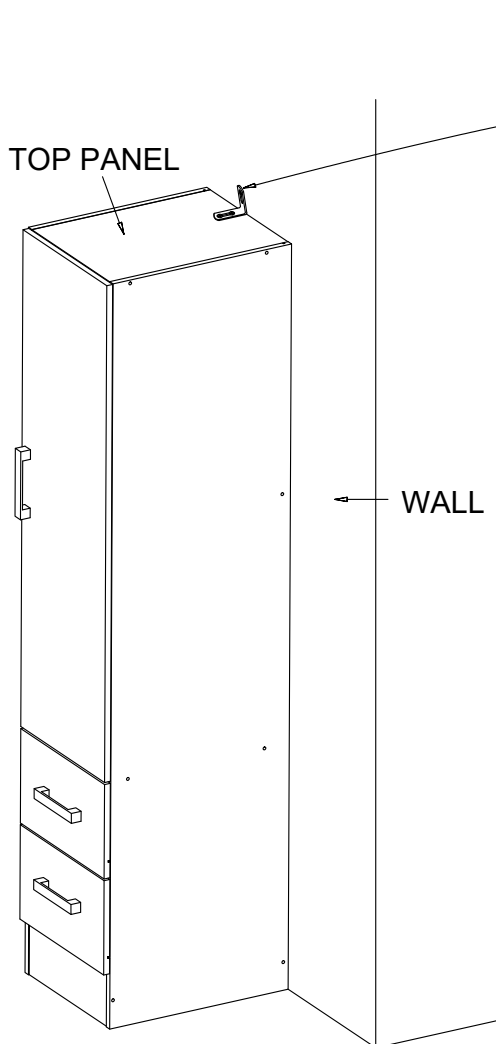

STEP 1:

- Attach the mounting bracket (a) to the the top panel near the edge of the side of the unit.
- Screw (b) through the two holes of (a).

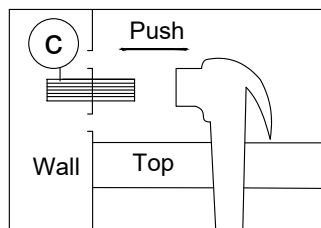

STEP 2:

- Insert the wall plug (d) into the wall behind the unit.

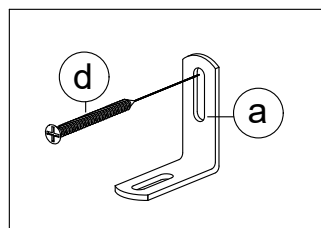

STEP 3:

- Attach to the mounting bracket (a) to the wall plug (c) through the hole by using (d).

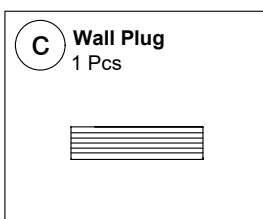
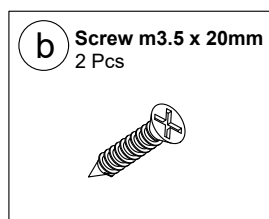
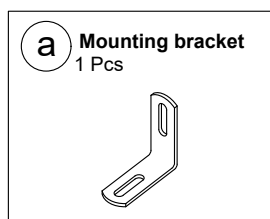

Troubleshooting

- If the drawers are overlapping each other - **Solution:** The metal slides are placed upside down, please refer to the instruction manual.
- If the doors are overlapping each other - **Solution:** make sure the correct hinges are placed on the right door refer to the hinge assembly step on the manual.
- If the gap between the doors is too large or too small, the doors are overlapping each other, not parallel, or rubbing against the sides of the closet - **Solution:** See the page for " Door Adjustment. "

THANK YOU

We hope you enjoy your new purchase.

We have personally inspected this product.

In the event that you need any additional help for any reason,