





























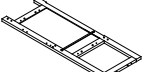
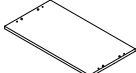



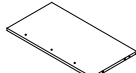

USER'S MANUAL

Storage Cabinet

PART LIST ASSEMBLY OVERVIEW

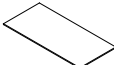
A	 6*35mm	x 20	G	 3*12mm	x 19	M		x 2
B	 15*10mm	x 20	H		x 1	N		x 1
C	 8*30mm	x 26	I		x 2	O		x 1
D	 4*12mm	x 1	J	 2.5*12mm	x 14	P	 3.5*40mm	x 1
E	 4*35mm	x 17	K		x 4	Q		x 1
F	 3*14mm	x 2	L	 4*18mm	x 2	R	 8*50mm	x 4

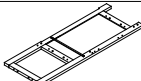
Parts List

1		x 1	11		x 1
2		x 1	12		x 1
3		x 1	13		x 1
4		x 1	14		x 1
5		x 1	15		x 1
6		x 1	16		x 1
7		x 2	17		x 1
8		x 1	18		x 1
9		x 1	19		x 2
10		x 1	20		x 1

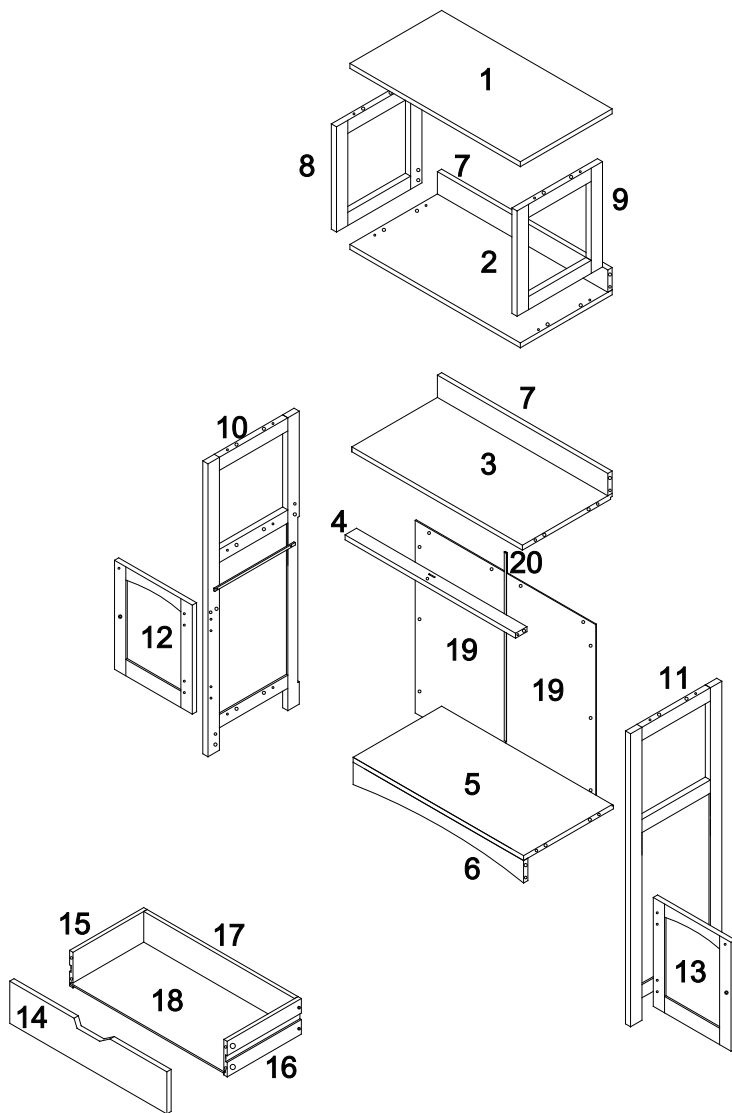

Step 1

A		x20
---	---	-----

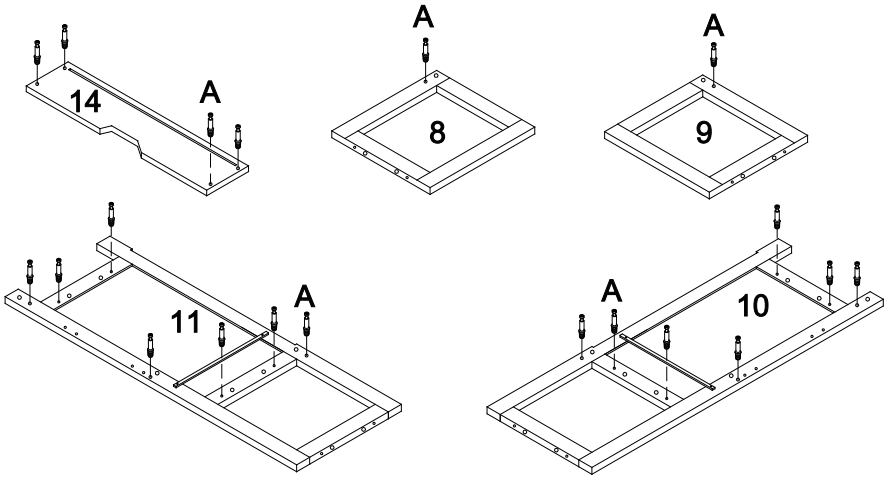





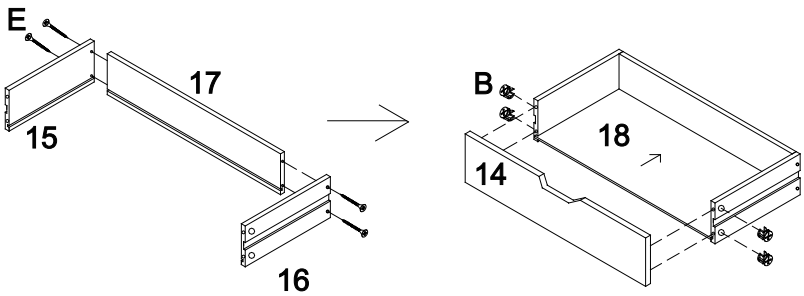

Step 3

B		x4
E		x4



Step 2

C		x2
D		x1
E		x1
G		x1
N		x1
O		x1

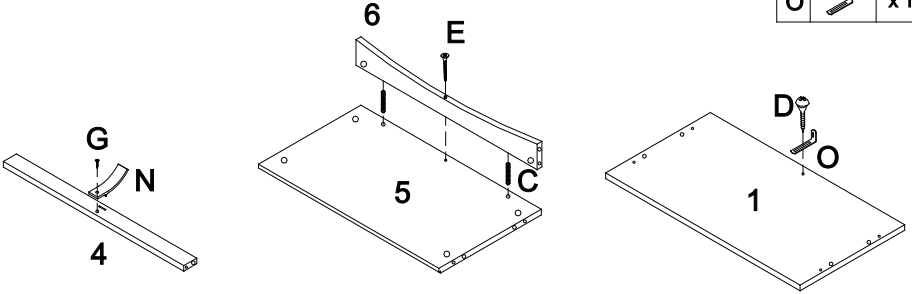

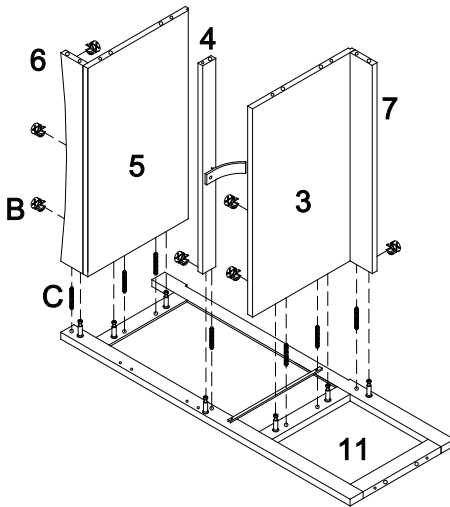

Step 4

B		x7
C		x7



Step 5

B		x7
C		x7

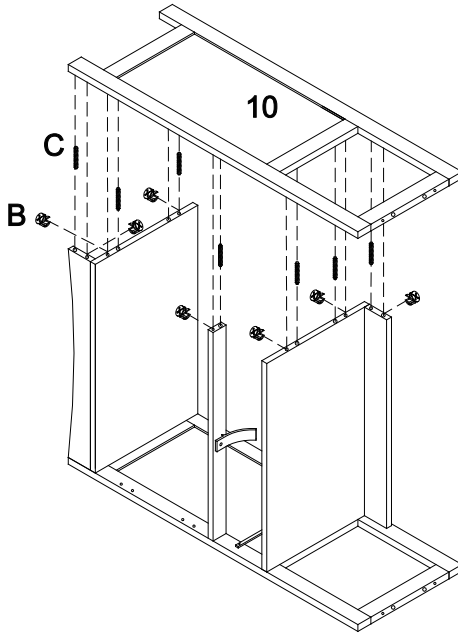

Step 6

B		x1
C		x1

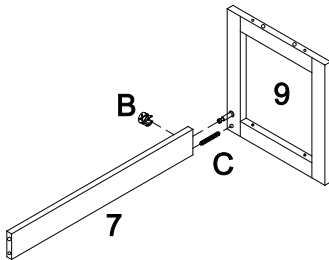

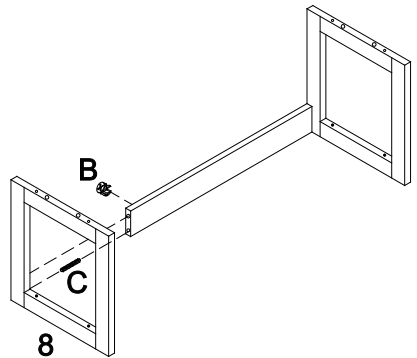

Step 7

B		x1
C		x1



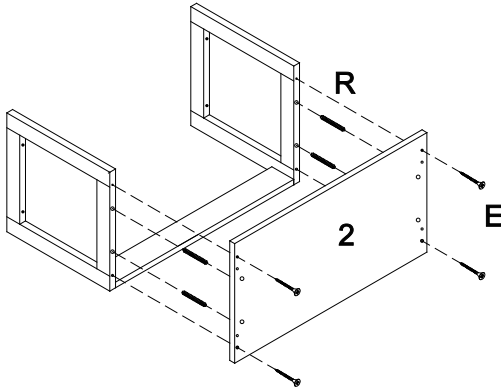

Step 8 / Schritt 8 / Étape 8 / PASO 8 / Passo 8 / Krok 8

E		x4
R		x4



Step 9

C		x8
E		x4

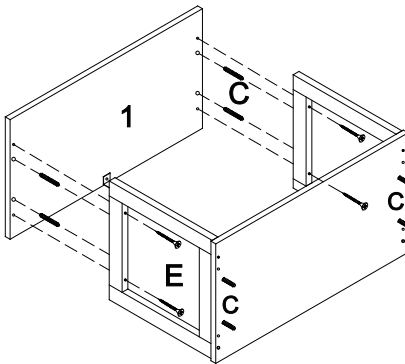

Step 10

E		x 4
---	---	-----

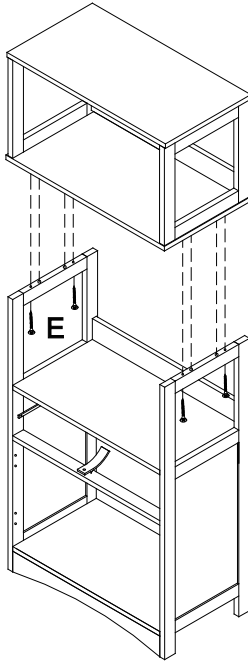

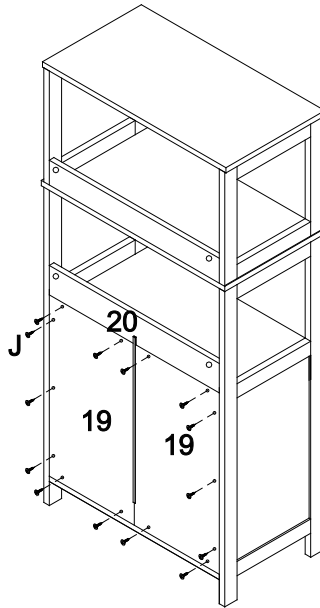

Ste 11

J		x 14
---	---	------





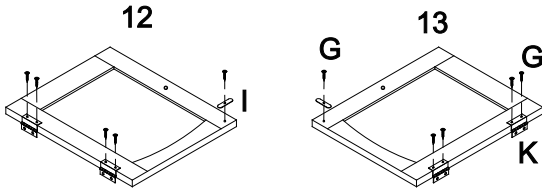

Step 12

G		x 10
I		x 2
K		x 4



Step 13

F		x 2
G		x 8
H		x 1
L		x 2
M		x 2

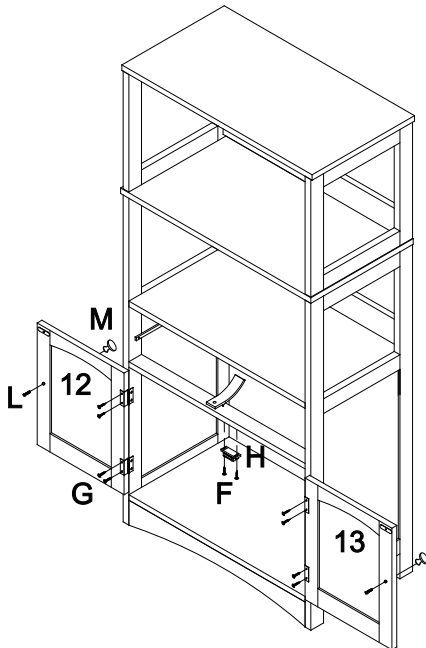

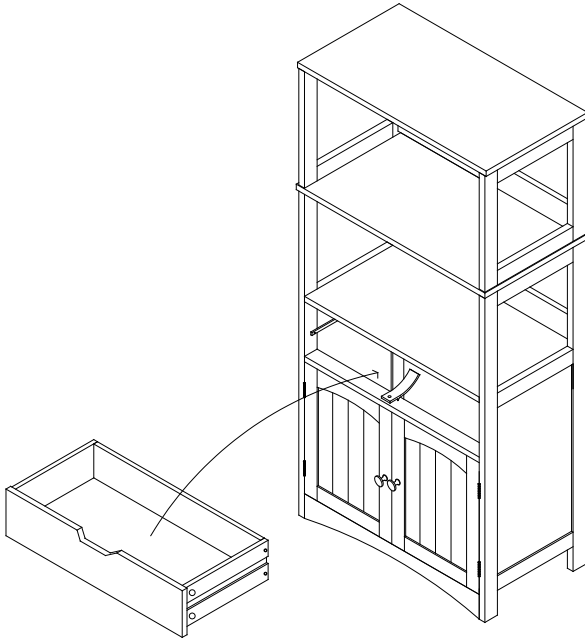

Step 14

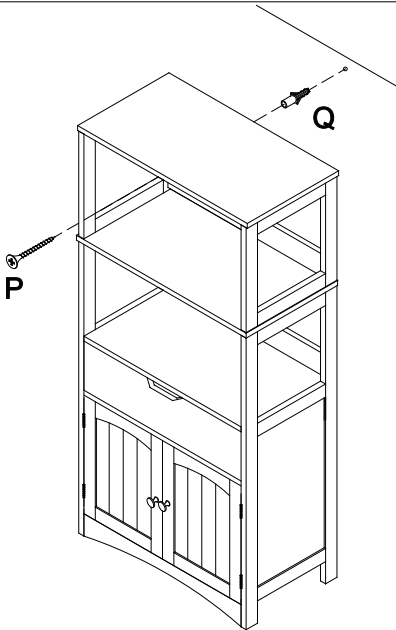

Step 15



P		x 1
Q		x 1