

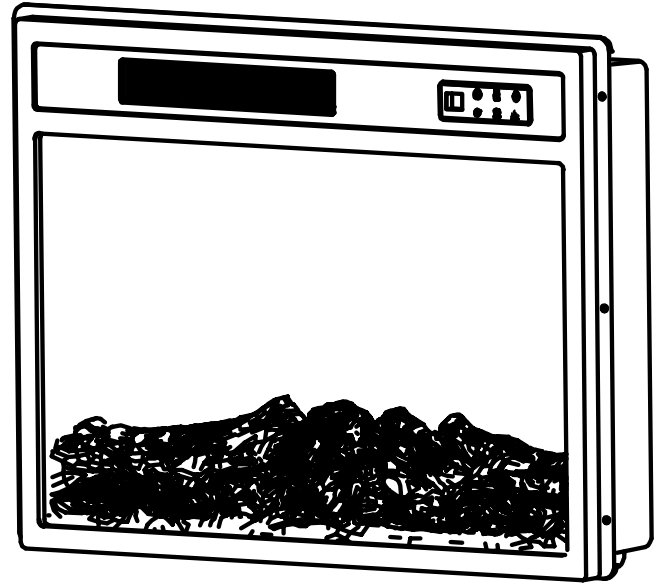

INSTRUCTION MANUAL

HMFP-001-BK



WELCOME TO THE FUTURE OF HOME ENTERTAINMENT!

Thank you for choosing our new electric fireplace and TV stands! Our products are designed to be both stylish and functional, with a focus on energy efficiency and sustainability.

We use high-quality materials to ensure that our pieces are built last, so you can enjoy them for years. Whether you're looking for a cozy electric fireplace or a stylish TV stand, we have something for everyone.

Our products are perfect for any home or office, and we're confident that you'll love them as much as we do!

IMPORTANT SAFETY INSTRUCTIONS. **READ** ENTIRE MANUAL PRIOR TO USE.

YEA, THE BORING STUFF

...but read it, so you don't jack things up!

PLEASE READ ALL OF THE INFORMATION IN THIS OPERATING MANUAL, INCLUDING ALL SAFETY OPERATING, AND MAINTENANCE INFORMATION. TO AVOID THE POTENTIAL RISK OF FIRE, ELECTRIC SHOCK, OR INJURY TO PERSONS, USERS SHOULD FOLLOW THE DIRECTIONS AND WARNINGS IN THIS MANUAL

1. Read all instructions before using this heater.
2. Do not use this heater outdoors.
3. This heater is not intended for use in bathrooms, laundry areas and similar indoor locations. Never locate the heater where it may fall into a bathtub or other water container.
4. Do not run the power cord under carpeting. Do not cover the power cord with throw rugs, runners, or the like. Arrange the power cord away from traffic areas and where it will not be tripped over.
5. To disconnect the heater, turn controls to off, then remove the plug from the outlet
6. Connect to properly grounded outlets only. Always plug heaters directly into a wall outlet/receptacle. Never use with an extension cord or relocatable power tap (outlet/power strip).
7. To prevent a possible fire, do not block firebox air intakes or the exhaust in any manner. Do not operate the firebox on soft surfaces, like a bed, where openings may become blocked.
8. There is a thermostat limiter inside the heater. When the inner temperature over heats or abnormal heating occurs, the thermostat protective device cuts off the power supply to avoid fireplace damaged or risk of fire.
9. Use this heater only as described in this manual. Any other use not recommended by the manufacturer may cause fire. electrical shock, or injury to persons.

SAVE THESE INSTRUCTIONS

⚠ WARNING:

There are no user serviceable parts inside the fireplace/heater, If the unit appears to malfunction, turn the unit off and unplug the unit from the wall immediately, and contact Customer.

⚠ WARNING:

This heater is hot when in use. To avoid burns, do not let bare skin touch hot surfaces. If provided, use handles when moving this heater. Keep combustible material, such as furniture pillows, bedding, papers, clothes and curtains at least 3 f.t.(0.9 meters) from the front of the heater and keep them away from the sides and rear.

⚠ WARNING:

Extreme caution is necessary when any heater is used by or near children or invalids and whenever the heater is left operating and unattended.

⚠ WARNING:

Always unplug the heater when not in use.

⚠ WARNING:

Do not operate any heater with a damaged cord or plug or after the heater malfunctions, has been dropped or damaged in any manner. Return the heater to an authorized service facility for examination, electrical or mechanical adjustment, or repair.

⚠ WARNING:

Do not insert or allow foreign objects to enter any ventilation or exhaust openings as this may cause an electric shock or fire, or damage the heater.

SAVE THESE INSTRUCTIONS

WARNING:

A heater has hot and arching or sparking parts inside. Do not use in areas where gasoline, paint, or flammable liquids are used or stored.

CAUTION:

While the heater is in use the top center of the fireplace can get hot to the touch, and may cause serious injury or burns. Always supervise small children around the fireplace/heater. Do not place any cloth or decorations over the heater outlet of the fireplace or otherwise obstruct the heater outlet of the fireplace, as this may cause a fire and serious injury may result.

After sale service

 1. Contact us via our email: patiochicservice@outlook.com

 2. Contact us via our phone: +1 888-572-2312

Working Time: Monday to Friday: EST (Eastern Standard Time) 9am-12am,
1pm-6pm

 3. Go to Your Orders Click "Contact Seller" to describe the issue.

WARRANTY

We are confident that you will be delighted with this purchase. Should this product be defective in workmanship or materials, or fail under normal use, we will repair or replace it for a period of up to one (1) year from the date of purchase.

This warranty gives you specific rights and you may also have other rights which vary from state to state.

PRE-INSTALLATION

ELECTRICAL SPECIFICATIONS

Voltage: 120VAC50HZ

Watts: 750W.1500W

GRAB YOUR TOOLS



Phillips Screwdriver

WHAT'S IN THE BOX

Screw A

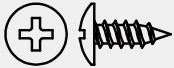

Size:M4x12

6+2 PCS

PARTS

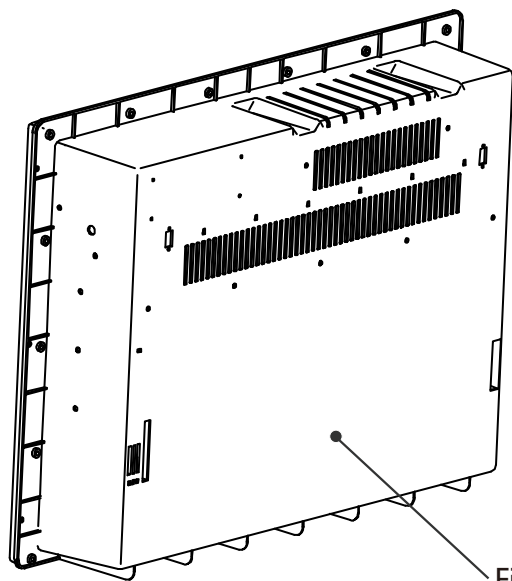

Fireplace Insert

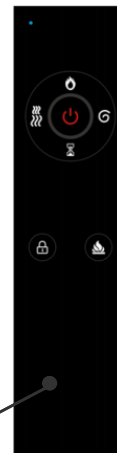

Remote Control

⚠ CAUTION:

This insert has front panel made of GLASS! ALWAYS use extreme caution when handling glass. Failure to do so could result in personal injury or property damage.

DIMENSION

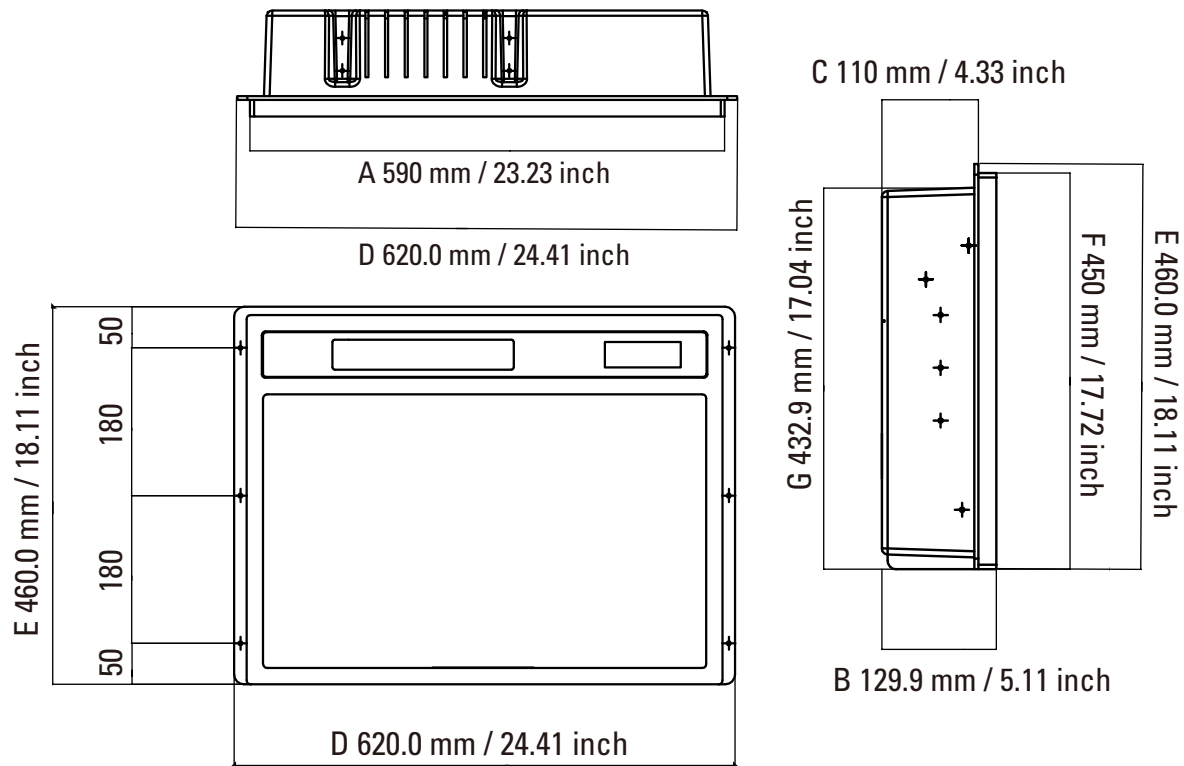

PRODUCT ASSEMBLY

STEP 1

Installing the fireplace insert

Carefully set the fireplace insert into the back of the frame.



NOTE:

DO NOT attempt to install the insert from the front of the mantel - it will not fit.

To enhance the impact resistance of the wooden panel, pre-drilled holes were not provide. Please determine the drilling positions yourself and install the fireplace accordingly. The panel material is easy to drill.

“Wanna show off your hard work? Share a picture of your completed project with other members. Who knows, it might not be as bad as you thought”

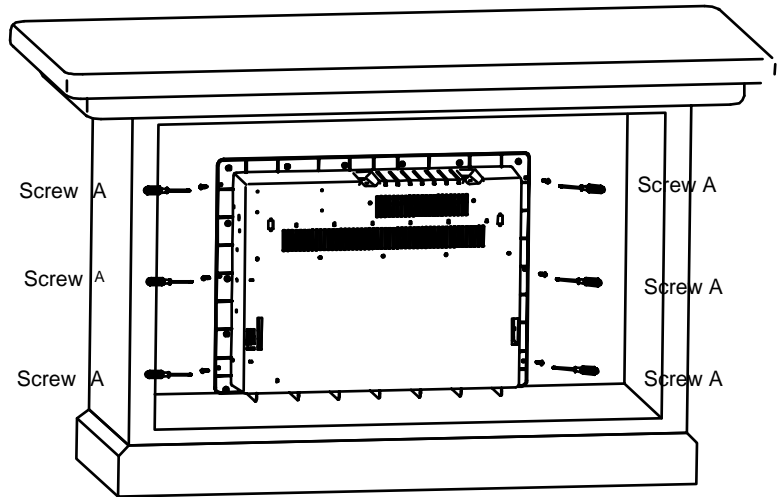

PRODUCT ASSEMBLY

OPERATION

Identifying the control panel

The control panel is located on the top right corner of the fireplace/heater unit.

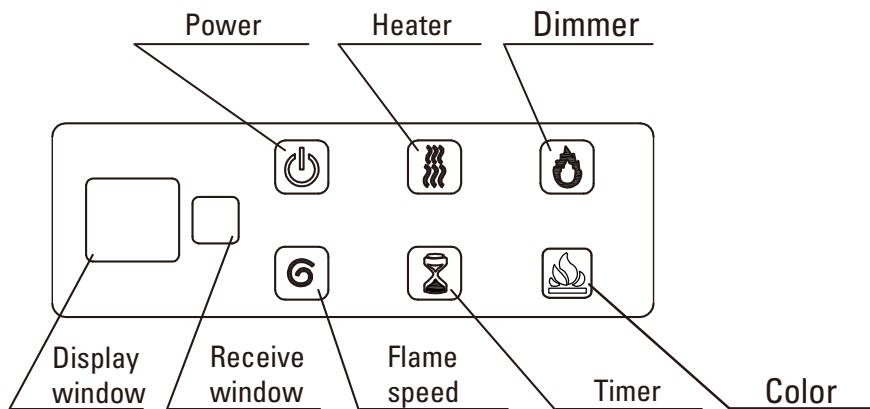





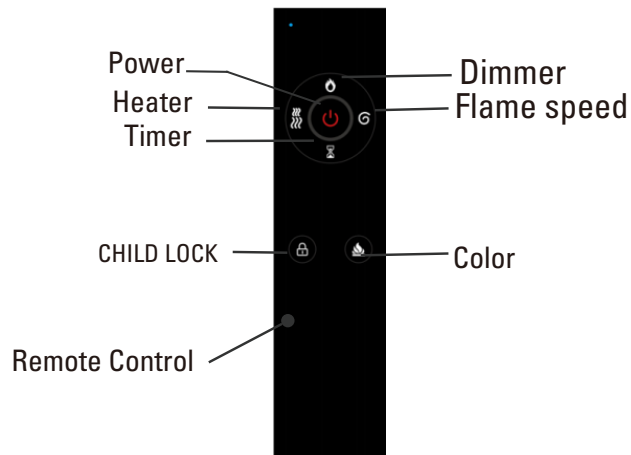

Using the remote control

The operation of the remote control buttons work the same as the buttons on the front panel of the fireplace/heater. Review the Operation section for more information on the functionality of these buttons..



Note: Need to bring AAA batteries, open the remote control back, put the battery, cover the back.

POWER 	Turn the appliance ON/OFF
FLAME SPEED 	Stepper motor speed regulation is divided into five levels, the digital tube shows the lowest u1 file and the highest u5 file.
DIMMER 	Dimming function, Brightness adjustment is divided into 5 levels, the digital tube display L1file is the darkest, L5 file is the brightest, the default L5.
TIMER 	Timing button, maximum timing 8H, 3S no operation after the digital tube out.
HEATER 	Heating button, LL (FAN HEAT1) → HH (FAN HEAT2) → 0F (heating off) cycle.
CHILD LOCK 	Child lock function: Press the child lock button on the remote control in any state, the child lock function takes effect. In this state, pressing any is invalid (Except for the power.press the child lock button on the remote control again to unlock the child lock function.)

COLOR



Electric fireplace flame color change function, electric fireplace flame color change function, flame light board has 3 colors of lamp beads, R= Red, Y= Yellow, B= Blue. The first time when the flame LED light color is on the power on the default color "R-Red", color code for "1", every time you press the keypad or remote control of the flame color change key, the buzzer will be a short sound, the flame color (1-2-3-4-5-6-7) order change once, the digital tube corresponds to display the flame color code. Every time you press the keypad or the remote control's flame color change key the buzzer will sound briefly, and the flame color (1-2-4-5-6-7) will change once in sequence, and the digital tube will display the flame color code correspondingly (1=R, 2=Y, 3=B, 4=R+Y, 5=Y+B, 6=R+B, 7=R+Y+B.).

* When pressing the current key for the first time during intermittent operation, the current mode of the key function is confirmed without enabling the current key function, and the current key function is enabled only when the key is pressed a second time.

PRODUCT ASSEMBLY

WARNING:

Do not move or remove the mesh trim panel, when the appliance is plugged in and operating. This will cause the remote control and touch panel to no longer function.

NOTICE:

When the heater is first turned on, a slight odor may be present. This is normal and should not occur again unless the heater is not used for a long period of time.

NOTICE:

To improve operation, aim the remote control at the front of the fireplace. **DO NOT** press the buttons too quickly. Give the unit time to respond to each command.

USING THE REMOTE CONTROL

Installing Remote Control Batteries:

The first thing to do with the remote is to remove the battery bracket. when replacing batteries, use AAA batteries
Please replace the batteries in the following order.

1. Remove the battery brackefrom the remote.



2. Insert AAA batteries into the battery bracket, ensuring the button side faces the correct direction and firmly securing them in place.



3. Press the battery bracket into the remote control until it snaps into position.



4. Turn the remote over and aim it towards the fireplace or heater unit. Press the power button on the upper portion and observe the flames. If nothing happens, check to ensure the battery is installed correctly, and try again.

WARNING: DO NOT INGEST BATTERIES

1. Non-rechargeable batteries are not to be recharged.
2. Batteries are to be inserted with the correct polarity.
3. Exhausted batteries are to be removed from the product.
4. Always purchase the correct size and grade of battery most suitable for the intended use.
5. Replace all batteries of a set at the same time..
6. Clean the battery contacts and also those of the device prior to battery installation.
7. Remove batteries from equipment when not used for an extended period of time.



NOTE:

Battery disposal Please always dispose of batteries at a suitable recycling point.



NOTE:

Battery disposal
Please always dispose
of batteries at a
suitable
recycling point.



USING THE REMOTE CONTROL

⚠ WARNING:

Always disconnect from the power supply before cleaning the heater. First turn off the main power. Then remove the electrical plug from the wall outlet.

⚠ WARNING:

Do not use this fireplace insert if any part of it has been under water. Immediately call a qualified service technician to inspect the firebox and replace any part of the electrical system which has been underwater.

The blower motor and flame motor are pre-lubricated for a durable using time and need no further lubrication or maintenance. To remove any accumulation of dust or debris, the soft brush attachment of a vacuum cleaner should occasionally be used to clean the outlet grille of the fan heater.

1. Use a soft, clean cloth that will not scratch the surface when dusting.
2. Use a clean soft cloth dampened with warm water to clean the fireplace surface. Do not use household or abrasive cleaners, as these products may damage the surface.
3. When cleaning the glass viewing screen use a non-abrasive damp cloth with liquid cleaner or soft soap if necessary; Do not use cleaning powders or any other substance with abrasives since these substances will scratch glass.
4. Under no circumstances should this product be operated with a broken or chipped glass panel.
5. Do not strike or slam the glass.
6. In the event that your appliance is stained or otherwise damaged during use, we recommend that you call a professional to it.
7. When not in use please unplug the cord from the outlet to prevent any damage or accidents.

TROUBLESHOOTING

Problem	Solution
The unit does not turn on.	Check that the unit is fully plugged into a standard 120V outlet. Press the power button on the control panel
The unit is on, but there is no flame effect	Open the back panels to check if the flame spindle has fallen off from the spindle motor.
There is a visible flame effect, but the heater does not continue to blow warm air after repeatedly turning on the heater.	Turn on/off the heater button several times to make sure it is in the "ON" position.
The heater does not work, but the power and heater switches are in the "ON" position.	Turn all switches to the "OFF" position and unplug the unit from the wall outlet for 5 minutes. After 5 minutes plug the unit back into the wall outlet. and operate as normal. Make sure that no objects are blocking the air vents on the top and on the front of your fireplace.
Remote control is not working.	Change the remote battery. Operate remote transmitter at a slow measured pace. Press the remote control buttons with an even motion and gentle pressure. Repeatedly pressing buttons in rapid succession may cause the transmitter to malfunction. Stand closer to your fireplace. Remove objects that may block your remote control's ability to communicate with your fireplace.

HELP CENTER

Question about your product? We're here to help. Visit us at:



Chat Support



Product inquiry

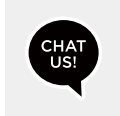

Orders FAQ



Product Assembly



Returns & Refunds

WE STANDS BEHIND THE QUALITY OF THEIR FURNITURE

1. If you have any issues with your item please let us know! We will always do our best to come up with a solution that you will be happy with.
2. Please get in fouch with our cuslomer service feam before returning the product.
- 3.And pls do not throw the original box(es) if you have not finished assembling or confirmed no quality issues.

Length of return period:

Items can be returned within 30 daws ol purchase.

In the meanwhile,everything you purchased from us comes with a one-year warranty.

Who is responsible for the refurn shipping fee:

We will cover the return shipping fees if:

1. Your item has a manufacturing defect in its materials or workmanship. For example, torn wicker or misaligned screw holes. We will send you a prepaid shipping label all photos are sent.
2. Your item has been damaged in transit. For example, glass is broken or wicker is damaged. We will send you a prepaid shipping label after photos are sent.
3. You receive the wrong box(es) due to a warehouse error. We will send you a prepaid shipping label after photos are sent of the wrong SKU numbers on the outer box(es).
4. One or more boxes are lost in transit. We will send you a prepaid shipping label if you no longer want the item.

* However, we still hope to work with you for a better solution instead of a return. Please don't hesitate to contact our customer service team.

Customer will cover the return shipping fees if:

1. You don't like the product(s) after receiving the box(es).
2. You no longer need the product(s) but you have received the box(es)
3. You buy the product(s) by mistake but you have received the box(es).
4. Order/shipment cancellation failed and you have received the box(es)

Return Request

in order to get a full refund as described in this return policy, all items must be: (1) in a brand new/unused condition, please provide photos before and after packaging.(2) When returning, all accessories and parts are firmly packed in all original packaging. If your return does not meet the requirements, you may not get a full refund.

When will I be refunded?

The refund is released once the goods have been returned to our warehouse. What if the product is damaged/defective outside of the valid return period? We want you to be a happy customer. Please reach out to us by email and we will come up with a solution to make sure you are satisfied.

AFTER-SALE SERVICE

Confused? Please contact us in the following ways:

 1. Contact us via our email: patiochicservice@outlook.com

 2. Contact us via our phone: +1 888-572-2312

Working Time: Monday to Friday: EST(Eastern Standard Time) 9am-12am,
1pm-6pm

 3. Go to Your Orders Click "Contact Seller" to describe the issue.

Please feel free to send us the text or email.

We will reply to you within 24 hours. Also please feel free to contact us if you have received the defective items.

Due to time zone differences, please use email as your first choice to communicate with us.

SAVE THESE INSTRUCTIONS

