

Large dog bed

Instruction Manual

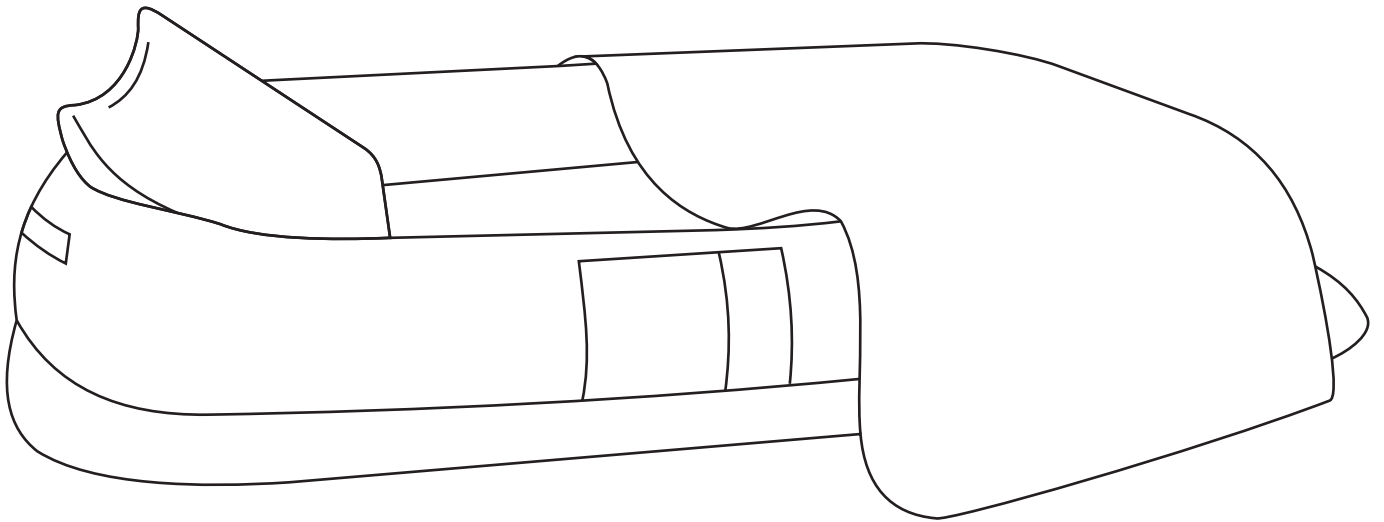

How to open the packaging

1

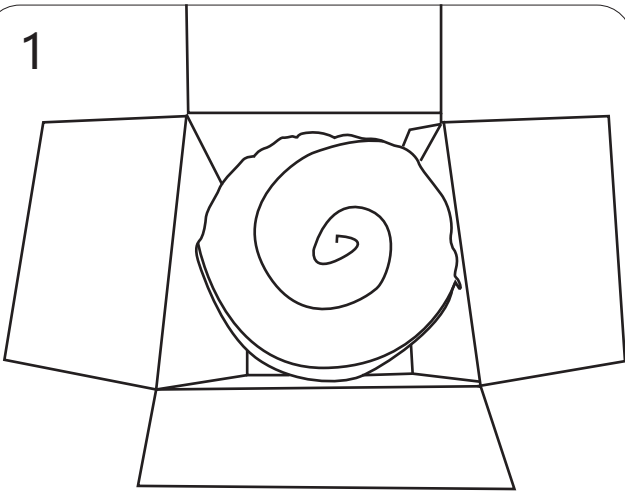

Take the dog bed out of the box

2

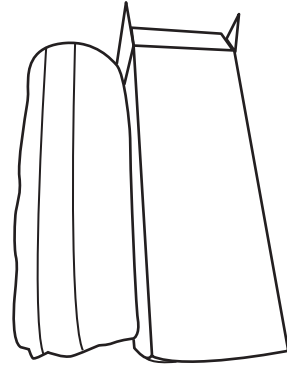

Take out the dog bed from the plastic bag

3

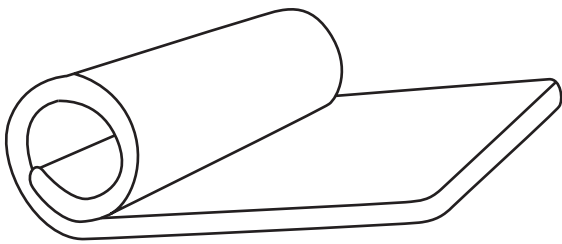

Put the compressed dog bed on a clean and flat surface

4

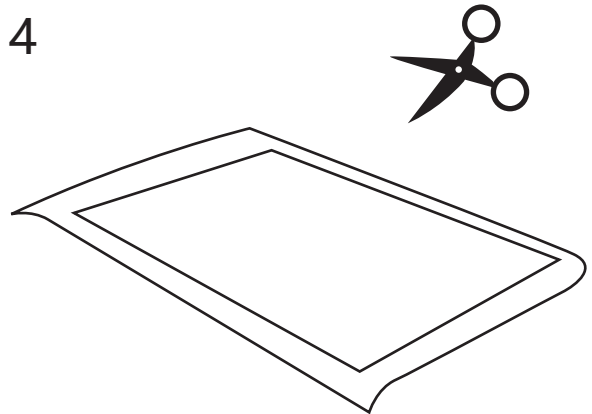

Carefully open the plastic bag along the edge and remove the dog bed, then take out the bag

5

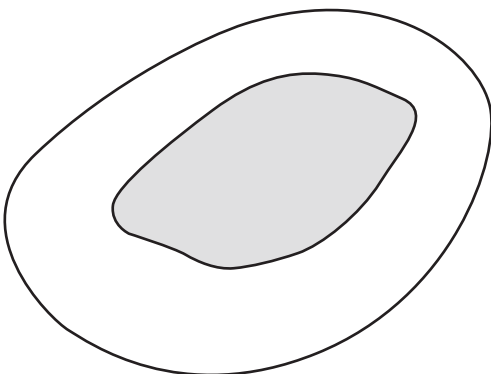



1. Assemble on a flat, clean, and soft surface.
2. Confirm all parts are present prior to assembly.

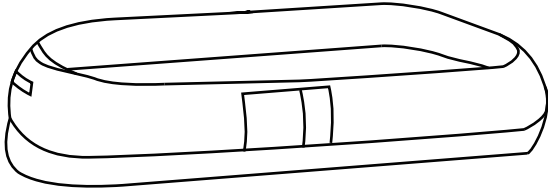

Dog Bed

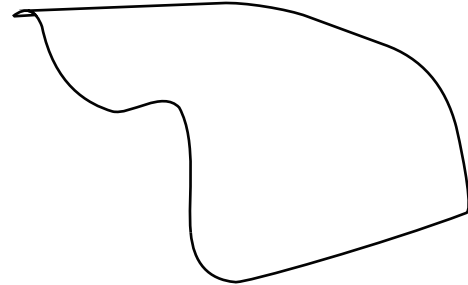

Blanket

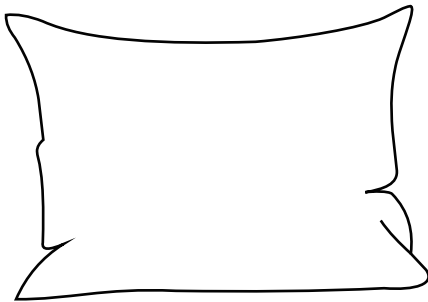

Pillow

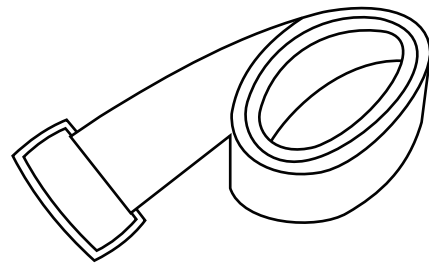

Strap

Instruction Manual

STEP 1

Place it on a flat, soft surface and gently shake the bed frame.

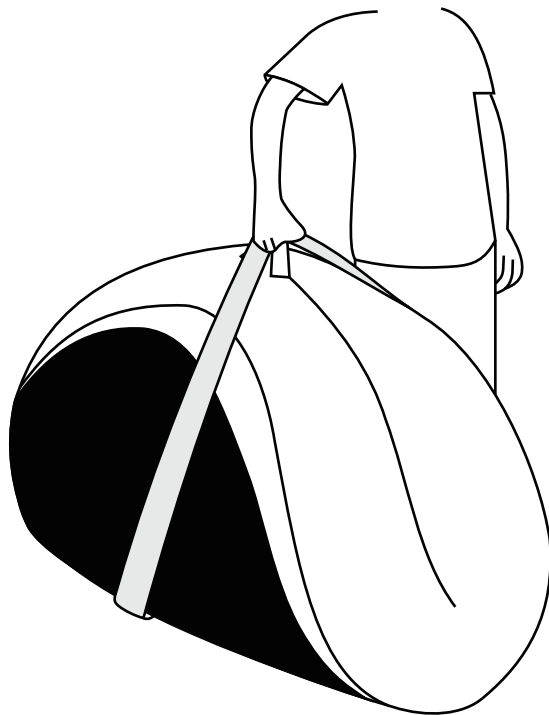

STEP 2

After 24-48 hours, the dog bed will fully expand and you can enjoy it.

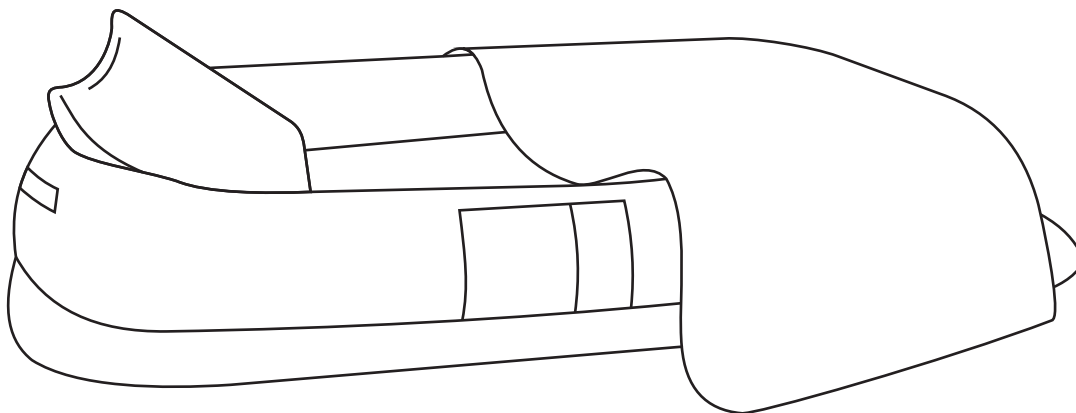

Cleaning Instruction

STEP 1

Pull open the bottom zipper and remove the entire foam.

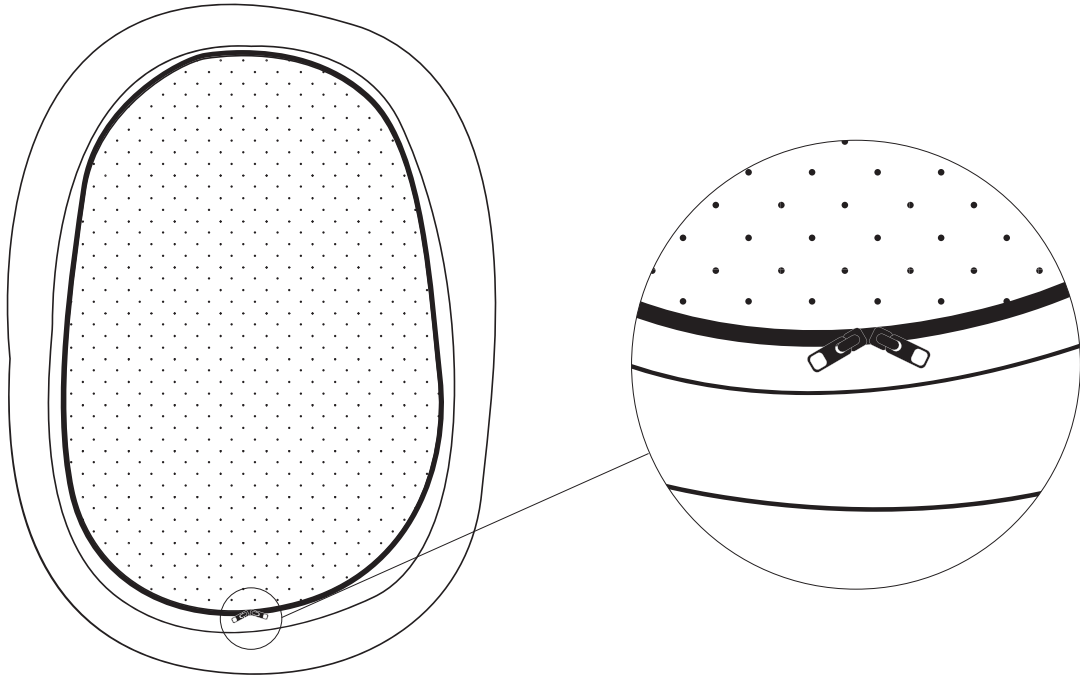

STEP 2

Pull open the inner zipper and remove the inner fiber out of the bolster.

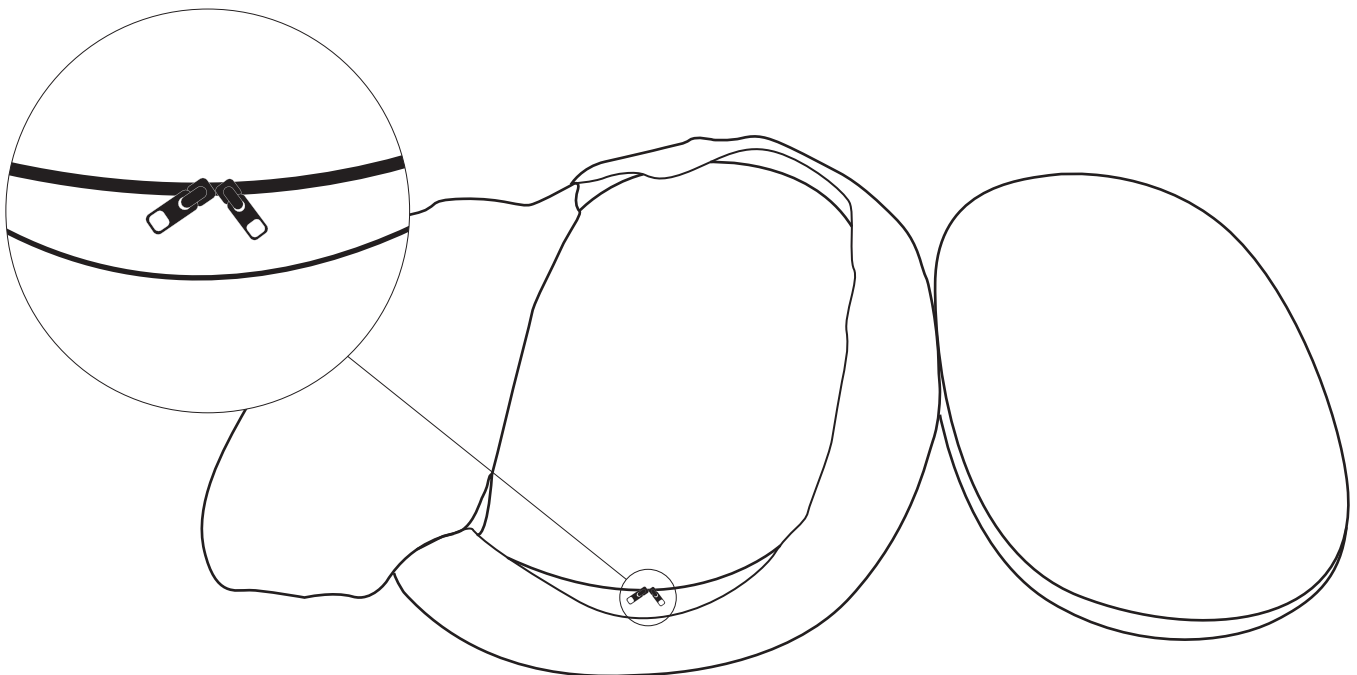

Cleaning Instruction

STEP 3

Place the removable plush cover into the machine for cleaning.



Machine Washable



Water Under 30



Hand Wash



Tumble Dry Low Heat

AFTER-SALES SERVICE CARD

We sincerely thank you for trusting our service and our products, and may this product add enrichment to your home. We guarantee that the product has undergone strict quality inspection and meticulous packaging. If you encounter any issue regarding either shipping or the product, please feel free to contact us at any time. We'd be more than happy to serve you wholeheartedly.

Yours Sincerely

- Please avoid harsh, corrosive and abrasive cleaners.

If you have any questions or concerns please feel free to contact us. We're committed to providing our customers with the quality service.