

# ESSENTIA SURFACES LAMINATE FLOORING INSTALLATION INSTRUCTIONS

---

**PLEASE READ AND UNDERSTAND ALL SECTIONS IN THIS MANUAL BEFORE YOU BEGIN YOUR INSTALLATION.**

For additional information please call 1.888.255.3412.



**WARNING! DO NOT SAND, DRY SWEEP, DRY SCRAPE, DRILL, SAW, BEADBLAST OR MECHANICALLY CHIP OR PULVERIZE EXISTING RESILIENT FLOORING, BACKING, LINING FELT, ASPHALTIC "CUTBACK" ADHESIVES OR OTHER ADHESIVES.**

These products may contain asbestos fibers and/or crystalline silica. Avoid creating dust. Inhalation of such dust is a cancer and respiratory tract hazard. Smoking by individuals exposed to asbestos fibers greatly increases the risk of serious bodily harm. Unless positively certain that the product to be removed is a non-asbestos containing material, you must presume it contains asbestos. Regulations may require that the material be tested to determine asbestos content. See current edition of the Resilient Floor Covering Institute (RFCI) publication, "Recommended Work Practices for Removal of Resilient Floor Coverings" for detailed information and instructions on removing all resilient covering structures. For current information, go to [www.rfci.com](http://www.rfci.com).

**WARNING:**

Drilling, sawing, sanding or machining wood products can expose you to wood dust, a substance known to the State of California to cause cancer. Avoid inhaling wood dust or use a dust mask or other safeguards for personal protection. For more information go to [www.P65Warnings.ca.gov/wood](http://www.P65Warnings.ca.gov/wood).

**CAUTION:**

- Use a dust mask, safety glasses and gloves when cutting Essentia Surfaces flooring.
- If using power tools to cut planks, always cut in a well-ventilated area.
- Never use tools designed for other flooring installation systems (eg. seam rollers, tap blocks, etc.).
- Never wax, polish or use abrasive cleaners on Essentia Surfaces floors as they may damage the floor's finish beyond repair.
- This product is a floating floor. It should not be nailed/screwed to subfloor or in anyway pinned to the subfloor by the installation of furniture or cabinets.

**NOTE:** If excessive moisture accumulates in buildings or on building materials, mold and/or mildew growth can occur. Care should be taken to address any moisture related issues prior to installing Essentia Surfaces.

## INTENDED USE

Essentia Surfaces floors are intended for indoor use only and can be installed in any room as long as it does not have in-floor drainage. All Essentia Surfaces floors have been designed to withstand the requirements of the busiest households as well as limited commercial applications. Prior to installing Essentia Surfaces floors, please refer to the Essentia Surfaces Approved Placement document and read the warranty documentation specific to your application to determine its suitability.

## HANDLING

- Handle Essentia Surfaces with care prior to installation; protect carton edges, do not drop cartons, etc.
- Always store Essentia Surfaces cartons flat and properly supported on a level surface.
- Never lean cartons against walls and do not store them on saw-horses or similar equipment that does not fully support the full length of the cartons.

# ESSENTIA SURFACES LAMINATE FLOORING INSTALLATION INSTRUCTIONS

## TOOLS & MATERIALS

- Measuring tape
- Pencil or marker
- Utility knife
- Pull bar
- 2" (51 mm) wide moisture resistant adhesive tape
- Handsaw or door jamb saw
- 3/8" (10 mm) spacers
- Saw (any of the following):
  - Guillotine-type cutter
  - Table saw
  - Miter saw
  - Circular saw
  - Jigsaw
- Safety glasses & dust mask (NIOSH designated)
- Appropriate glue if installing in areas where planks cannot be angled (e.g. under door jambs)
- 100% flexible neutral curing silicone caulking if installing in moisture prone areas
- PE backer rod if installing in moisture prone areas

## PRE-INSTALLATION

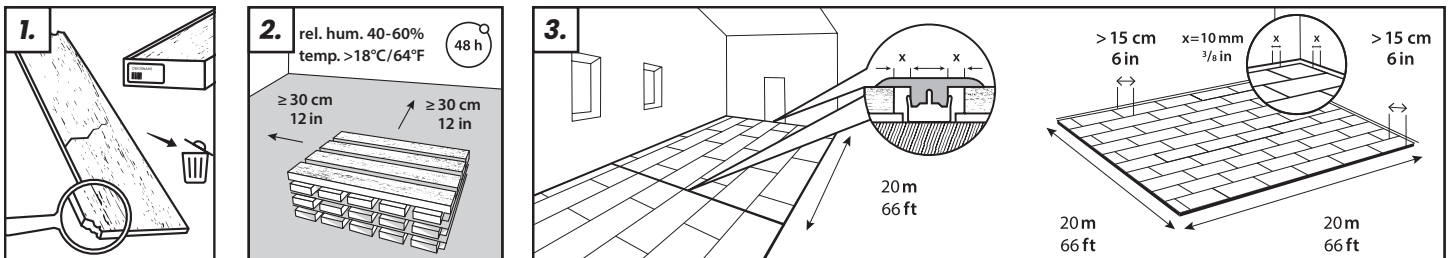

### 1. EXAMINE PLANKS

Check all planks for color against samples used in selection to ensure correct product. Further, inspect for defects and transportation damage. Any planks that show damage or defects should not be used.

### 2. ACCLIMATION

Best practices require 48 hours to acclimate Essentia Surfaces to the conditions of the installation area. To acclimate: cross-stack unopened cartons in the installation area and at room temperature approx. 64°F-73°F (18°C-23°C).

### 3. TRANSITIONS

It is recommended that transitions (T-Moldings) be used to separate rooms. If using transitions, ensure the necessary expansion space is left between Essentia Surfaces planks and the vertical section of the T-Molding.

#### EXPANSION SPACE

For installations up to 40' in length or width, it is necessary to leave a 3/8" (10mm) expansion space around the perimeter of the room and all other objects (e.g. toe kicks, plumbing, etc.). For longer installations up to 66', a 1/2" (12mm) expansion gap will be required. The expansion space will be covered by the wall base or quarter round once the floor is installed. *If installing in moisture prone areas, please refer to the Recommendations for Wet Area Installation section of this guide.*

#### MAXIMUM SIZE OF AREA

Essentia Surfaces floors can be installed in a single room up to 4,000 ft<sup>2</sup> (372 m<sup>2</sup>) and/or 66 linear feet (20 m) in length or width. Installations in rooms that are over 66 linear feet (20 m) in length and overlaps to adjacent rooms should use expansion joints to divide the floor sections.

## PRE-INSTALLATION CONTINUED

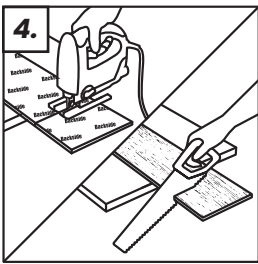

### 4. CUTTING PLANKS

Essentia Surfaces flooring planks are designed to be cut with guillotine-type flooring cutters and power saws (e.g. circular saw, table saw, miter saw, jigsaw) as well as hand saws. It is important to use good quality, sharp blades in order to minimize damage to the planks; however, small chips along the cuts will be hidden by the wall base or trim.

**NOTE:** Essentia Surfaces planks should always be cut away from the installation area in order to minimize debris and dust in the installation site. Always wear protective equipment such as safety glasses, a NIOSH-approved dust mask and gloves.

## SUBFLOOR PREPARATION

Essentia Surfaces floors can be installed over many types of subfloors as long as they are properly prepared and meet the required criteria outlined below.

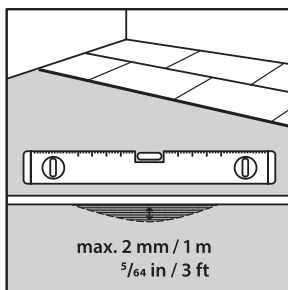
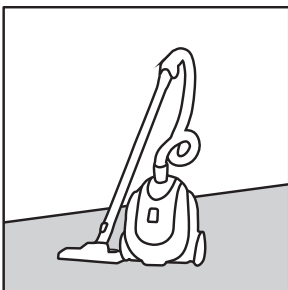

\*equivalent to 1/8" in 6 ft or 3/16" in 10 ft

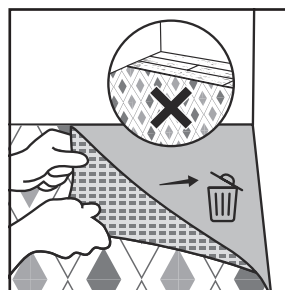

### GENERAL SUBFLOOR PREPARATIONS & PRECAUTIONS

- Subfloors must be clean and free of dirt and debris prior to installation.
- Subfloors must be structurally sound.
- Essentia Surfaces floors can be installed in bathrooms, kitchens, and entryways by following the *Recommendations for Wet Area Installations* section of this guide.
- Variations in the subfloor flatness should not exceed 5/64" per 3 ft (2mm per m) or 3/16" in 10 ft (5 mm in 3 m). Floors must be leveled to meet this specification prior to installation. Level by filling depressed areas with floor leveling compounds and grinding down any raised areas.
- Abrupt height differences of more than 3/64" per 4 in. (1mm per 10cm) must be corrected (for example, nail heads, concrete ridges and other similar small protrusions).
- All carpet, carpet pad and carpet tack must be removed prior to installation.
- Care must be taken to ensure that the subfloor meets all local building codes and regulations. If installation is below grade or on grade, foundation walls must meet all local building codes and regulations.
- Crawl spaces must meet all local building codes and regulations. Any moisture or risk of moisture existing in your crawl space should be mitigated prior to installing Essentia Surfaces.

## SUBFLOOR PREPARATION CONTINUED

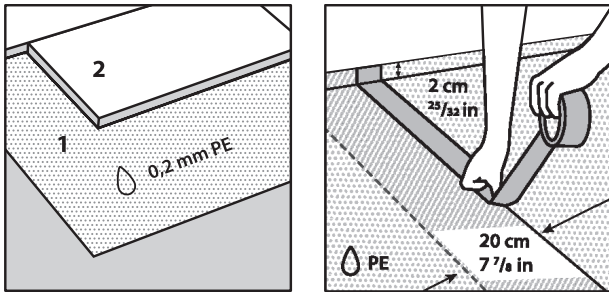

### CONCRETE SUBFLOORS

Concrete subfloors must be properly cured and allowed to dry for at least 60 days prior to installation of Essentia Surfaces. Always test concrete subfloor for moisture prior to installation by following these steps:

- Tape 3' x 3' (91cm x 91cm) pieces of polyethylene vapor barrier to subfloor.
- If condensation appears on the film after 24 hours or concrete appears dark in color, moisture is likely present, and a Calcium Chloride test must be performed.

The maximum allowable moisture emission is 5.0 lbs./1000 ft<sup>2</sup> per 24 hours (2.26 kg/100 m<sup>2</sup> per 24 hours) ASTM F1869. Alternatively, a Tramex test can be performed in accordance with ASTM F2659. However, recorded values higher than 4.5% require a Calcium Chloride test to verify that the subfloor moisture is appropriate. In Situ probe testing can also be used according to ASTM F2170 and the reading should not exceed 75%.

- A vapor barrier must be used when installing over concrete.
- If using a 6mil (0.2mm) polyethylene vapor barrier:
  - Overlap vapor barrier edges by 8" (20cm) and seal with moisture resistant adhesive tape.
  - Run vapor barrier 3/4" (2cm) up the wall and install wall base trim over it.

### WOOD SUBFLOORS

- Wood subfloors must be structurally sound and screwed or nailed to supporting beams.
- Subfloor moisture must be tested prior to installation and should not exceed 12% throughout the installation area.
- Do not install Essentia Surfaces floors over wood subfloors applied directly to concrete.
- Crawl spaces should be dry and vented as per local building code.

### VINYL (SHEET/TILE), LINOLEUM, CERAMIC TILE

- Existing floor covering must be in good condition with no tears, cracks or chips.
- Floor covering should be well bonded to the subfloor and the surface should be flat and smooth.
- Heavily cushioned floor covering (eg. cushion vinyl) and resilient floors that exceed one layer in thickness should be removed. Follow manufacturer's guidelines when uninstalling resilient floor coverings. Wear personal protection equipment (dust mask, gloves, glasses, etc.).
- If installing over ceramic tile, any abrupt unevenness of more than 3/64" per 4 in. (1mm per 10cm) must be corrected.
- If vinyl, linoleum, or ceramic tile is installed over concrete, a vapor barrier must be installed over it.
- If using a 6mil (0.2mm) polyethylene vapor barrier:
  - Overlap vapor barrier edges by 8" (20cm) and seal with moisture resistant adhesive tape.
  - Run vapor barrier 3/4" (2cm) up the wall and install wall base trim over it.

## SUBFLOOR PREPARATION CONTINUED

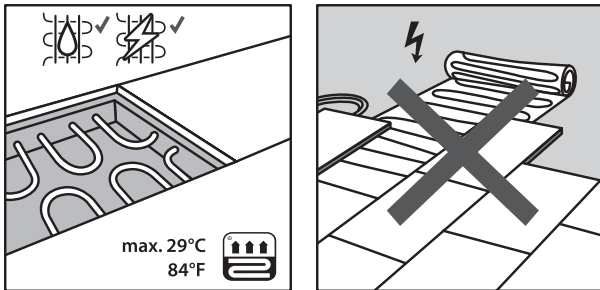

### INSTALLATIONS OVER RADIANT HEATING SYSTEMS

Essentia Surfaces flooring can be installed over embedded in-floor heating systems and must have a minimum of 1/2 in. (12mm) separation from the product. Maximum temperature should never exceed 84° F (29° C).

- In-floor heat systems must be operating for a minimum of 3 weeks prior to installation of Essentia Surfaces floors.
- Floor heating systems should be applied to the entire area of the installation or separated by transitional moldings.

**Refer to radiant heat system manufacturer's recommendations for additional guidance.**

## ROOM PREPARATION

### WALL BASE /TRIM

- Removal of existing wall base/trim is optional. If you decide not to remove your wall base then, you will have to install quarter-round moldings after installation of your Essentia Surfaces floor is complete.
- Wall base or trim will need to be installed once the flooring installation is complete to cover the expansion space around the perimeter of the room.
- Always nail/adhere wall base and trim to the wall. Never nail/adhere it to the flooring.

### CABINETS & ISLANDS

- It is best practice to install cabinets prior to installing Essentia Surfaces floors.
- If cabinets need to be installed after Essentia Surfaces is installed, they should be mounted to the wall and in a manner that does not pin Essentia Surfaces and prevent it from performing as a floating floor.
- Permanent/fixed islands should always be installed prior to installing Essentia Surfaces.
- Free-standing kitchen islands can be placed on top of Essentia Surfaces floors provided:
  - a. They do not exceed 500 lbs (227 kg).
  - b. They are not fastened to or through Essentia Surfaces.
  - c. They do not prevent Essentia Surfaces floors from expanding and contracting.

## ROOM PREPARATION CONTINUED

### DOORS & DOOR JAMBS

Essentia Surfaces floors should be installed under door jambs. As such door jambs will need to be undercut accordingly. To do so:

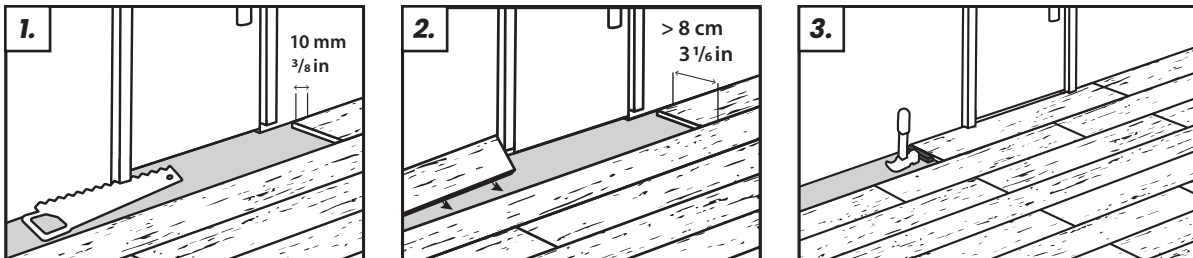

1. Use scrap pieces of Essentia Surfaces flooring and underlayment to support your saw blade at the correct height for undercutting.
2. Measure the size of the door frame and cut a plank to size.
3. Install the planks and use glue to hold the locking system together.
  - Check door clearances and make any necessary height adjustments before installing Essentia Surfaces floors.
  - Make sure to leave the necessary expansion spacing from the wall under the door jamb.

**TIP: If possible, it is often easiest to start the flooring installation the door of the room so that the first plank can be easily slid under the door jamb.**

- In some cases, you may have to modify a plank's locking system as a door jamb may prevent you from angling it into place. To do so, safely remove the vertical section of the groove. This will allow you to slide planks together horizontally. Apply a small amount of adhesive into the plank's groove and slide the plank into place.

### VAPOR BARRIER & UNDERLAYMENT

Install vapor barrier and/or underlayment as per manufacturers' instructions.

#### POLYETHYLENE VAPOUR BARRIER REQUIREMENTS

<b>Thickness</b>	Minimum 6 mil (0.2 mm)
<b>Diffusional resistance (SD-value)</b>	Minimum 75 meter

#### UNDERLAYMENT REQUIREMENTS

<b>Thickness</b>	Maximum 1/8 inch (3 mm)
<b>Compressive strength (CS-value)</b>	Minimum 120 kPa
<b>Compressive creep (CC-value)</b>	Minimum 20 kPa

#### INSTALLING A VAPOR BARRIER - IF APPLICABLE

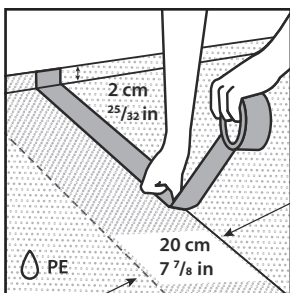

1. Refer to and follow the manufacturer's installation instructions for the correct installation method.
2. If using a 6mil (0.2mm) polyethylene vapor barrier:
  - Overlap vapor barrier edges by 8" (20cm) and seal with moisture resistant adhesive tape.
  - Run vapor barrier 3/4" (2cm) up the wall and install wall base trim over it.
  - Examine the vapor barrier to make sure there are no gaps or wrinkles.

#### INSTALLING AN UNDERLAYMENT

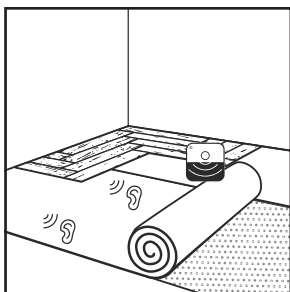

1. Refer to and follow the manufacturer's installation instructions for the correct installation method.
2. Examine the underlayment to make sure there are no gaps or wrinkles.

## INSTALLATION PROCEDURE

- It is recommended that planks be mixed from at least three cartons to achieve the most natural and varied appearance. There are many unique planks in every Essentia Surfaces design. However, during production, the same plank may be inserted into one carton multiple times. It is important to mix planks from multiple cartons and review the installation often to ensure the most random appearance.
- Inspect every plank for damage and visual defects before installing it. DO NOT INSTALL damaged or defective planks.
- Never force planks together using excessive force. If planks are not fitting together easily check joint alignment and inspect for debris in the joints.
- The first and last row of the installation should be wider than 4" (10cm). To ensure this will be the case, prior to installation:
  1. Measure the width of the room and divide it by the width of the planks you are installing.
  2. If the remainder is less than 3.5" (9cm) cut 3.5" (9cm) from the width of the first row. If this is not possible, simply ensure that both edge planks are as even in width as possible.
- The first and last plank in a row should be a minimum of 12" (30cm) long.
- Stagger the planks from row to row by a minimum of 12" (30cm).
- Stand up and walk around the installation every 100 sf to inspect for color and gloss variations, defects, and similar (duplicate) planks adjacent to each other.
- Use spacers to maintain the necessary expansion space between the first row and the wall.
- Select a starting corner of the room and work from left to right.

### INSTALLING THE FIRST ROW

You can connect planks in your first rows in two ways:

#### Method #1:

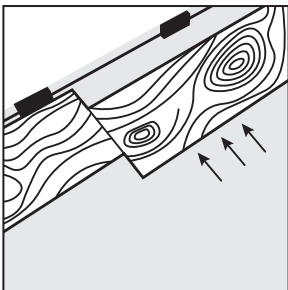

1. Lay the first plank with the long edge tongue facing the wall.
2. Lay the second plank flat on the floor and adjacent to the first plank with the short edge joint aligned with the groove of the first plank.
3. Slide the planks perpendicular to each other engaging the short edge locking system.
4. Continue in this manner until the first row is complete, cutting the last plank to complete the row.
5. Use the remainder of the last plank of the first row to start the second row provided that it is a minimum of 16" (40cm) long.

#### Method #2:

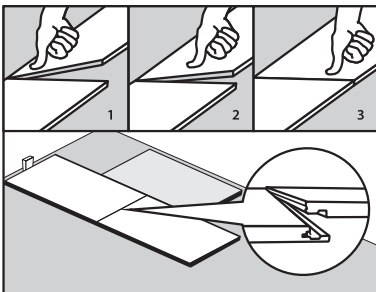

1. Lay the first plank with the long edge tongue facing the wall.
2. Lay the second plank flat on the floor with the short edge joint aligned directly over the groove of the first plank.
3. Apply downward force with thumbs to connect the two planks together.
4. Continue in this manner until the first row is complete. You will have to cut the last plank to complete the row.
5. Use the remainder of the last plank of the first row to start the second row provided that it is a minimum of 16" (40cm) long.

## INSTALLATION PROCEDURE CONTINUED

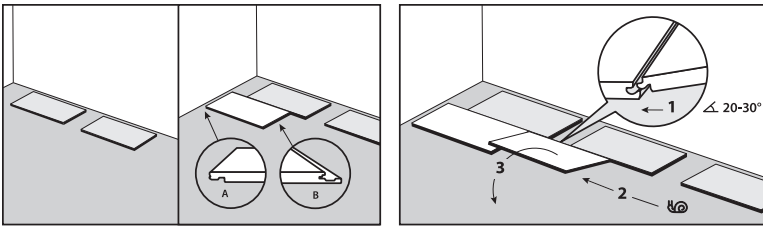

It's important that the long edges of the first row be perfectly straight and aligned in order to facilitate ease of installation of all other rows.

**TIP: You can use an extra plank as an alignment tool. Once you install planks of your first row together, temporarily install an extra plank that spans both first row planks you want to align. This extra plank will automatically align the first row plank's long edges. Do this down the length of your first row. The alignment planks are removed prior to continuing with your installation.**

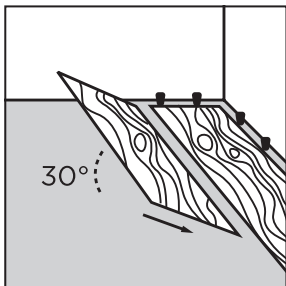
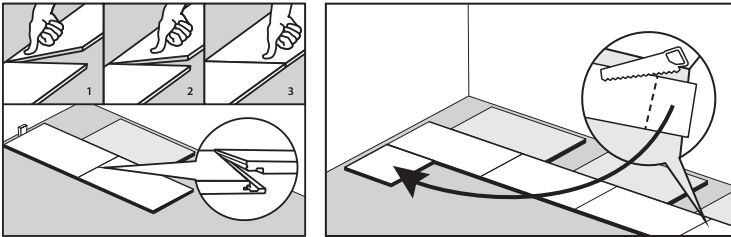

### ALL OTHER ROWS

1. To install the first plank of the second row, place its long edge tongue into the previous row's long edge groove.
2. Lift the long edge groove side only to approximately a 30° angle so the edge you're holding is lifted off the floor, but the opposing long edge is resting in the previous row's groove.
3. Lower the plank to lock it into the previous row (a slight up/down, oscillating movement together with some force in the direction of the previous row may help to lower the plank).

**TIP: Stand up and walk around the installation every 100 sf to inspect for color and gloss variations, defects, and similar (duplicate) planks adjacent to each other.**

4. To install the remaining planks, first install the long edge of the plank you are installing to the previous row
5. Before lowering the plank, make sure its short end tongue overlaps with the previous plank's short end groove.
6. Lower the plank slowly (a short oscillating or up-and-down motion may help to seat the plank into the proper position).
7. Apply pressure to the plank's short edge starting close to the previous row and then engaging towards yourself across the width so as to activate the MegaLoc locking mechanism.
  - i. Thumb pressure should lock the plank in place but if more pressure is required, light tapping with a mallet is acceptable. Do not tap directly onto the installed planks. Place a scrap piece on top of the joint you are working on to tap on.
  - ii. Inspect every joint to ensure it is properly locked. Height differences from plank to plank at the joints is a sign of joints not being properly locked or damaged.

**NOTE: Planks are designed to interlock easily and with a small amount of pressure; if this is not the case, inspect the connection system for damage or debris.**

8. Continue in this manner until your installation is complete.
9. Remove all spacers.
10. Install quarter rounds, base boards and all other moldings.
11. Clean the floor and inspect it to ensure all joints are locked in place.

## INSTALLATION PROCEDURE CONTINUED

### PLANK REMOVAL

- To remove planks, lift the long edge of the last installed row all at once to approximately 30 degrees in order to disconnect the long edge installation mechanism.
- Once this row has been removed, disconnect each individual plank from one another by starting at the right-most plank and sliding it horizontally to disengage it from the previous plank.
- If you plan to re-install them, care should be taken so as not to damage the installation mechanism.

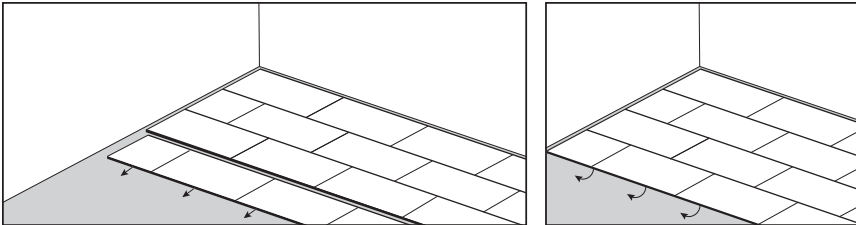

## INSTALLING ON FLOOR IRREGULARITIES

### HOW TO INSTALL AROUND PIPES

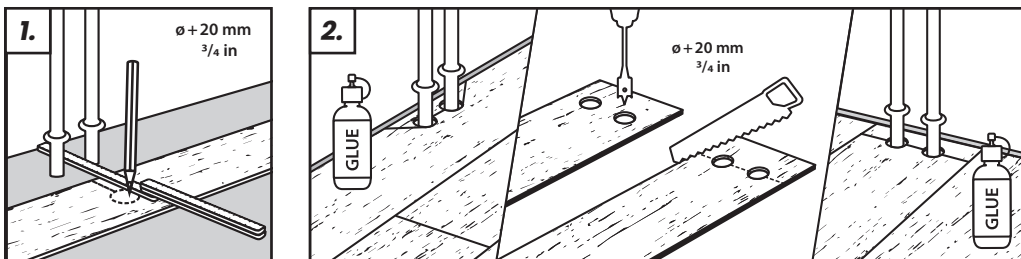

1. Measure and mark the locations on the plank where holes for pipes (or other obstructions) need to be cut out. The diameter of the holes for the pipes should be the pipe diameter plus 3/4 inch (20 mm). This will allow for sufficient clearance.
2. Use a spade bit to drill the holes. Cut away the section of the plank between the edge of the plank and the holes. Install the plank and glue down the section of the plank cut

## INSTALLING AROUND OPEN FLAME FIREPLACES

### ⚠ WARNING

**Do not install flooring under an open flame fireplaces. This will create a fire hazard.**

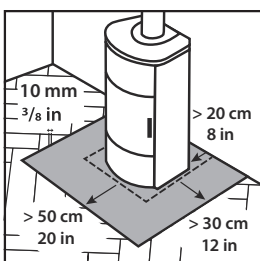

1. Install the flooring at least:
  - 20 inches (50 cm) away from the front of the open flame fireplaces.
  - 12 inches (30 cm) away from the sides of the open flame fireplaces.
  - 8 inches (20 cm) away from the back of the open flame fireplaces.
2. Use appropriate molding to transition from the flooring to the surface beneath the fireplaces for a safe and clean finish.

## RECOMMENDATIONS FOR WET AREA INSTALLATION

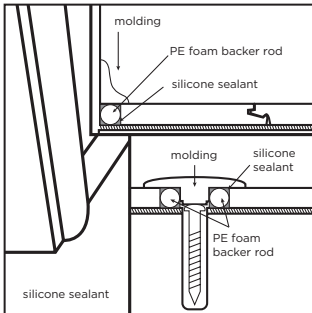

### PROCEDURE:

1. Insert compressible PE foam backer rod into room perimeter expansion space and cover completely with flexible silicone caulk.
2. Insert compressible PE foam backer rod at transitions and cover completely with flexible silicone caulk.
3. Use 100% flexible neutral cure silicone caulking around door frames and other fixed objects (e.g. plumbing).
4. Install baseboards, quarter-rounds or other applicable moldings and immediately wipe up excess caulk.
5. Ensure baseboards or quarter-rounds are attached to walls, not floors.

**Tip:** for ease of installation use PE Foam backer with a diameter closest to the floor's overall thickness.

**NOTE:** PE Foam backers are suggested as a cost-effective option to minimize the excessive use of silicone.

**NOTE:** Do not use acrylic based caulks as they are rigid and will prevent the floor from expanding and contracting. Use only neutral curing 100% flexible silicone caulk.