

TV 1830

ASSEMBLY INSTRUCTIONS

Important note : -
 -Place all wooden part on a clean and smooth surface to avoid the part from being scratch.
 -Keep all hardware part out reach of children.

No	Hardware List	Qty
1	15mm Titus Mini fix 	20
2	Wood dowel 6 x 30mm 	20
3	Hingges 	4
4	M4 x 16mm Screw 	20
5	M4 x 20mm Screw 	16
6	Leg 	4
7	Center leg 	1
8	Power Nail 	24
9	Handle 	2
10	Handle Screw 	2

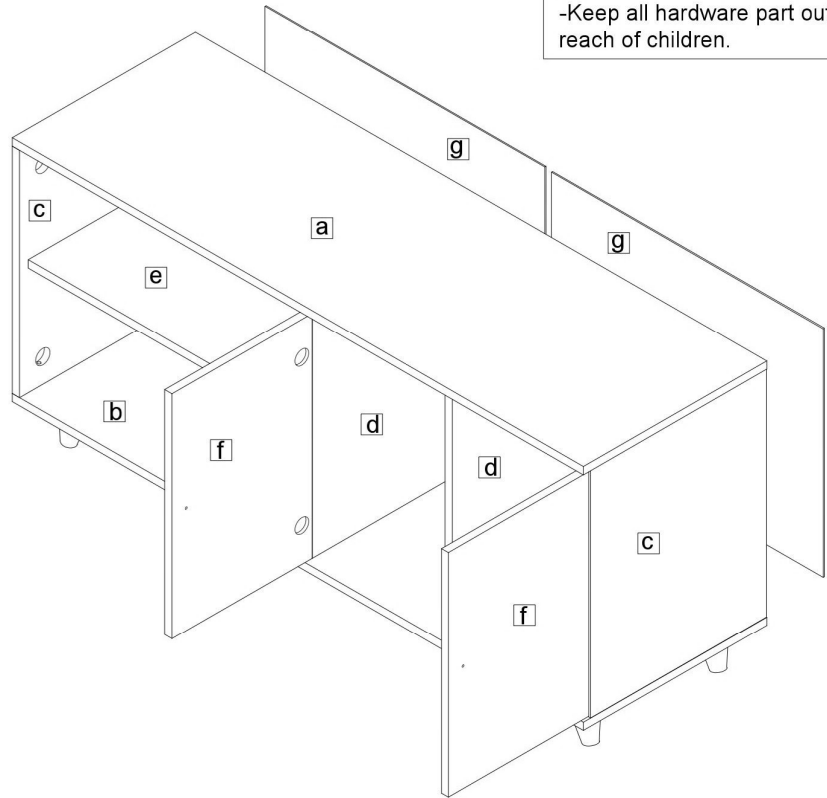

No	Part	Quantity
a	top plank	1
b	bottom plank	1
c	side plank	1L, 1R
d	center plank	2
e	shelf	1
f	door	2
g	back	2

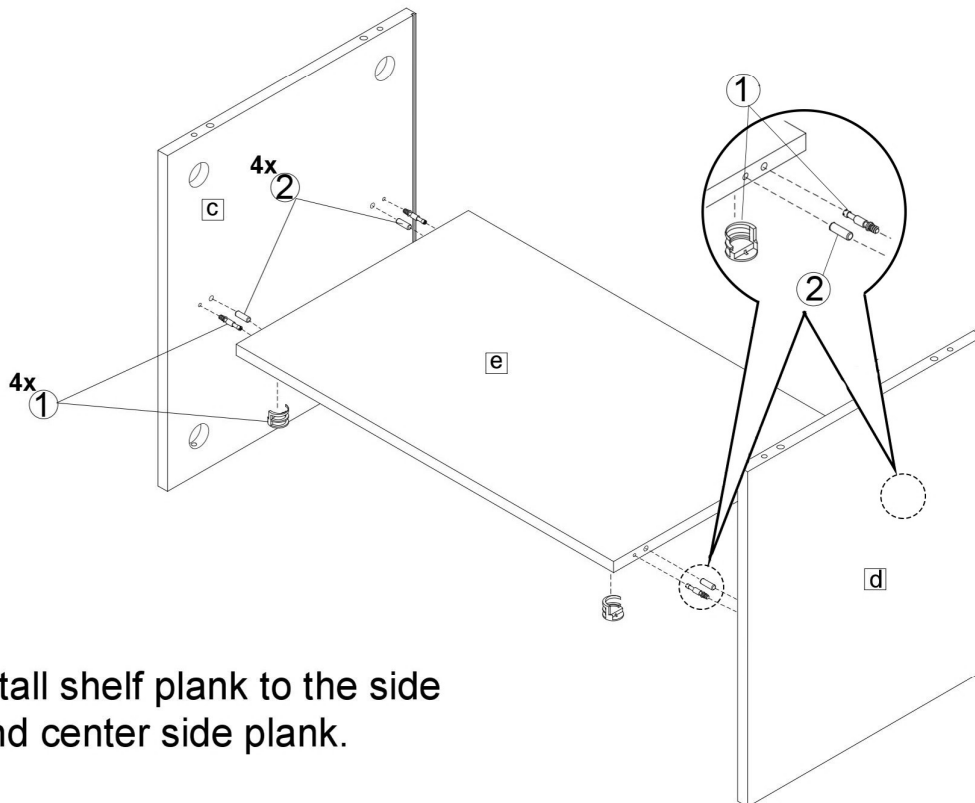

1 . install shelf plank to the side plank and center side plank.

2 . install s/p and center side plank to the bottom.

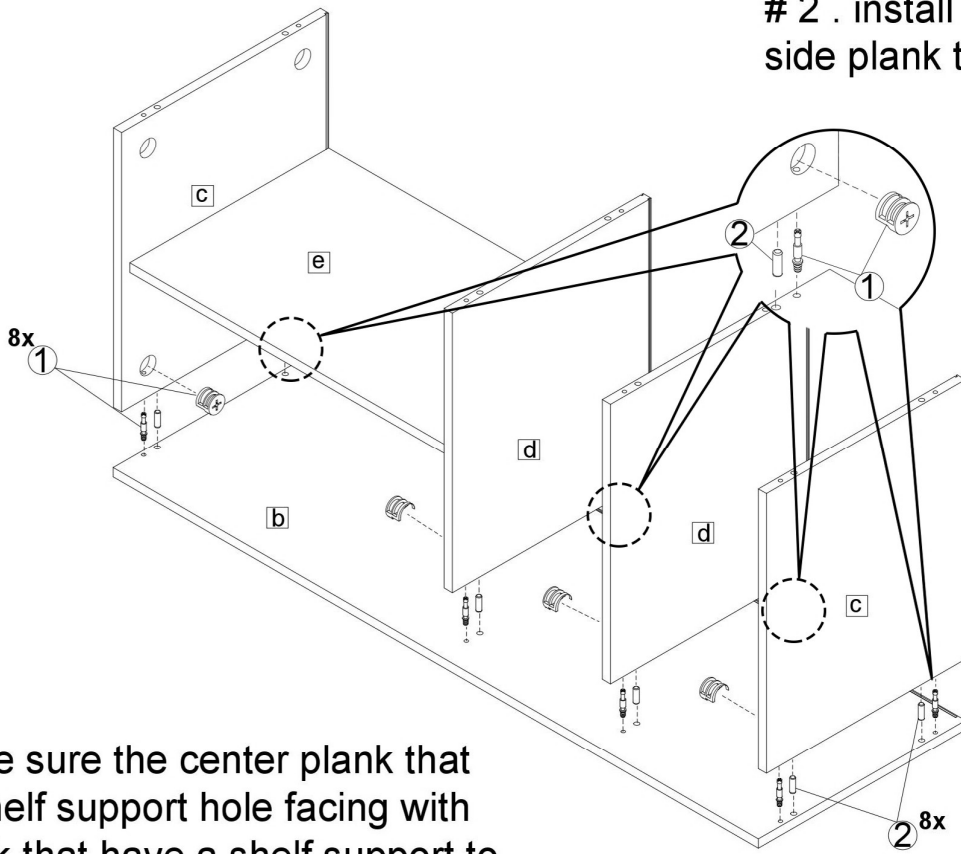

p/s : make sure the center plank that have a shelf support hole facing with side plank that have a shelf support to.

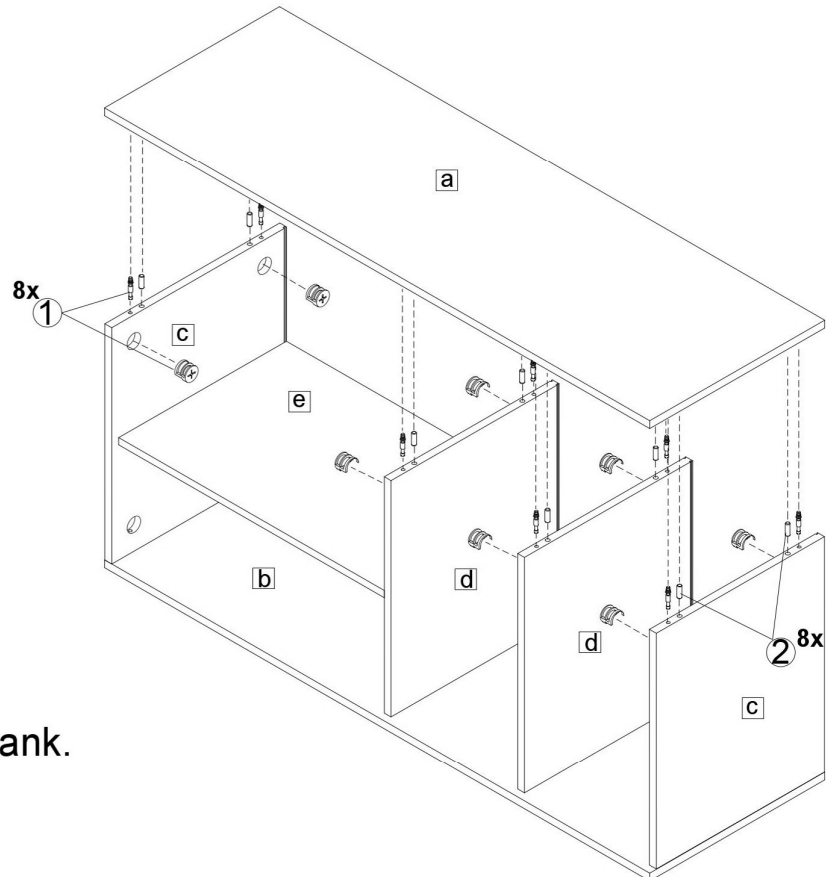

3 . install top plank.

4 . install door plank by using hinges.

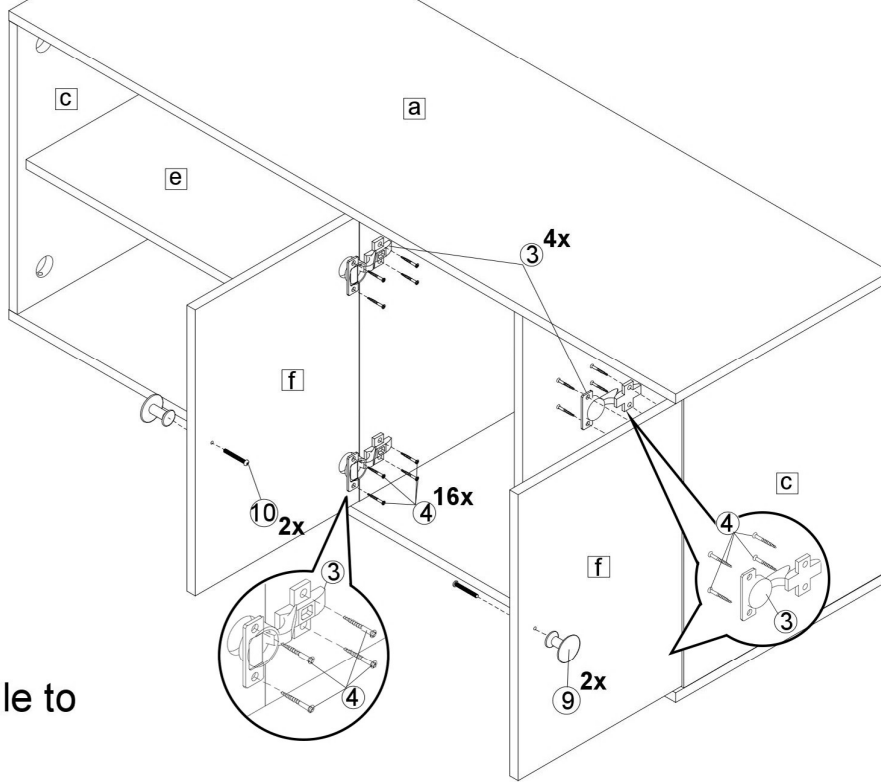

5 . apply handle to the door plank.

6 . install back cover by using the nail. make sure knock slowly until the nail completely inside.

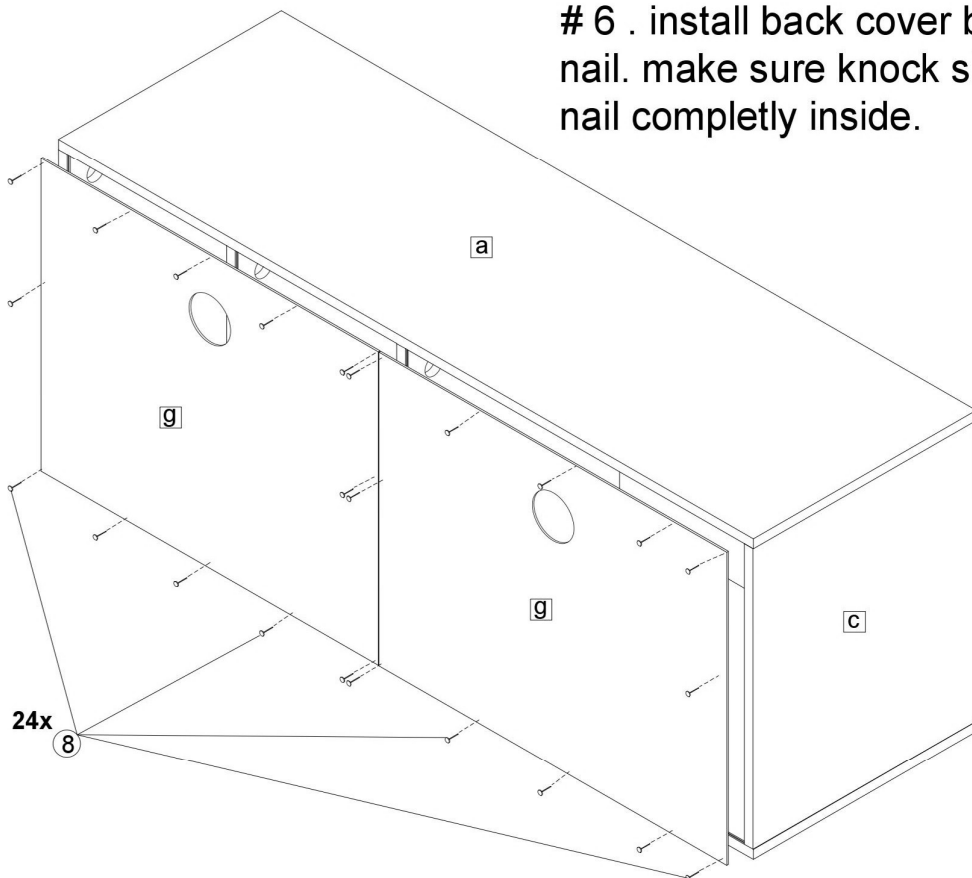

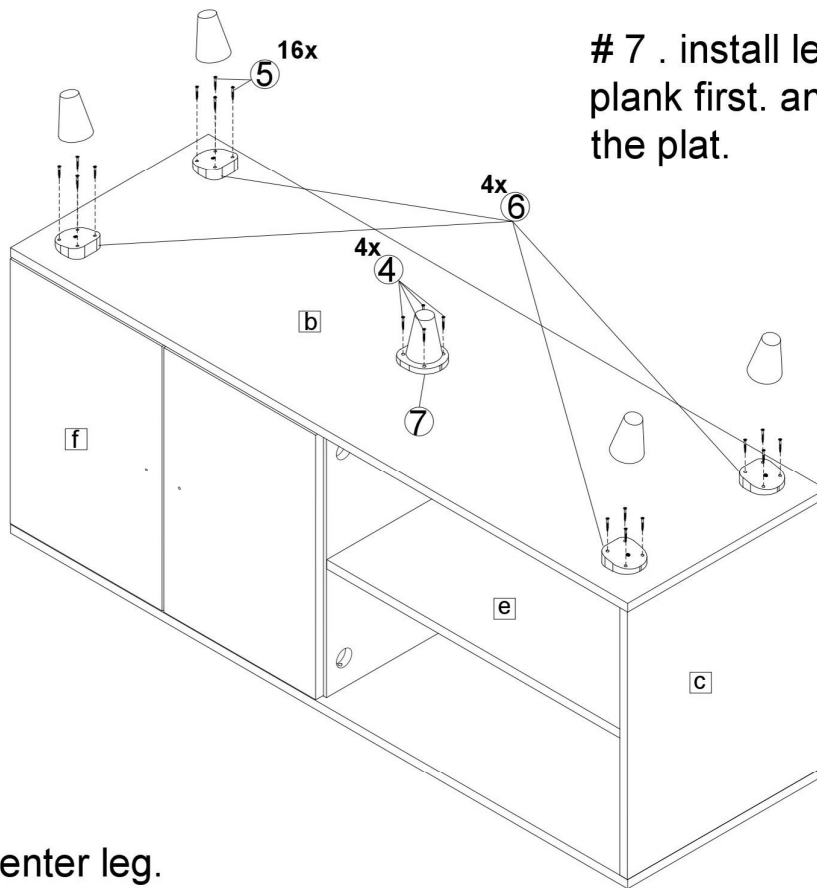

7 . install leg plat to the bottom plank first. and then install leg to the plat.

8 . install center leg.

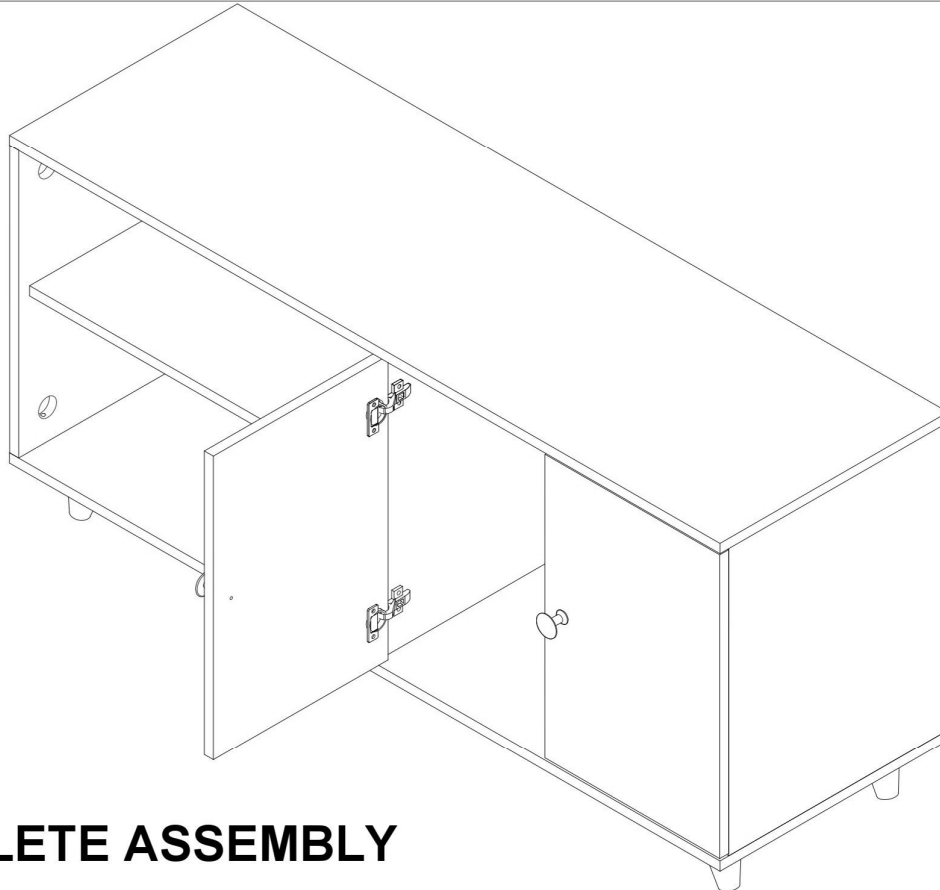

COMPLETE ASSEMBLY