

# Assembly Instructions

**Caution : You must read this before you proceed**

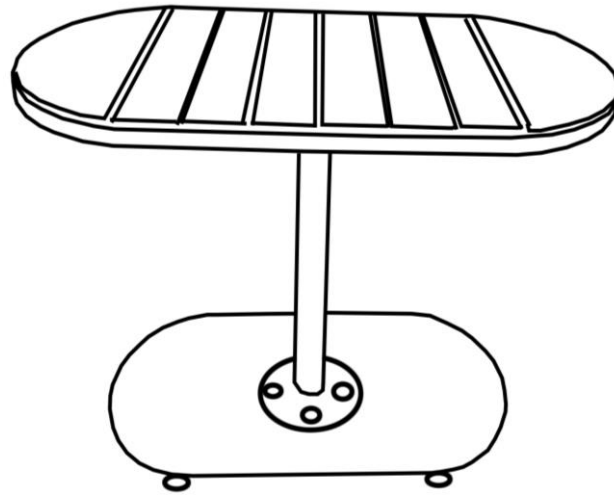

## Table

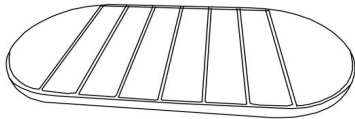
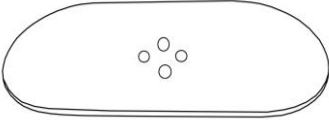
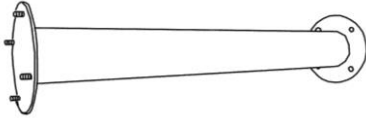

### Parts List

Label	Picture	Description	QTY
A		Table Top	1
B		Table Base	1
C		Support Ring	1

# Hardware

Label	Picture	Description	QTY
①		Nut	9
②		Spanner	1

# Assembly Preparation

Before Beginning Assembly:

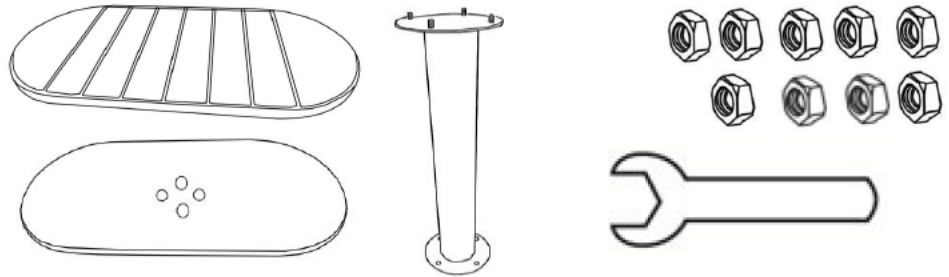

- Read instructions, cover to cover-



- Have 2 adults on hand for assembly-



- Do not assemble on flooring or carpet-



- Assemble on a clean non-marring surface (packing foam)-



- Save all packaging until finished-

# Assembly Steps

## Overview

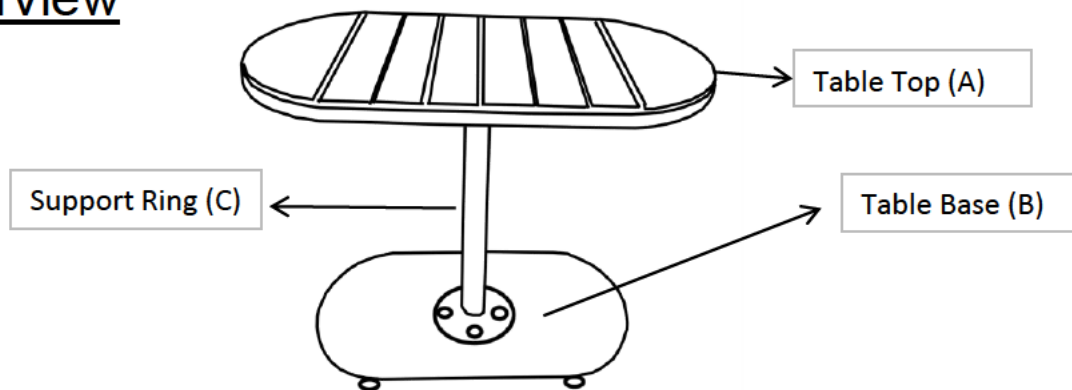

This Table has multiple parts and may require up to 20 minutes to assemble. To give you an overview of the Table parts, the above picture is to help you put the various parts into perspective. Please read through the instructions below to familiarise the parts and steps before assembly.

## Step 1

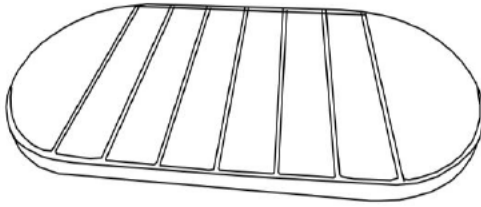

A

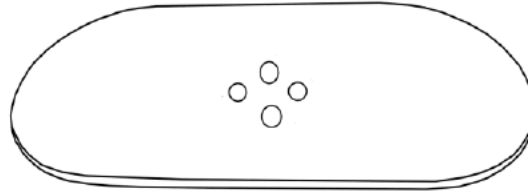

B

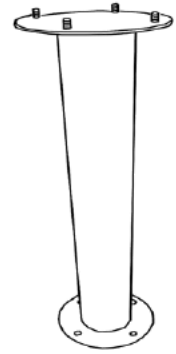

C

Unpack and place all parts on a clean, non-marring surface.

## Step 2

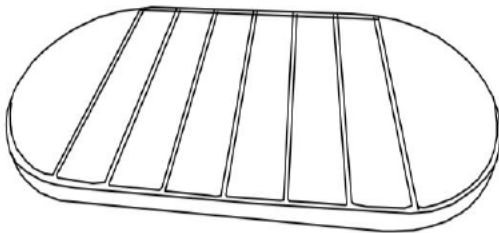

A

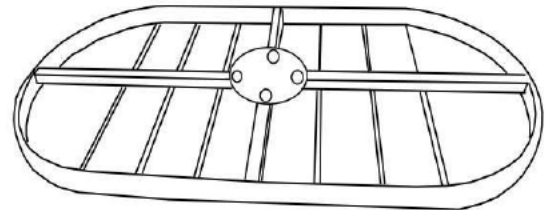

Lay the Table Top(A) facedown onto a clean, non-marring surface.

## Step 3

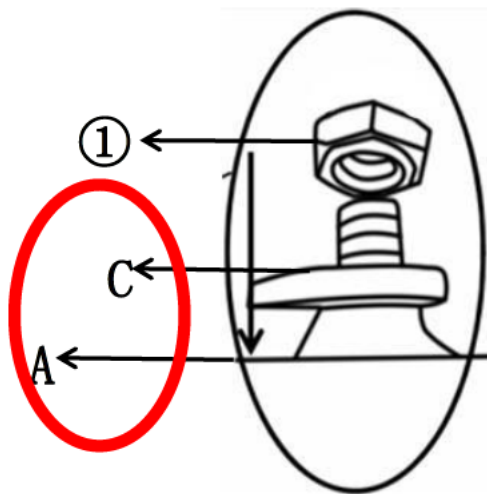

①

C

A

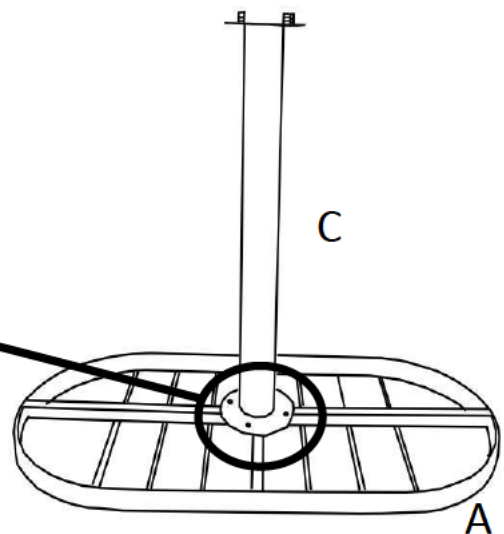

C

A

Attach the Support Ring(C) to Table Top(A) using Nuts(①) with Spanner(②).  
**Do not fully tighten the Bolts.**

## Step 4

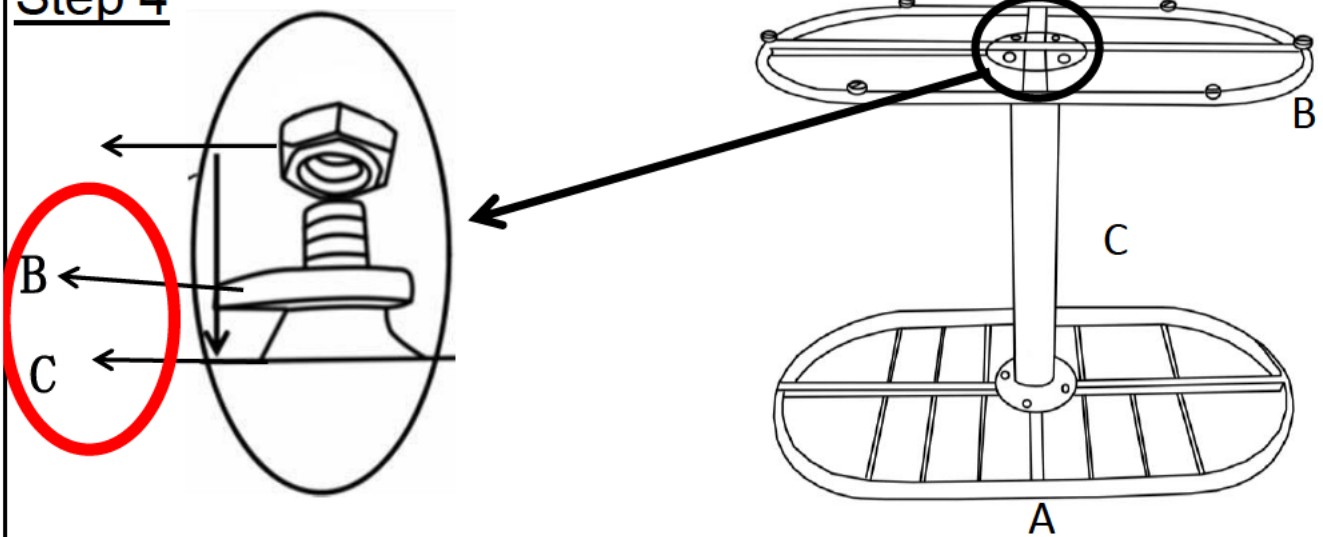

Attach the Support Ring(C) to Table Base(B) using Nuts(①) with Spanner(②).  
**Tighten all Nuts at all joints in a sequential manner.**

## Step 5

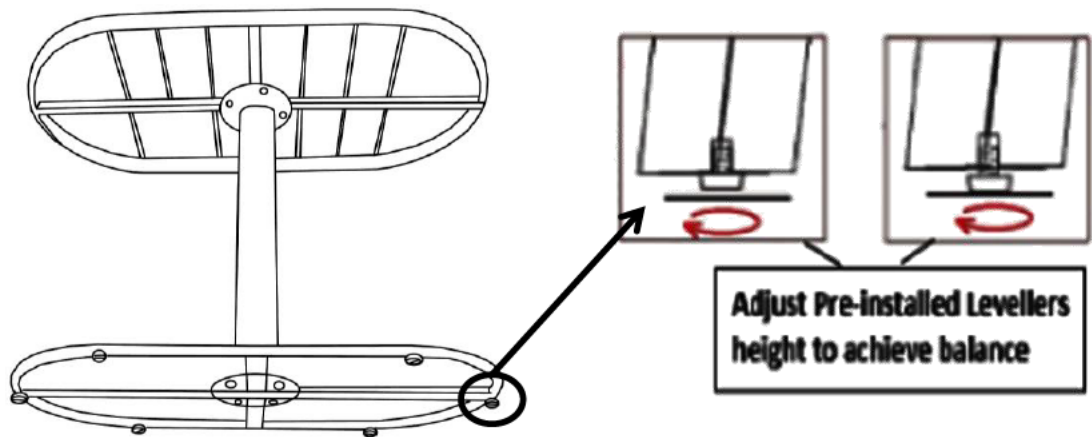





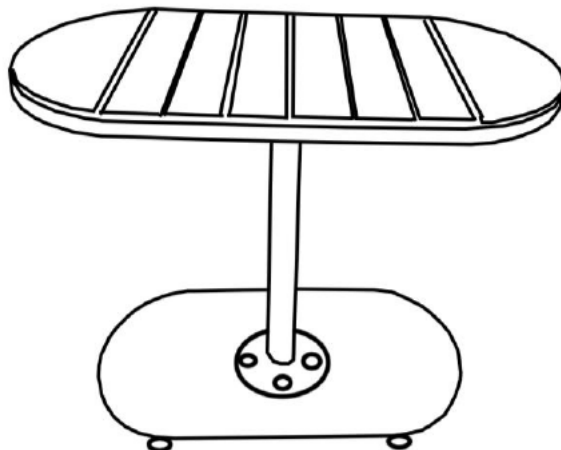













Stand the Table up.  
Adjust the Pre-installed Levellers at the bottom of the Table Base until the Table is level to the ground.

## Step 6



Your Table is ready for use.  
**This Table can only be used on a flat, level surface.**

## Care & Maintenance

-   ● Do not put hot items directly on furniture surface
  -   ● Do not clean furniture with harsh cleansers or polish.
  -   ● To obtain the longest lifespan of your outdoor products, minimizing exposure to direct sunlight is recommended.
  -   ● Children should not climb or jump on the furniture.
  -   ● Do not write on furniture without a padded barrier to protect the surface.
  -   ● To obtain the longest lifespan of your outdoor products, avoid extended and lengthy exposure to rain, snow, and direct sunshine. Whenever possible cover
  -   ● Not for commercial use. For residential use only .
  -   ● Stains may be removed with mild soap solution and damp cloth.
- 
-   ● Dust and pick-up spills using a clean, non-colored, lint-free cloth .

### What is Proposition 65?

Proposition 65 is a California law that requires warning labels on products that may contain one of more than 800-plus chemicals or ingredients that the California Office of Environmental Health Hazard Assessment (OEHHA) has deemed to cause cancer or other reproductive toxicity. Chemicals and elements on this list include wood dust, brass, and other everyday substances, which can be found in very common household items, such as: lamps, tableware, jewelry, crystal glasses, electric cords, beauty products, automobiles, and furniture.

### Why Did I Find a Proposition 65 Warning on My Home Goods Product?

We include Proposition 65 warnings on all of our products because there is always a chance that one of the 800-plus common chemicals and ingredients listed under this law could potentially be on our furniture or packing materials. We risk large fines under this law, if we don't include this warning.

### Should I worry?

We realize you may be worried finding this warning on our products, but we want to reassure you that the hazardous exposure limits for any of these chemicals have never been found on furniture products that we've shipped to our customers. Additionally, this warning label is very common and can be found on almost every piece of furniture sold in the state of California.

### Just How Common Are Proposition 65 Warnings?

Proposition 65 warnings have become so common in California that it is hard to take a trip to a local bank, grocery store, or restaurant without finding at least one warning. In fact, even the Disney Land Resort has a Proposition 65 warning:

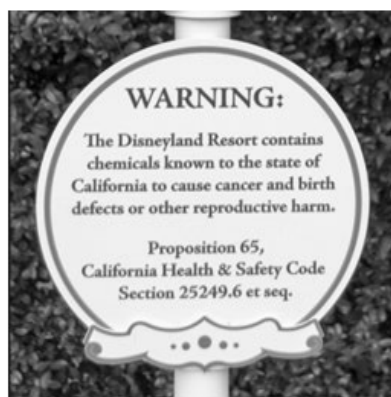

# Assembly Instructions

**Caution : You must read this before you proceed**

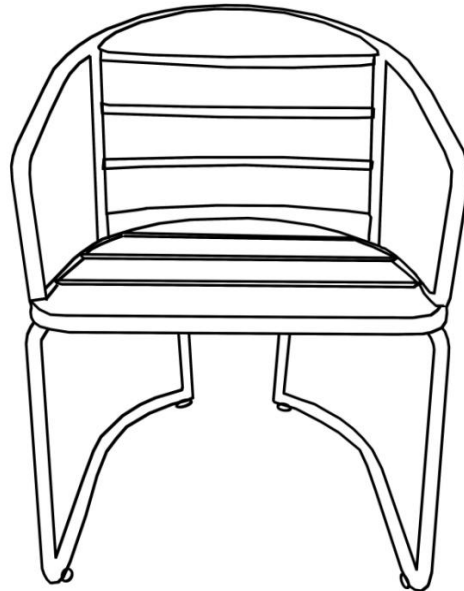

## Chair



### Parts List

Label	Picture	Description	QTY
A	A line drawing of the chair seat, showing the seat and the backrest with three horizontal slats.	Chair Seat	1
B	A line drawing of the left chair leg, showing the leg and the seat attachment point.	Chair Leg (Left)	1
C	A line drawing of the right chair leg, showing the leg and the seat attachment point.	Chair Leg (Right)	1

# Hardware

Label	Picture	Description	QTY
①		Bolt (M8*35MM)	7
②		Washer	7
③		Allen Key	1

# Assembly Preparation

**Before Beginning  
Assembly:**

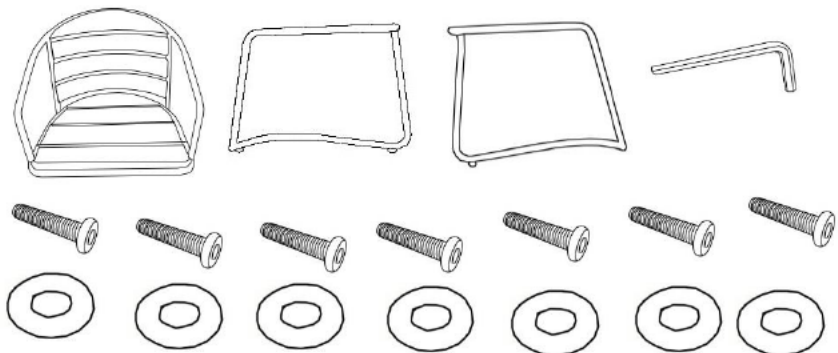

- Read instructions, cover to cover-



- Have 2 adults on hand for assembly-



- Do not assemble on flooring or carpet-



- Assemble on a clean non-marring surface (packing foam)-



- Save all packaging until finished-

# Assembly Steps

## Overview

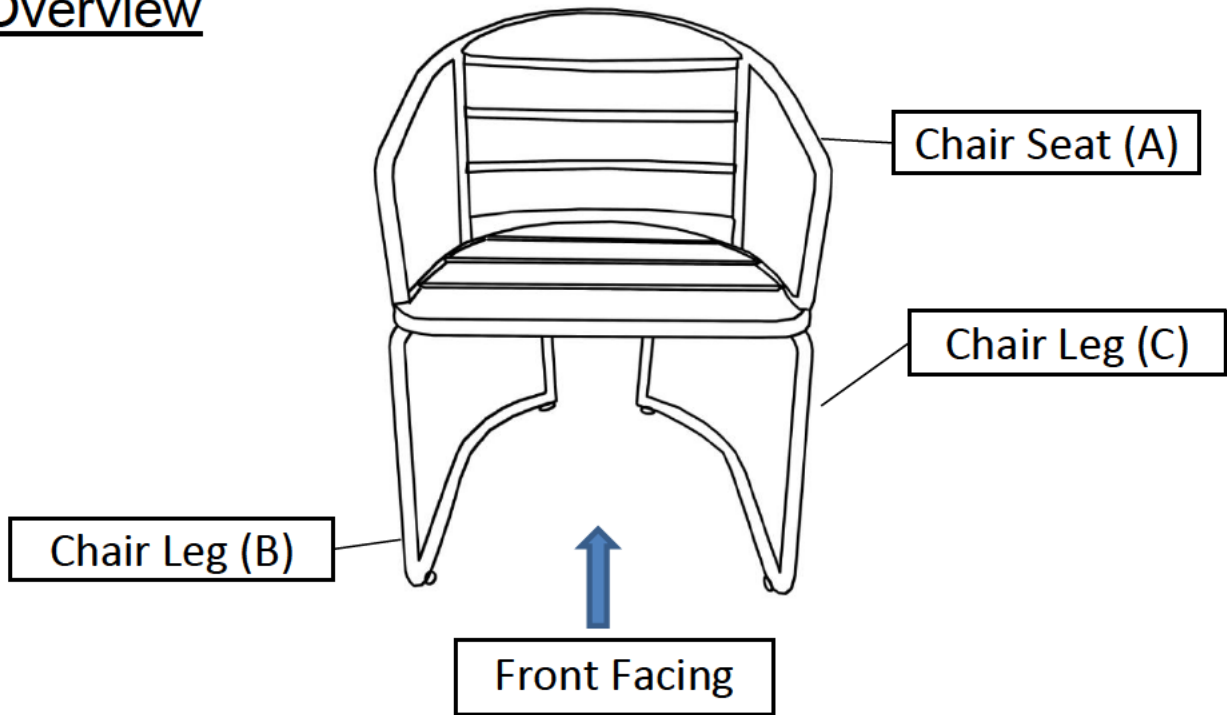

This Chair has multiple parts and may require up to 30 minutes or more to assemble. To give you an overview of the Chair, the above picture is to help you put the various parts into perspective. Please read through the instructions below to familiarise yourself with the parts and steps before assembly.

## Step 1



A

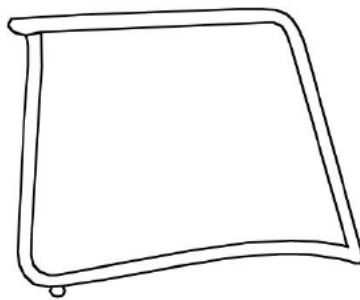

B

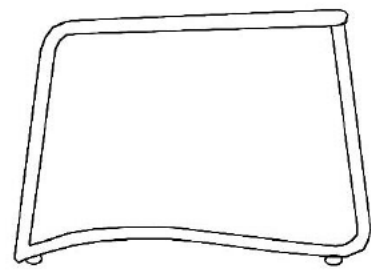

C

Unpack and place all parts on a clean, non-marring surface.

## Step 2

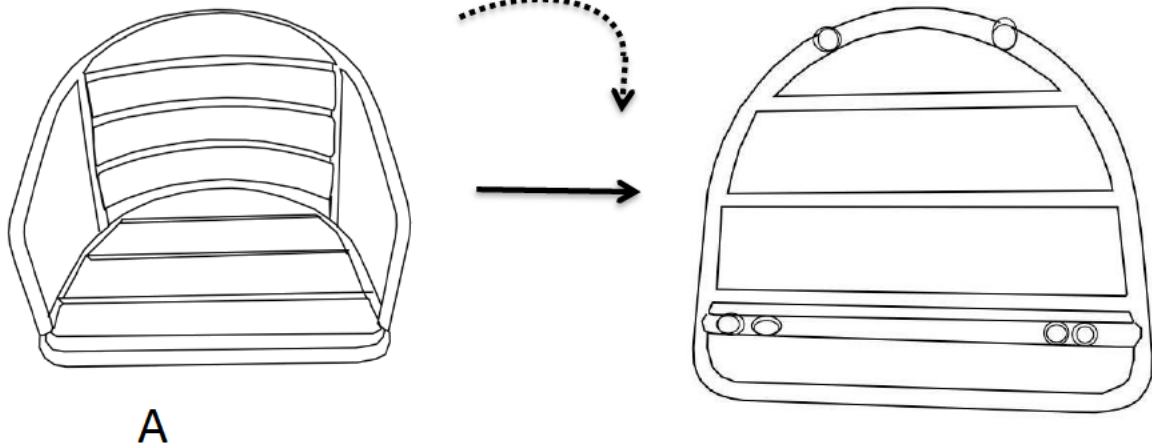

Place the Chair Seat(A) facedown as shown above.

## Step 3

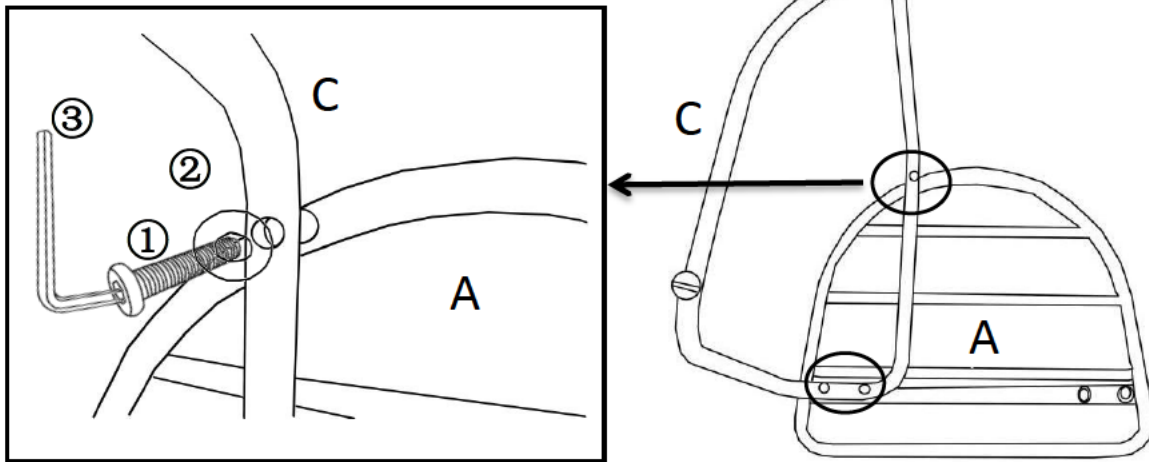

Align the mounting positions on Chair Leg(C) and Chair Seat(A), then attach using Bolts(1) and Washers(2) with Allen Key(3).

**Do not fully tighten the Bolts.**

## Step 4

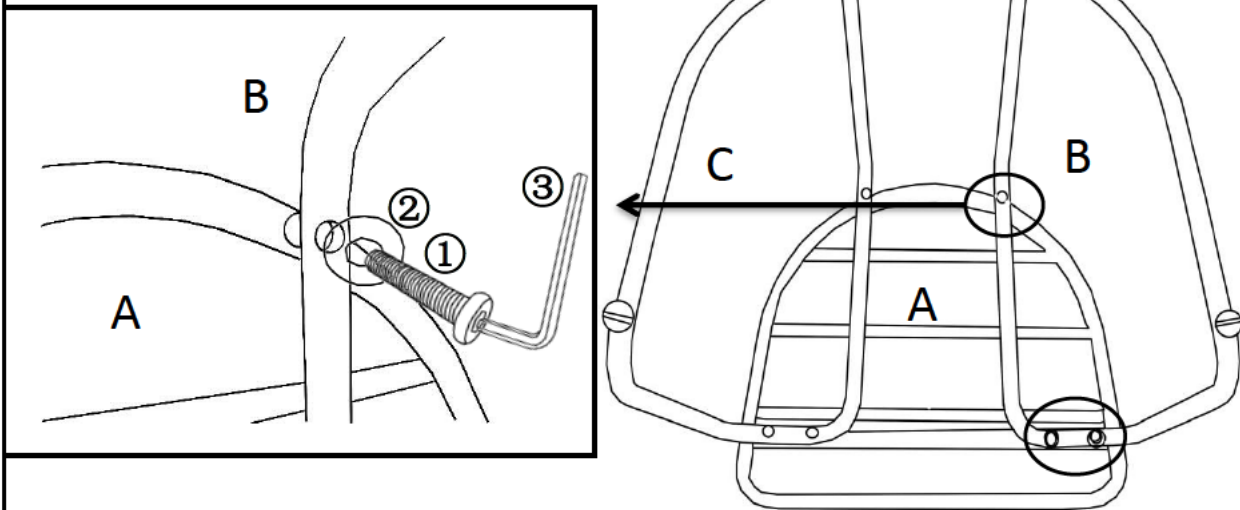

Align the mounting positions on Chair Leg(B) and Chair Seat(A), then attach using Bolts(1) and Washers(2) with Allen Key(3).

**Do not fully tighten the Bolts.**

## Step 5

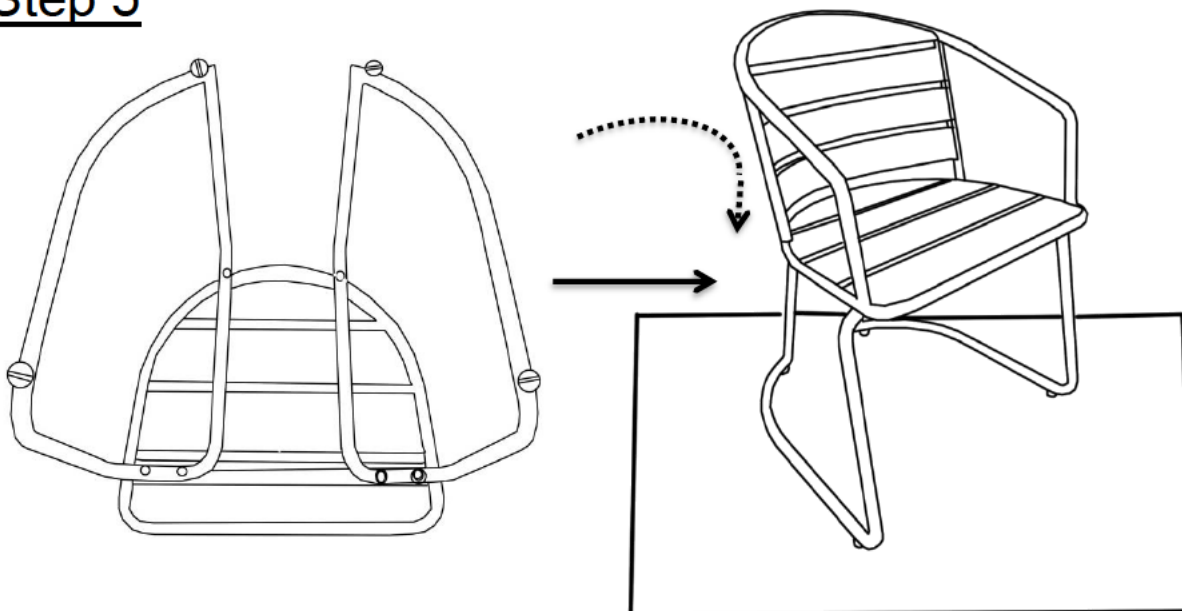

Stand the Chair up.

Carefully and gently sit into the Chair, this action will ensure there are no gaps between the parts.

**Then proceed to tighten all Bolts at all joints in a sequential manner.**

## Step 6

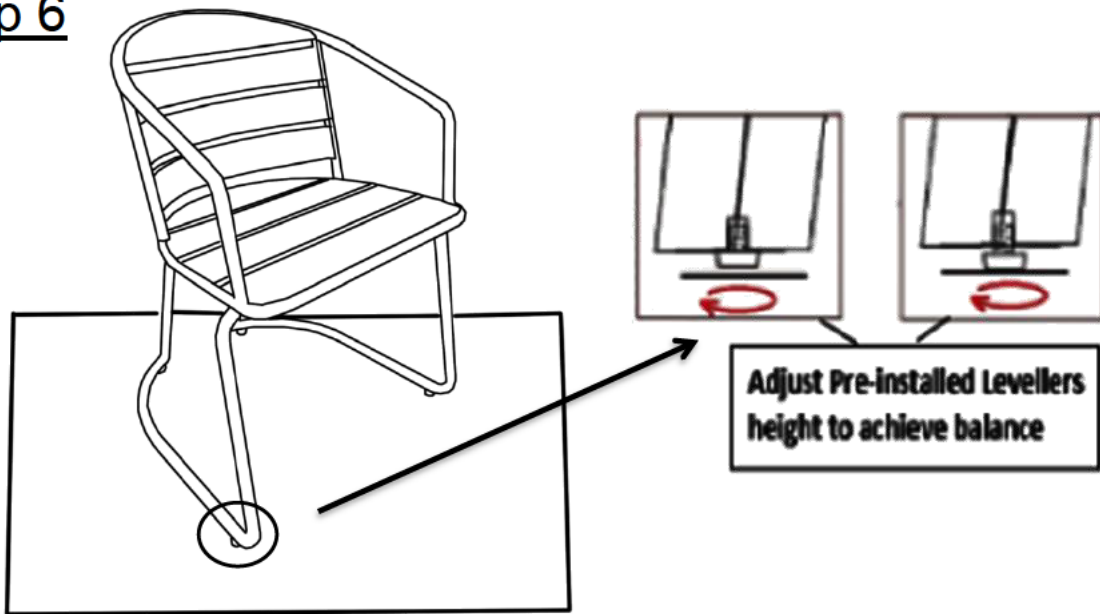





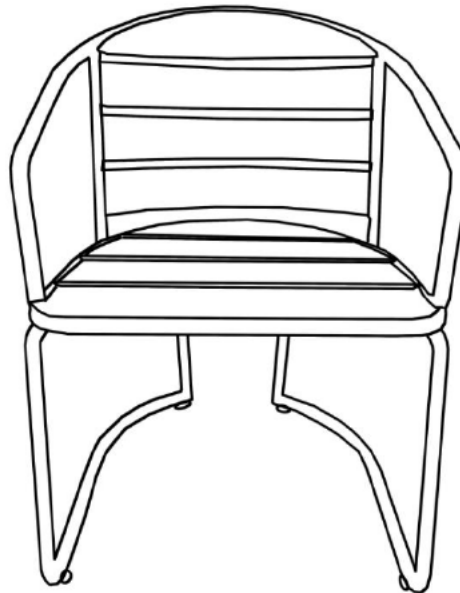













Adjust the Pre-installed Levellers at the base of the Legs until the Chair is level to the ground.

## Step 7



Your Chair is ready for use.  
**This Chair can only be used on a flat, level surface.**

## Care & Maintenance

-   ● Do not put hot items directly on furniture surface
  -   ● Do not clean furniture with harsh cleansers or polish.
  -   ● To obtain the longest lifespan of your outdoor products, minimizing exposure to direct sunlight is recommended.
  -   ● Children should not climb or jump on the furniture.
  -   ● Do not write on furniture without a padded barrier to protect the surface.
  -   ● To obtain the longest lifespan of your outdoor products, avoid extended and lengthy exposure to rain, snow, and direct sunshine. Whenever possible cover
  -   ● Not for commercial use. For residential use only .
  -   ● Stains may be removed with mild soap solution and damp cloth.
- 
-   ● Dust and pick-up spills using a clean, non-colored, lint-free cloth .

### What is Proposition 65?

Proposition 65 is a California law that requires warning labels on products that may contain one of more than 800-plus chemicals or ingredients that the California Office of Environmental Health Hazard Assessment (OEHHA) has deemed to cause cancer or other reproductive toxicity. Chemicals and elements on this list include wood dust, brass, and other everyday substances, which can be found in very common household items, such as: lamps, tableware, jewelry, crystal glasses, electric cords, beauty products, automobiles, and furniture.

### Why Did I Find a Proposition 65 Warning on My Home Goods Product?

We include Proposition 65 warnings on all of our products because there is always a chance that one of the 800-plus common chemicals and ingredients listed under this law could potentially be on our furniture or packing materials. We risk large fines under this law, if we don't include this warning.

### Should I worry?

We realize you may be worried finding this warning on our products, but we want to reassure you that the hazardous exposure limits for any of these chemicals have never been found on furniture products that we've shipped to our customers. Additionally, this warning label is very common and can be found on almost every piece of furniture sold in the state of California.

### Just How Common Are Proposition 65 Warnings?

Proposition 65 warnings have become so common in California that it is hard to take a trip to a local bank, grocery store, or restaurant without finding at least one warning. In fact, even the Disney Land Resort has a Proposition 65 warning:

