

Installation Manual of Trim Kit

For EFB Series

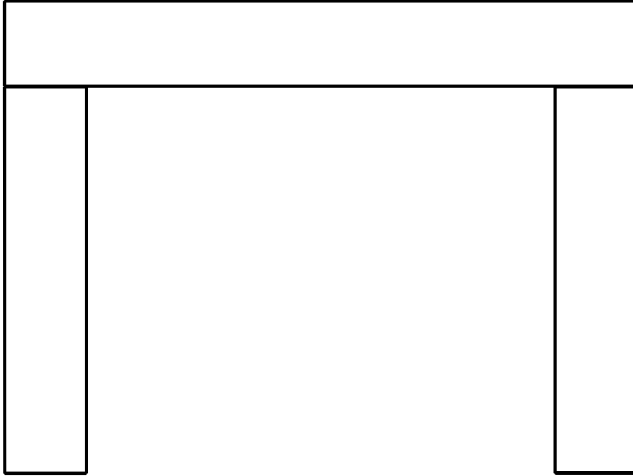

Contact our customer service team for help.

Call: 1-302-281-1886

Email: kentsky@kentskyhp.com

SAVE THESE INSTRUCTIONS FOR FUTURE REFERENCE.

1. PRODUCT DIMENSIONS

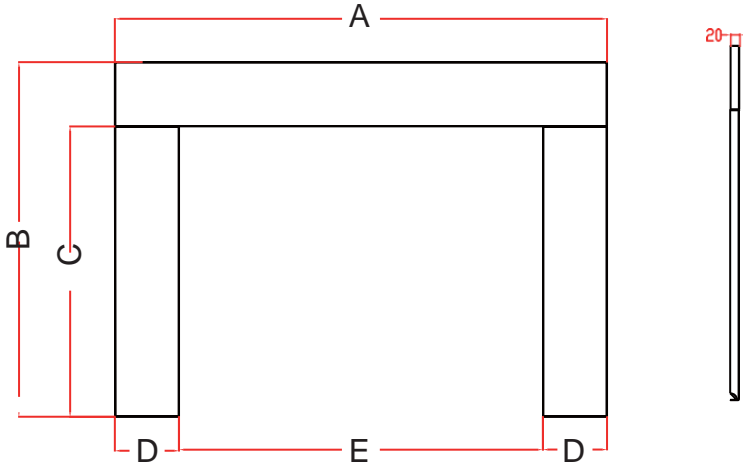

Trim Kit for	Unit	A	B	C	D	E
EF28B	mm	1002	750	602	147.5	707
	inches	39.4	29.5	23.7	5.8	27.8
EF30B	mm	1065	750	602	147.5	770
	inches	41.9	29.5	23.7	5.8	30.3
EF33B	mm	1132	816	668	147.5	837
	inches	44.5	32.1	26.3	5.8	33.0
EF33WB	mm	1132	653	505	147.5	837
	inches	44.5	25.7	19.9	5.8	33.0

2. PART LIST

A.

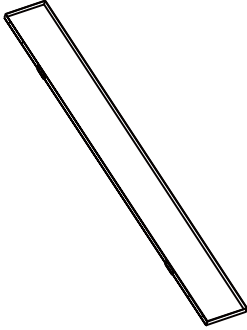

Top Panel(1PC)

B.

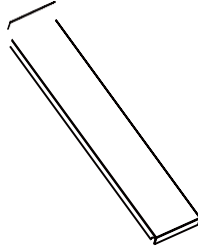

Right Panel(1PC)

C.

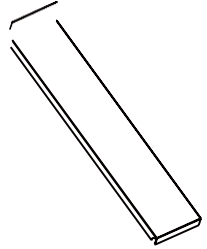

Left Panel(1PC)

D.

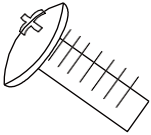

Screw M4*8(4Pcs)

E.



Spring Washer(4Pcs)

F.

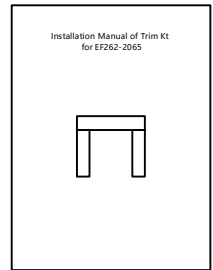

Manual(1PC)

3. INSTALLATION

Tools Required

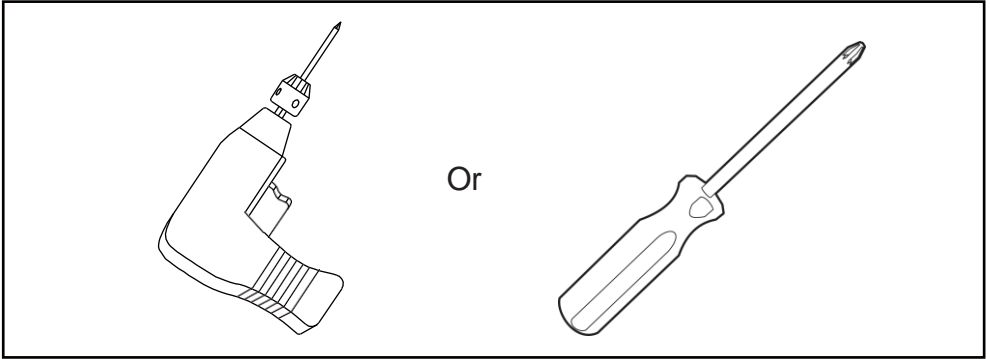

STEP 1

Use four screws to secure the top panel to the left and right side panels.

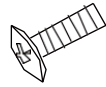
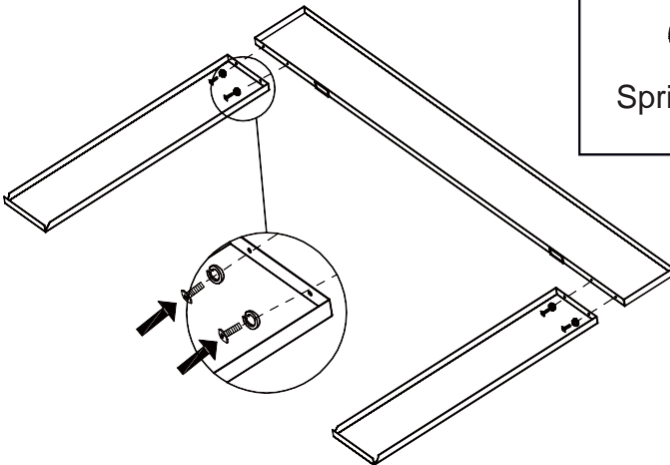

M4*8 X 4 pcs



Spring Washer
(4pcs)

STEP 2

Load the assembled Trim from the top and attach the magnet to the top of the Fireplace.

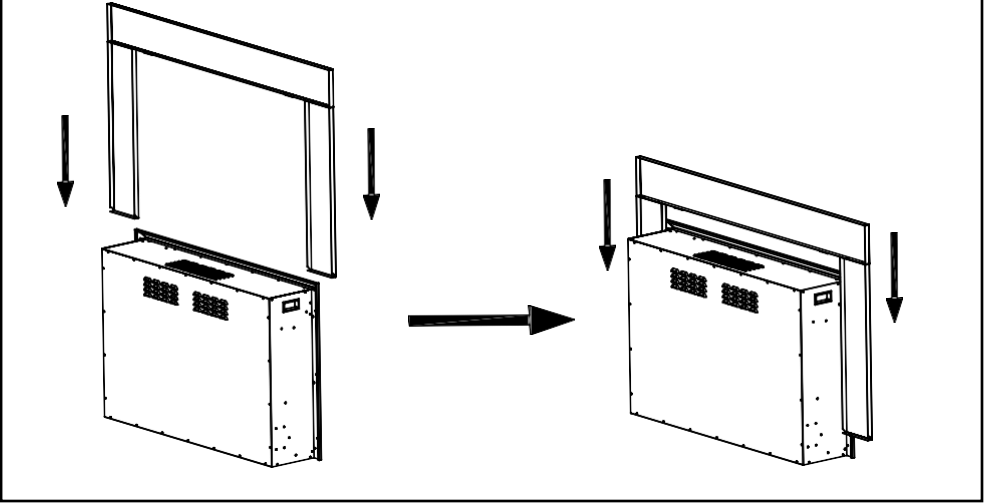

Finish Installation

