

# ASSEMBLY INSTRUCTIONS

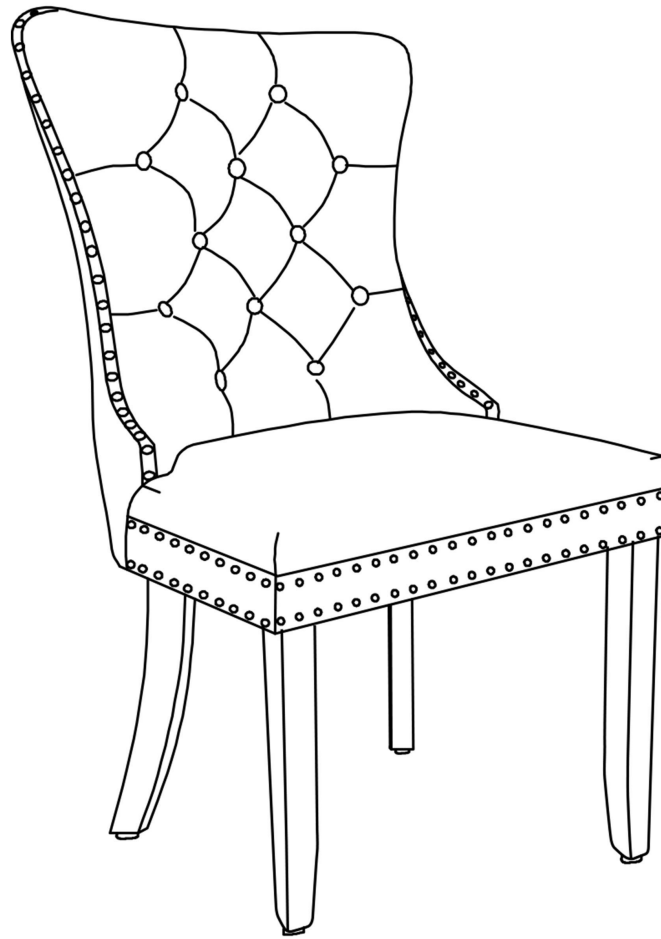

## WARNING



Please read the instructions carefully and follow the assembly steps.

Do not tighten bolts or screws completely until all hardware is lined up and inserted into the holes.

Do not over-tighten screws and bolts to avoid stripping the hardware or cracking the item.

Assemble your item on a flat, carpeted area, with plenty of space to work. This will prevent damage and scratches to your floors or the item while you're assembling the product.

Keep all components and packaging out of reach of children or animals to avoid risk of choking or suffocation.

## ASSEMBLY PARTS AND TOOL



**BEFORE YOU GET STARTED. A FEW POINTERS:**



Please open the Seat Cushion bottom and take out all accessories before installation.



Please use the included wrench instead of an ELECTRIC HAND DRILL in case of damage to the chair leg.

**A**



Backrest \*1

**S**



Seat \*1

**B**



Front leg \*2

**C**



Rear leg \*2

**D**



Adjust cap \*4

**E**



Screw \*11

**G**



Spring washer \*11

**H**



Flat washer \*11

**K**



Allen key \*1

**L**



Screw \*1





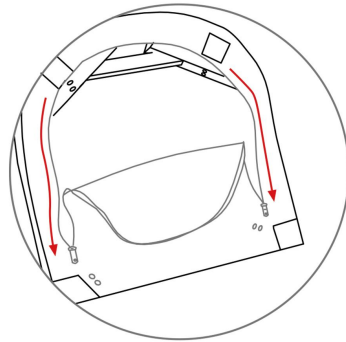

## ASSEMBLY INSTRUCTIONS

### STEP 1:



The legs are hidden under the seat frame.

### STEP 2:

- A**  Backrest \*1
- S**  Seat \*1
- K**  Allen key \*1
- E**  Screw \*11
- G**  Spring washer \*11
- H**  Flat washer \*11

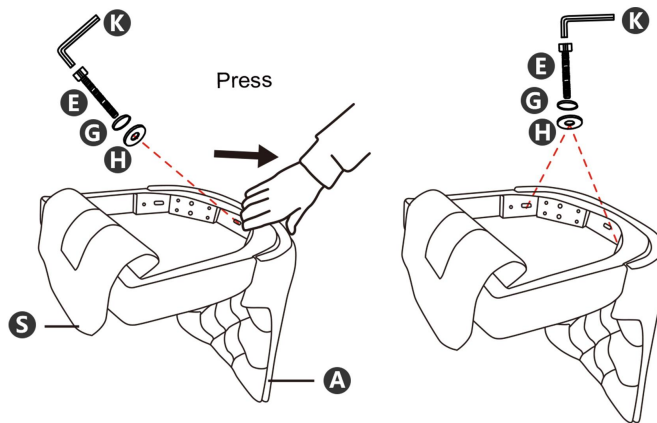

First install the central screw and tighten it to 70%, then install the screws on both sides and tighten them to 80%.

**STEP 3:**

**C**



Rear leg \*2

**K**



Allen key \*1

**E**



Screw \*11

**G**



Spring washer \*11

**H**



Flat washer \*11

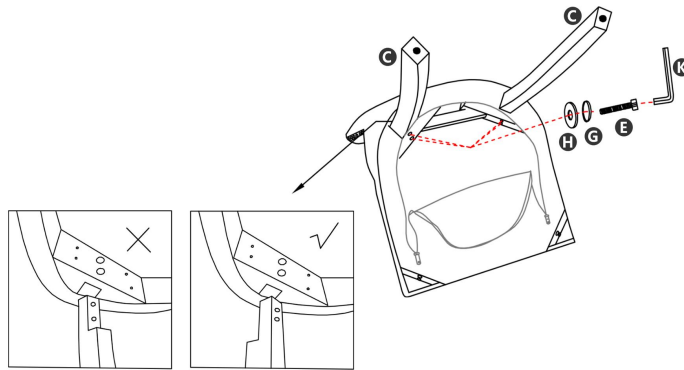

Tighten all the screws to 80% of maximum tightness.

**STEP 4:**

**B**



Front leg \*2

**K**



Allen key \*1

**E**



Screw \*11

**G**



Spring washer \*11

**H**



Flat washer \*11

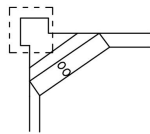

Put the front leg in the dotted box place, if you put it in the wrong place, it still can work, but the uneven force will cause the leg to break.

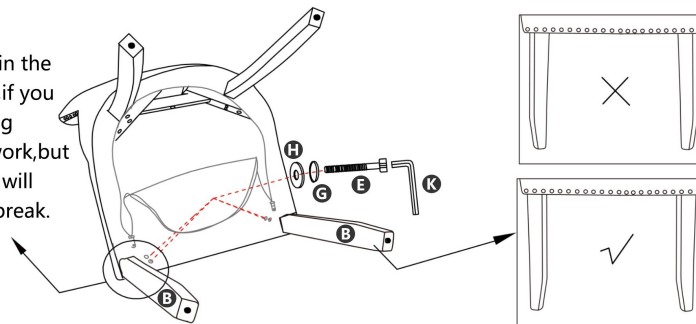

Tighten all the screws to 80% of maximum tightness.

**STEP 5:**

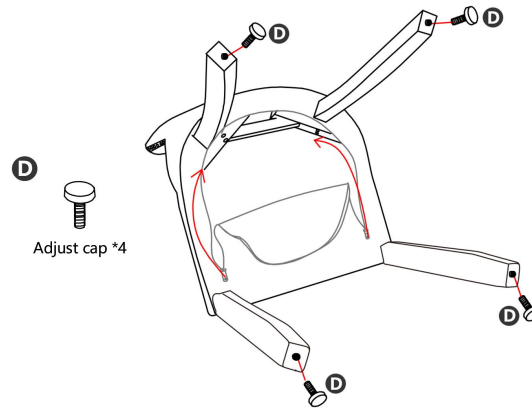

- 1.Screw D into legs.
- 2.Carefully sit on the chair and make adjustments to ensure the legs are flat even on the floor.
- 3.Tighten all the screws to 100% of maximum tightness.
- 4.Close the zipper of bottom Non-Woven fabric.

**STEP 6:**

There are 4 small adjusters on the legs, ensure these are adjusted so the chair sits level.

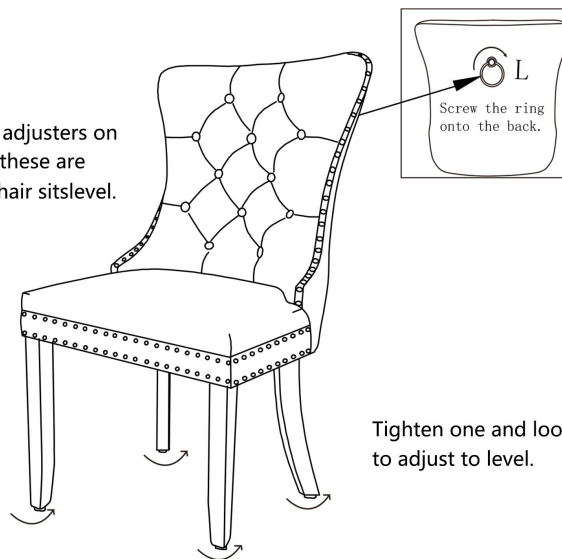

Tighten one and loosen the other, to adjust to level.