

# DINING CHAIR

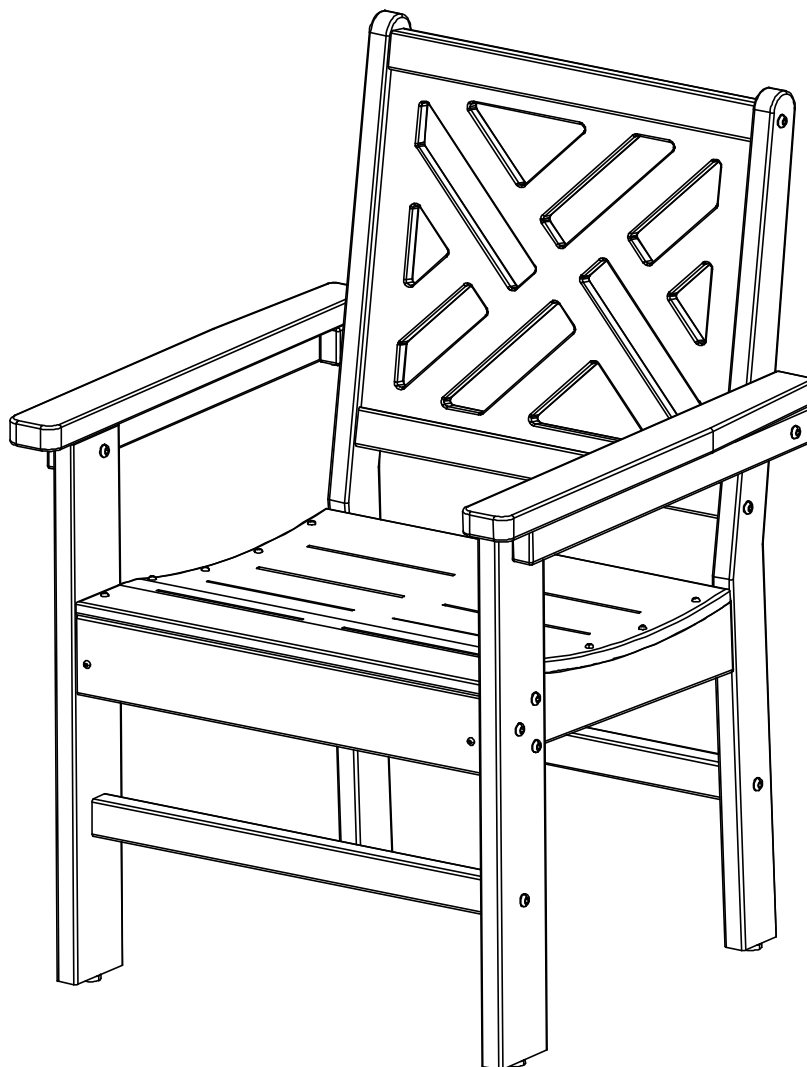

**INSTALL MANUAL**

**MATERIAL:HDPE**

---

## **IMPORTANT NOTICE**

### **We recommend 1 or more people to install.**

- **CHOKING HAZARD -- Small parts. Not for children under 3 yrs.**
- **We recommend wearing protective gloves.**
- **Do not stand on or use any part of this item as a step ladder.**
- **Firmly secure all bolts, screws and knobs before use.**
- **Reconfirm that all bolts, screws, and knobs are secure every 90 days.**
- **Fasten screws loosely during initial assembly. Do not firmly tighten the screws until the item incompletely assembled.**
- **Keep away from fire or other heat sources.**
- **Be aware that some parts are heavy and have sharp edges.**
- **Please follow the instruction manuals and use a pad to avoid damage during assembly**

# PARTS LIST

**1** x 1pc

Backrest

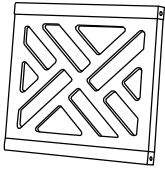

**2** x 1pc

Left hind leg

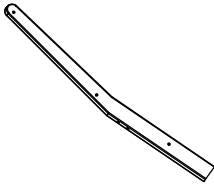

**3** x 1pc

Right hind leg

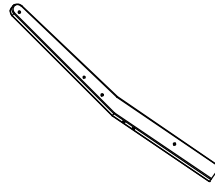

**4** x 1pc

Seat

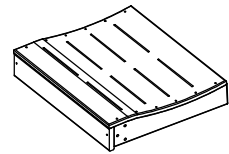

**5** x 2pcs

front leg

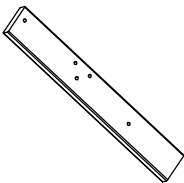

**6** x 1pc

left handrail

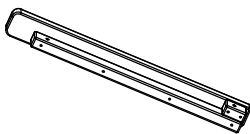

**7** x 1pc

right handrail

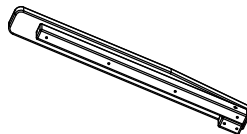

**8** x 1pc

Front Rail

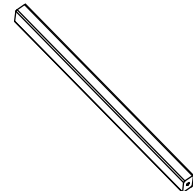

**9** x 1pc

Back Rail

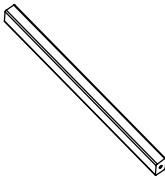

# HARDWARE LIST

**A** x16+1pcs

M6 x 40mm



**B** x2pcs

M6 x 70mm



**C** x4pcs

M6 x 80mm

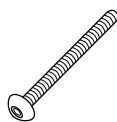

**D** x1pc

Allen Wrench



**E** x4pcs

Leveling Feet

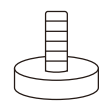

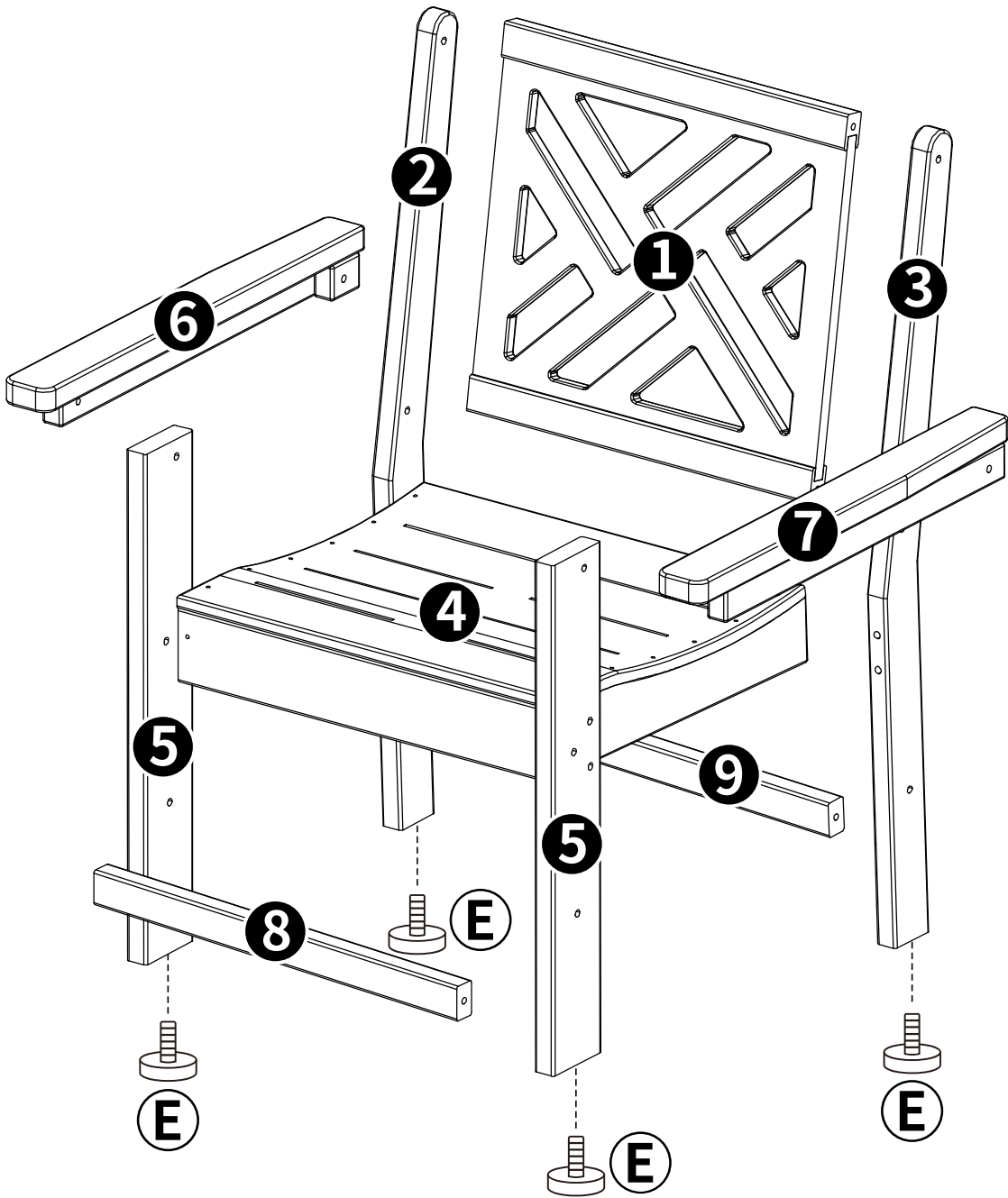

**Weather  
Resistant**



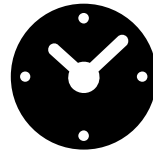

**350 LBS  
Load-bearing**



**Install  
Quickly**

# STEP 1

- A  x 4
- D  x 1

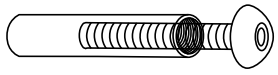

Tighten the screws to 80%, not fully.

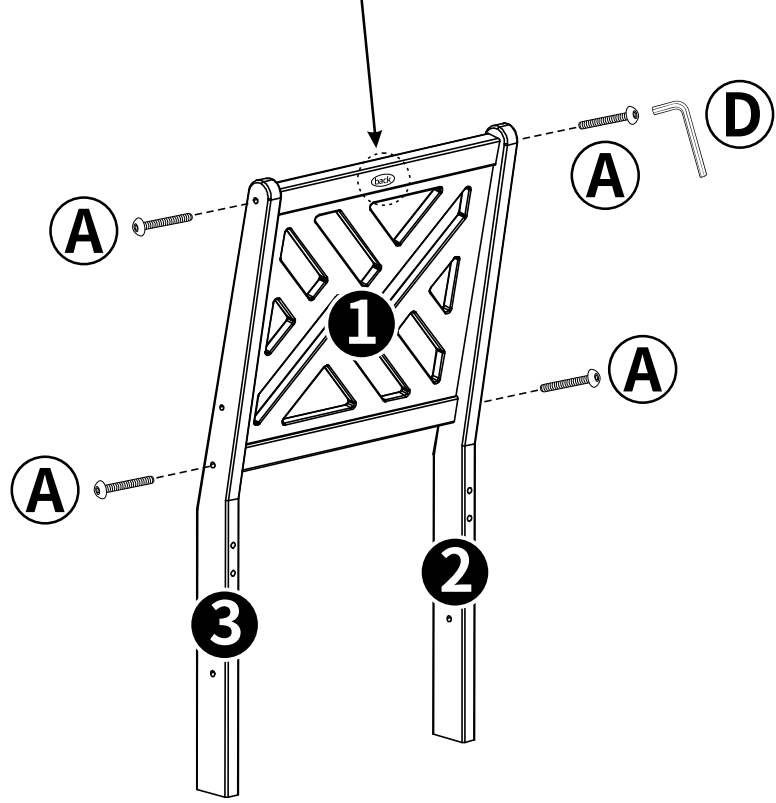

Note: The back of the label



# STEP 2

- C  x 4
- D  x 1

Tighten the screws to 80%, not fully.

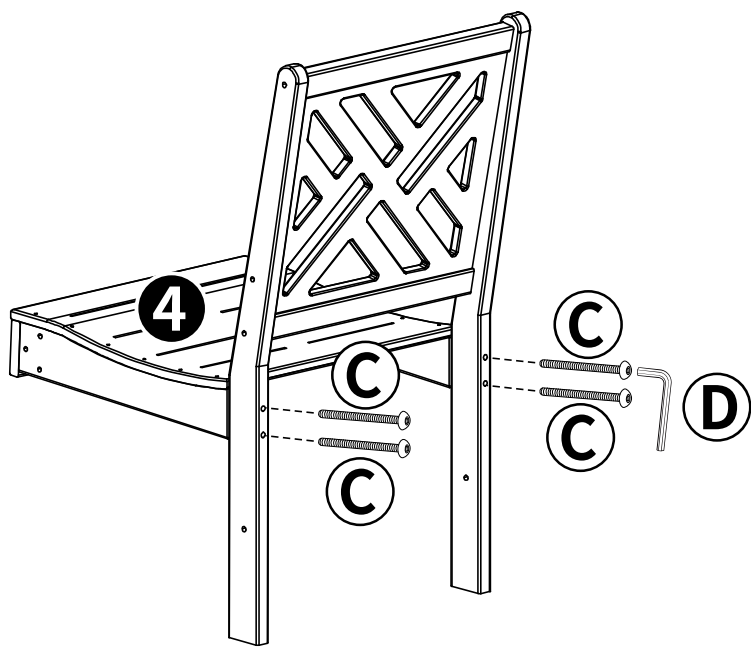
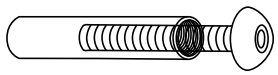

## STEP 3

A  x 6

D  x 1

Tighten the screws  
to 80%, not fully.

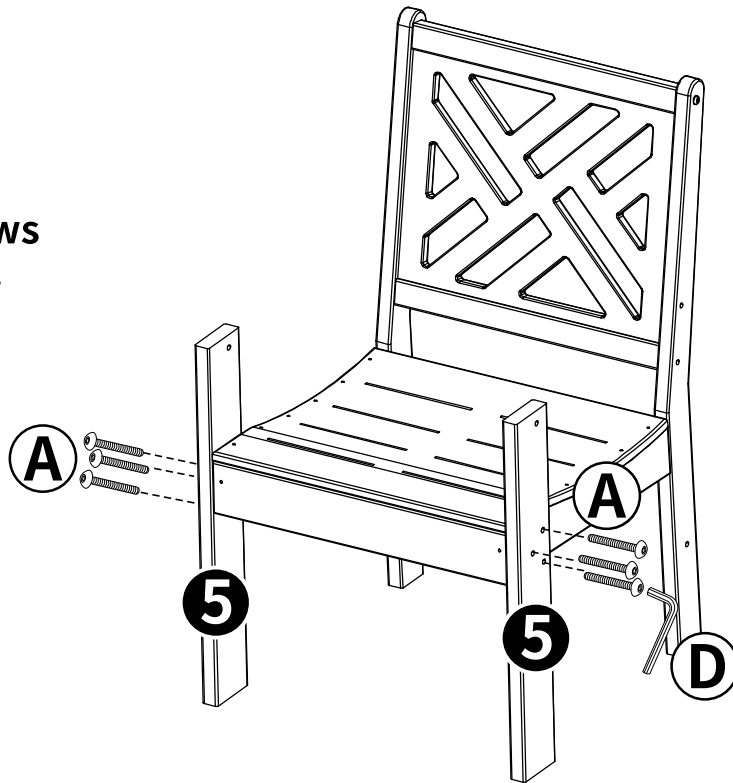
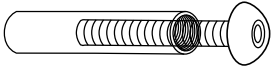

## STEP 4



A  x 2

B  x 2

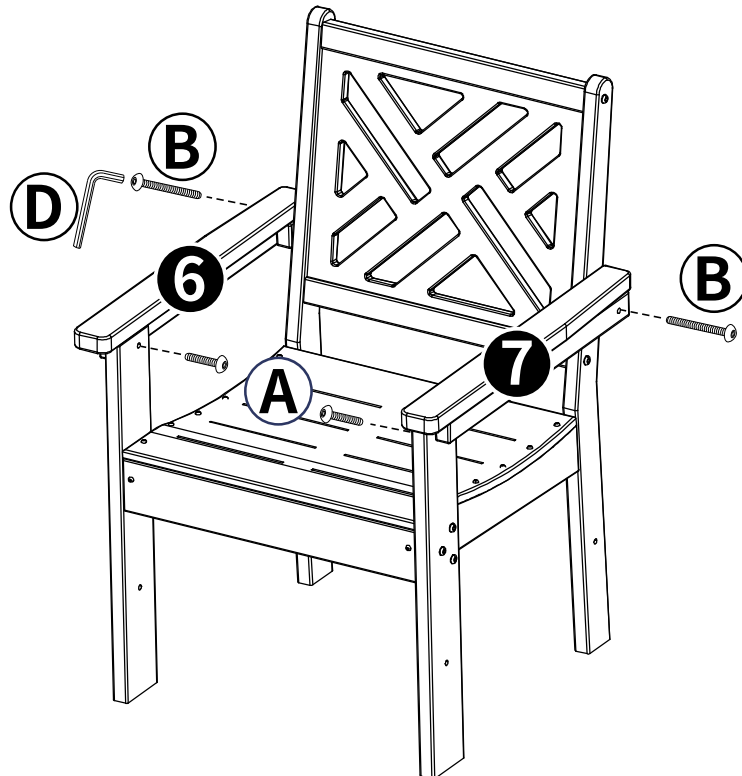
D  x 1



# STEP 5

- A  x 4
- D  x 1

Tighten the screws to 80%, not fully.

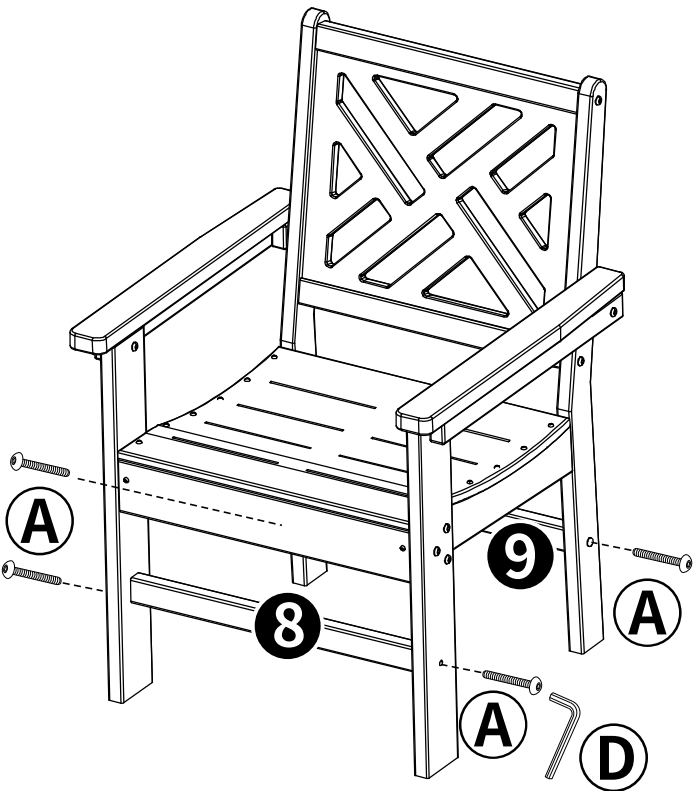
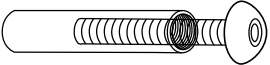

# STEP 6

- E  x 4

Tighten the screws to 80%, not fully.

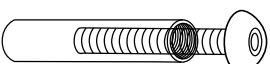

# FINISHED

Tighten all screws fully in step 123456

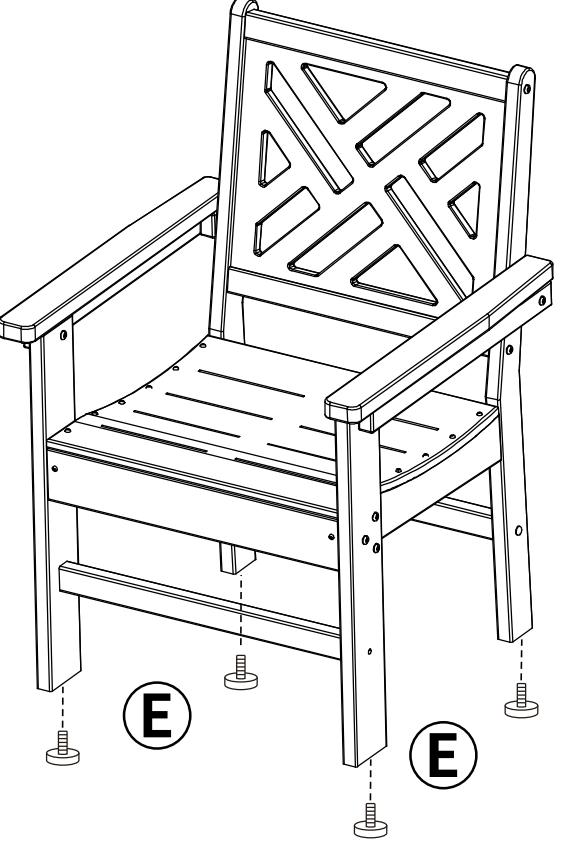
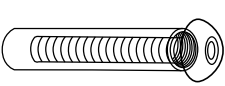

**If you are not entirely satisfied with your purchase, please feel free to contact us.**

Using the following steps:

1. Go to Your Orders.
2. Find your order in the list.
3. Select Problem with order.
4. Choose your topic from list displayed.
5. Select Contact seller.

**You can also download the PDF Installation Manual from the Product guides and documents section of the advertising page.**