

9

10

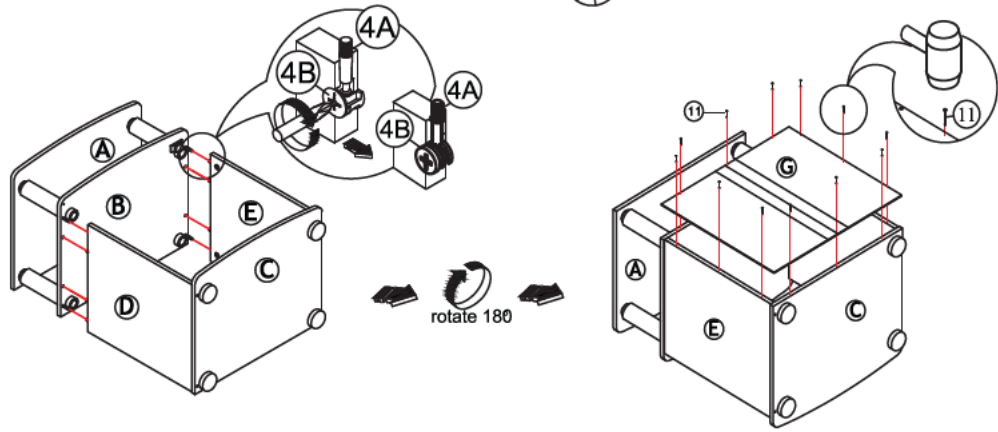

11

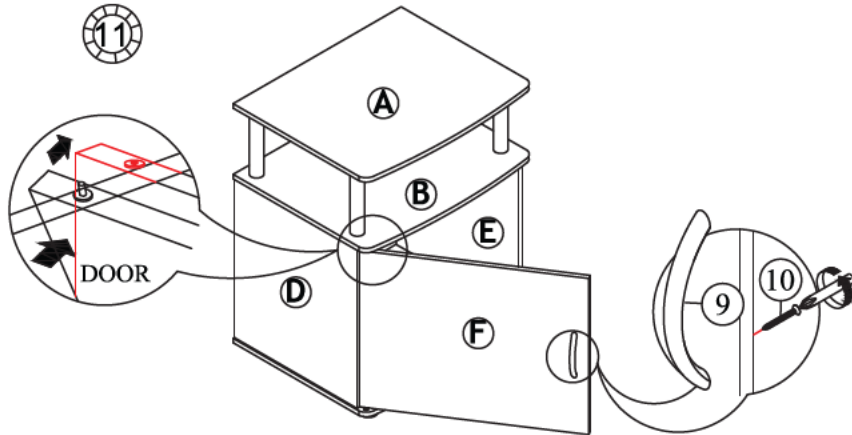

Recommended Maximum Weight

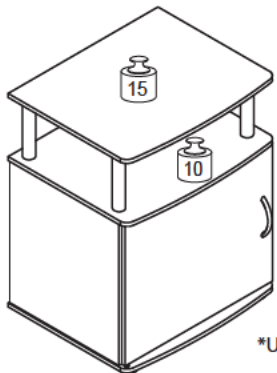

*Unit in Pound(lbs)

WARNING:

>This unit has been designed to support the maximum loads shown. Exceeding these load limits could cause sagging, instability, product collapse, and/or serious injury.

>DO NOT allow children to climb on unit.

>Put heavier items on lower shelves.

Assembly Instruction

End Table / Side Table

00:30

Approx. 30 minutes





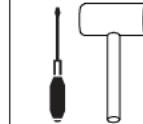



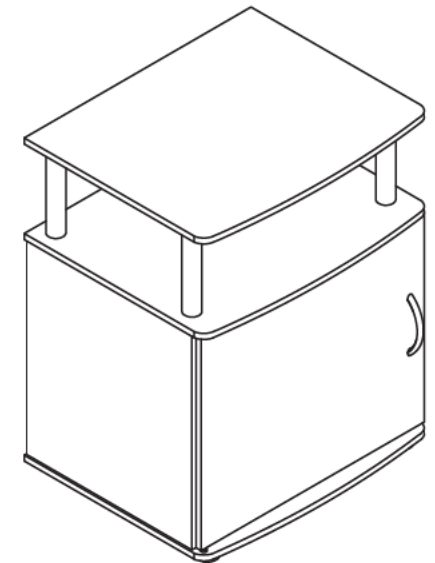







Recomm. 2 Person



Tool Required



No	Parts List	Qty
A	TOP PANEL	1pc
B	CENTER PANEL	1pc
C	BOTTOM PANEL	1pc
D	LEFT SIDE PANEL	1pc
E	RIGHT SIDE PANEL	1pc
F	DOOR PANEL	1pc
G	BACK PANEL	1pc

No	Hardware List	Qty
1	SHORT ROUND POLE 	4pcs
2	MINI ROUND LEG 	4pcs
3	PVC LEG WITH PLUG 	4pcs
4	MINI FIX + HOUSING 4A  4B 	4sets
5	DOWEL 	8pcs
6	C/B SCREW A 	4pcs
7	MAGNET 7A  7B 	1set
8	DOOR SPRING SUPPORT 	2pcs
9	HANDLE 	1pcs
10	C/B SCREW B 	2pcs
11	POWER PIN 	12pcs
12	PVC ROUND RING 	4pcs

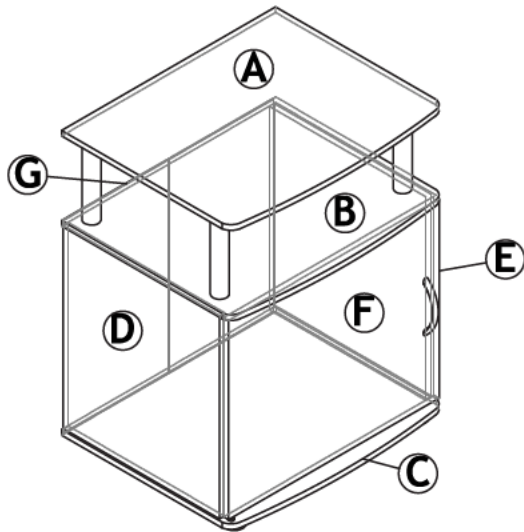

USEFUL HINTS BEFORE YOU START:

1. Read each step carefully before starting.
2. It is important that each step is performed in correct order to avoid difficulties.
3. Identify, sort and count the parts before assembly.
4. Assemble your furniture on packaging cardboard to prevent scratch or damage.
5. Clean the product with mild cleanser using soft damped cloth. Do not use harsh or abrasive cleanser.
6. Using incompatible hardware might cause damage to product.

