

ASSEMBLY INSTRUCTIONS

Hanging Hammock Flying Saucer with Stand



FlowerHouse[®]

www.flowerhouses.com (810) 686-8252

INTRODUCTION

Thank you for purchasing the Hanging Hammock Flying Saucer with Stand! We have designed this hammock for maximum comfort and safety. Please read this document carefully when assembling (you are ultimately responsible for your safety).

FEATURES

Decorative Frame
Single-point Hanger
Strong Straps
Comfortable Swaying Saucer Hammock
Two drink holders
Bug Net
Camping Cover

SPECIFICATIONS

Assembled Height = 8ft. (2.4m.)
Assembled Width = 5-1/2ft. (1.6m.)
Weight = 95lbs. (43kg.)

WARNING

Follow these warnings to ensure your safety while using this hammock:

- This product is NOT a trampoline or a toy - it is only for adult resting.
- Do not allow more than two adults to sit on (weight limit is 400lbs.).
- Be sure to install the hammock base on a level, floor or outdoor surface.
- Never stand on the hammock and do not climb or hang from the frame.
- Stay within the saucer and never spin the saucer when using.
- Do not use the hammock in high winds.
- Do not exit the saucer unless BOTH feet are planted firmly on the ground.
- Always inspect joints periodically and tighten any loose bolts.
- If any damage or fraying is found during inspection, immediately remove from service.
- Do not leave in the sun and weather for prolonged periods (exposure can damage fabric).
- Never store any hazardous materials inside the hammock.
- Do not position the hammock close to a camp fire or open water.

PARTS LIST

Be sure to check that all parts of the chair have been shipped below:

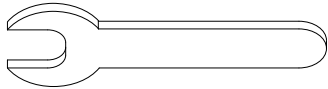

**Crescent
Wrench (1)**

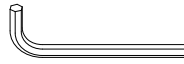

**Small Hex
Wrench (1)**



**Large Hex
Wrench (1)**

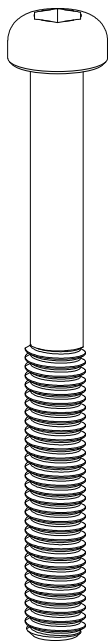

**Long Black Round
Head Bolt (1)**

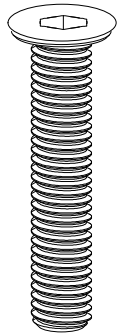

**Medium Silver Flat
Head Bolt (3)**

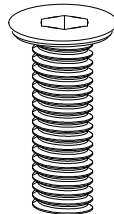

**Short Silver Flat
Head Bolt (6)**

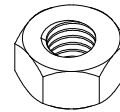

**Large
Nut (8)**



**Small
Nut (9)**



Carabiner (1)

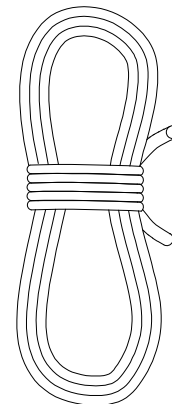

Rope (1)

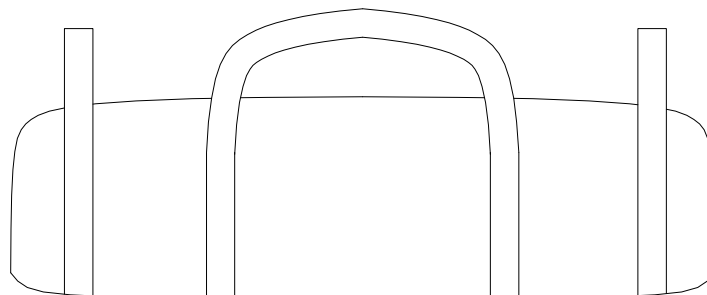

Carry Bag (1)

PARTS LIST (cont.)

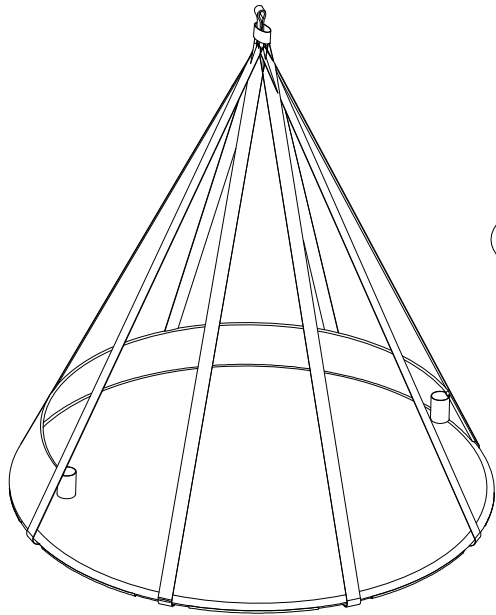

Saucer (1)

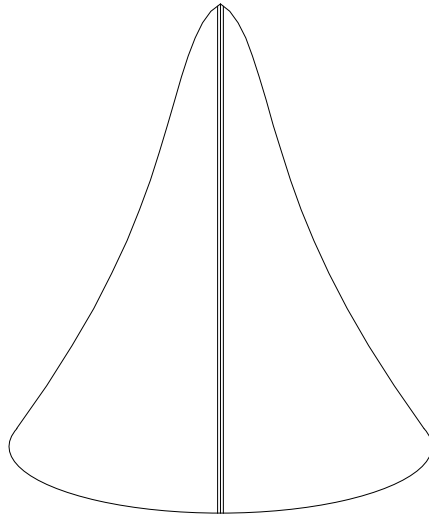

**Camping
Cover (1)**

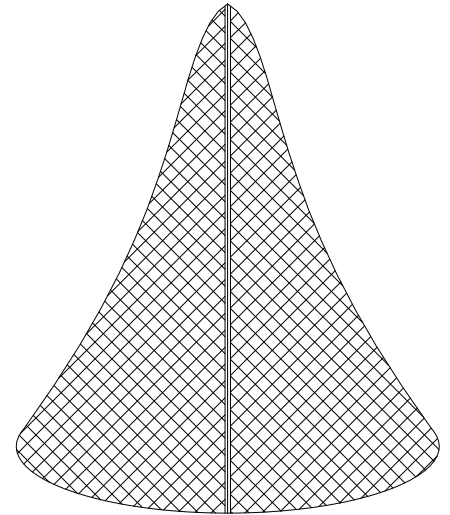

Bug Net (1)

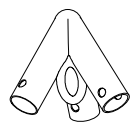

**Tripod
Top (1)**



**Saucer
Poles (8)**



**Curved
Base
Poles (9)**



**Curved
Arms (3)**



**Straight
Arms (1)**

ASSEMBLY

The Hanging Hammock Flying Saucer with Stand requires a lot of room to assemble - consider assembling in a large area inside or ideally assemble outdoors.

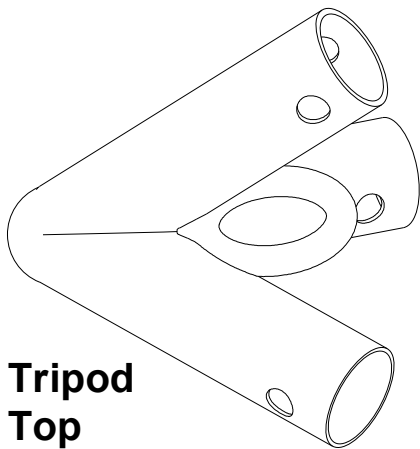

1 Lay **TRIPOD TOP** on the floor as shown.

Curved arm

Straight arm

2 Insert **STRAIGHT ARMS** and **CURVED ARMS** into **TRIPOD TOP**.

Straight arm

Tripod Top

3 Attach **STRAIGHT ARMS** and **CURVED ARMS** with **LONG BLACK ROUND HEAD BOLTS** and **LARGE NUTS**.

ASSEMBLY (cont.)

4

Lift frame up. Slide **CURVED BASE POLES** into sleeves on bottom of **CURVED ARMS**.

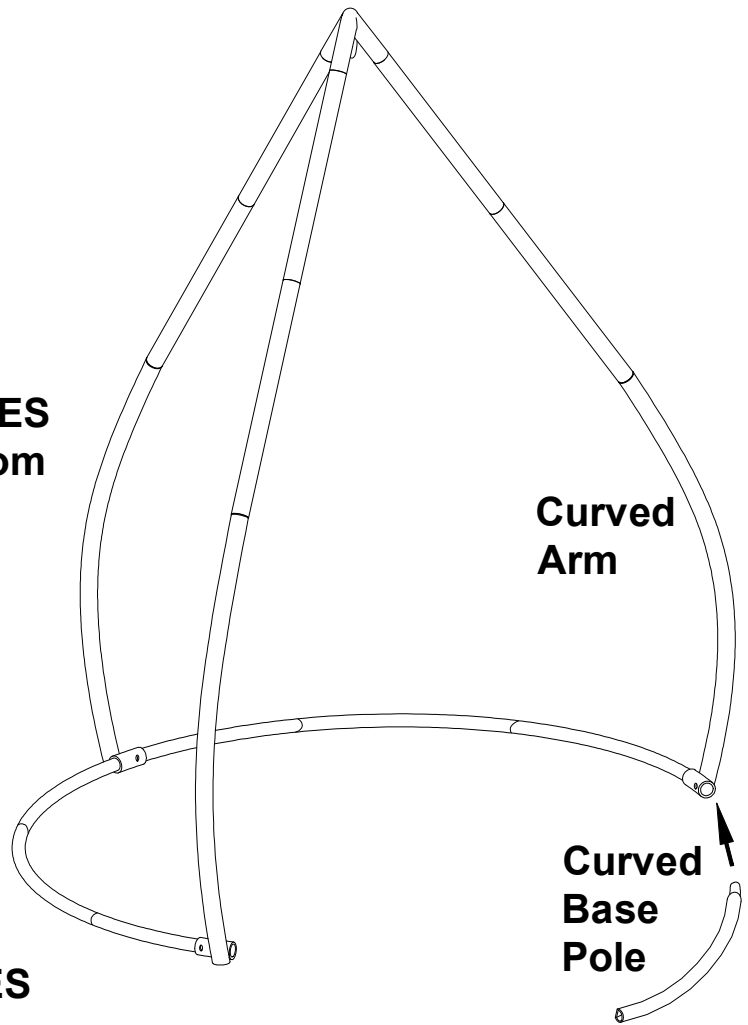

5

Insert **CURVED BASE POLES** into **CURVED ARM** sleeves.

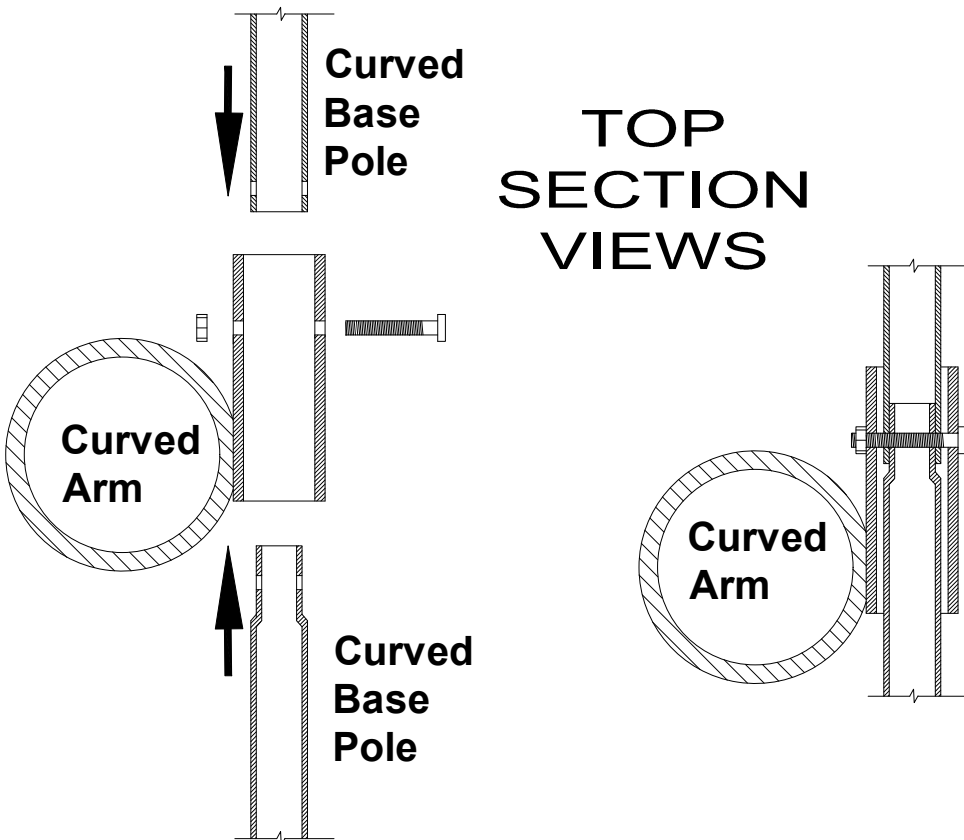

6

Align all **SAUCER POLE** holes with **CURVED ARM** holes and insert **Medium Silver Flat Head Bolts** and nuts.

ASSEMBLY (cont.)

7 Remove any end caps on SAUCER POLES and slide them into sleeves on bottom side of SAUCER.

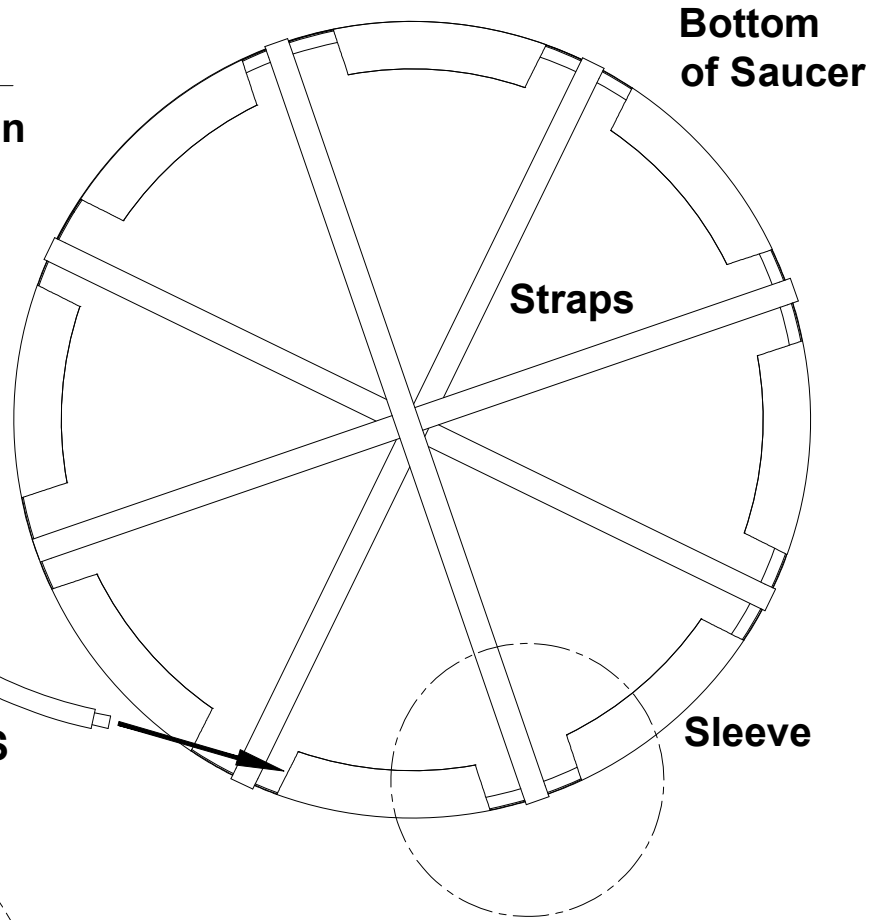

8 Pull STRAPS aside and join SAUCER POLES

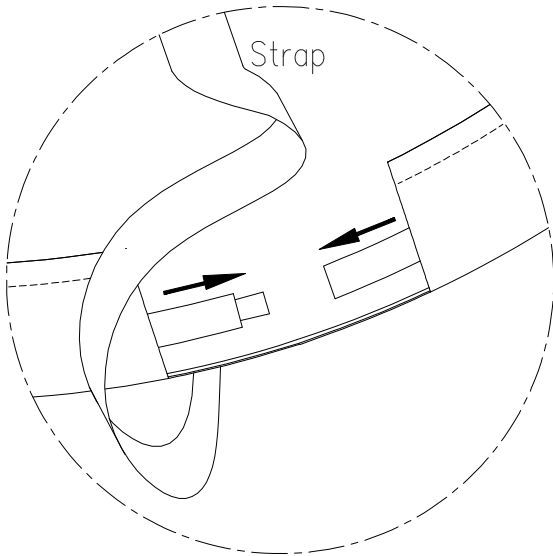

BE SURE STRAPS ARE OUTSIDE THE SAUCER POLES

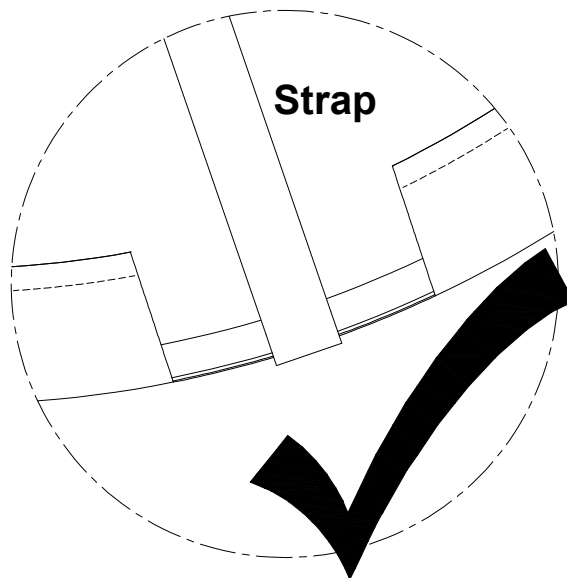
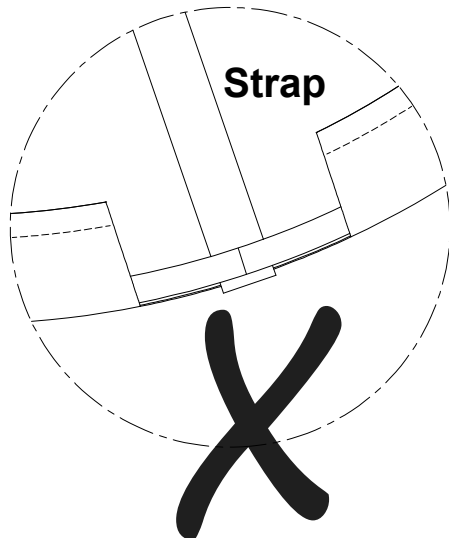

ASSEMBLY (cont.)

9

Attach CARABINEER to blue SAUCER loop, hoist SAUCER up and attach CARABINEER to TRIPOD TOP ring.

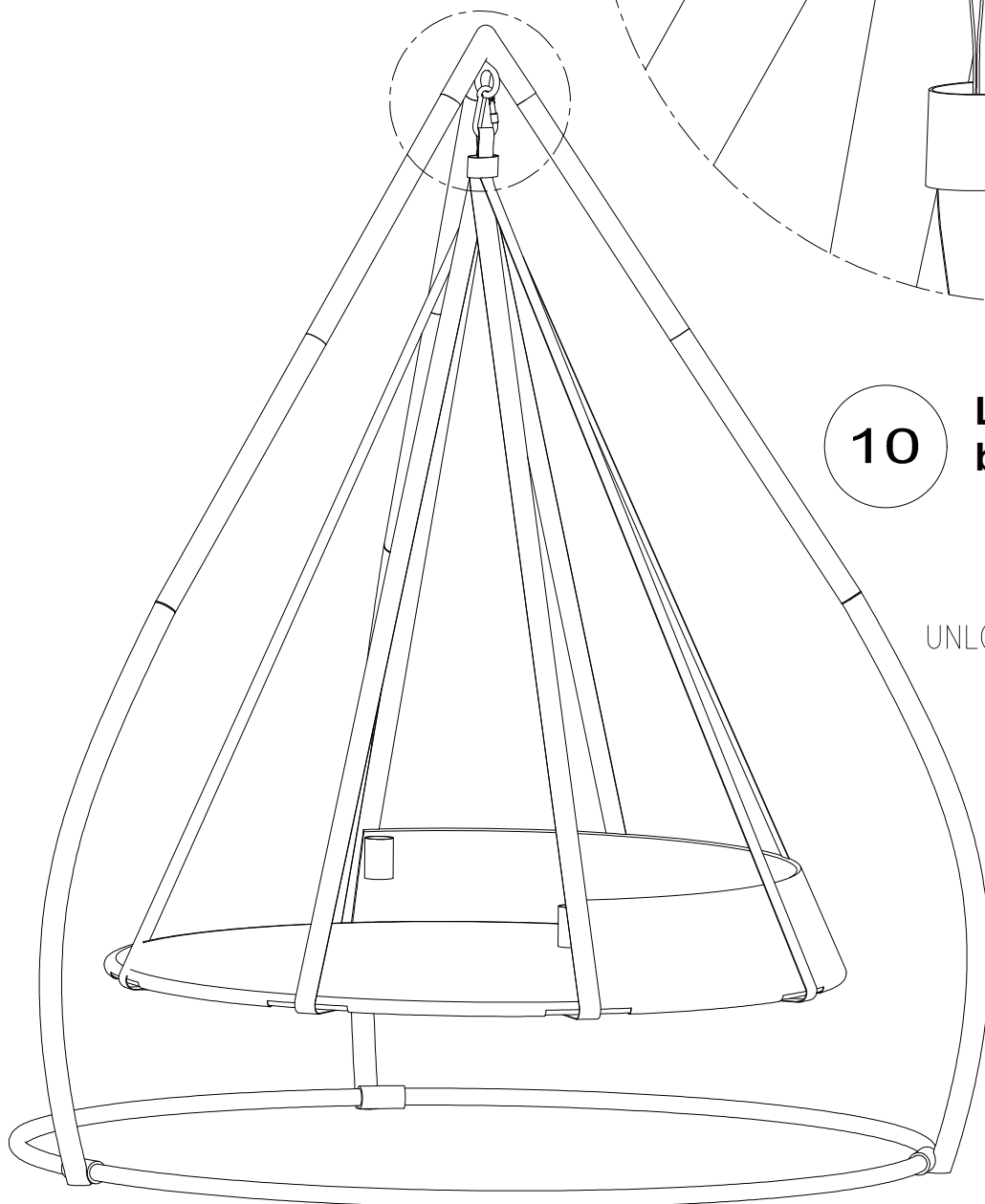
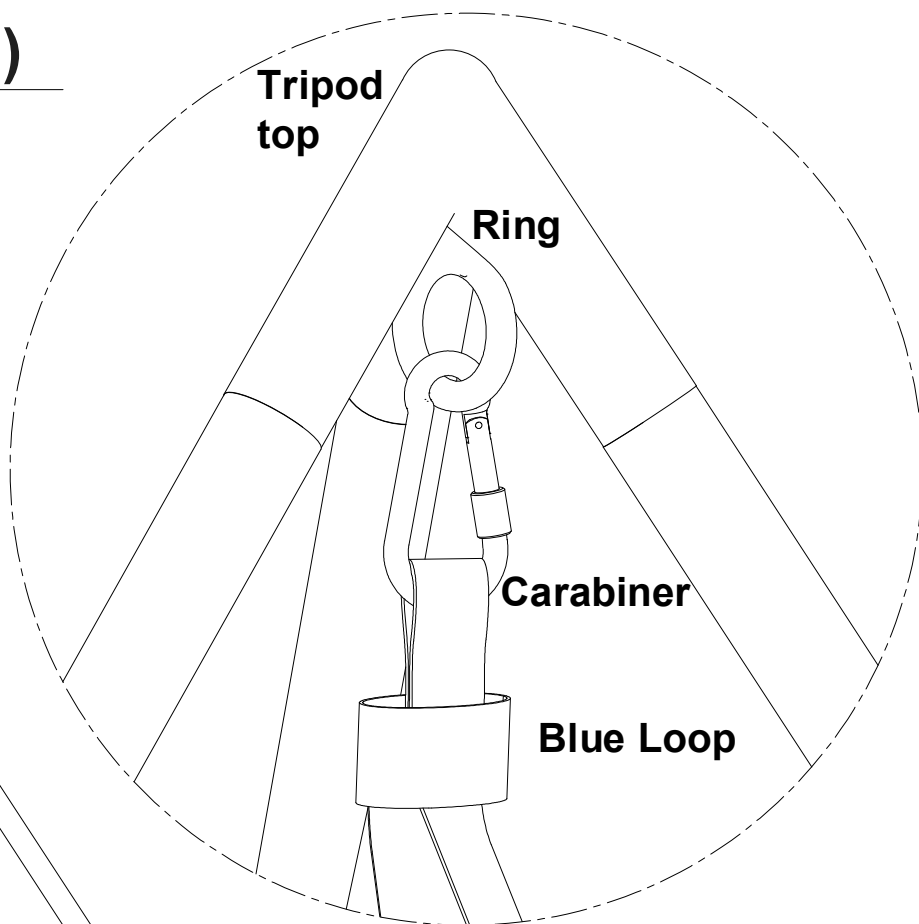

10

Lock CARABINEER gate by twisting barrel.

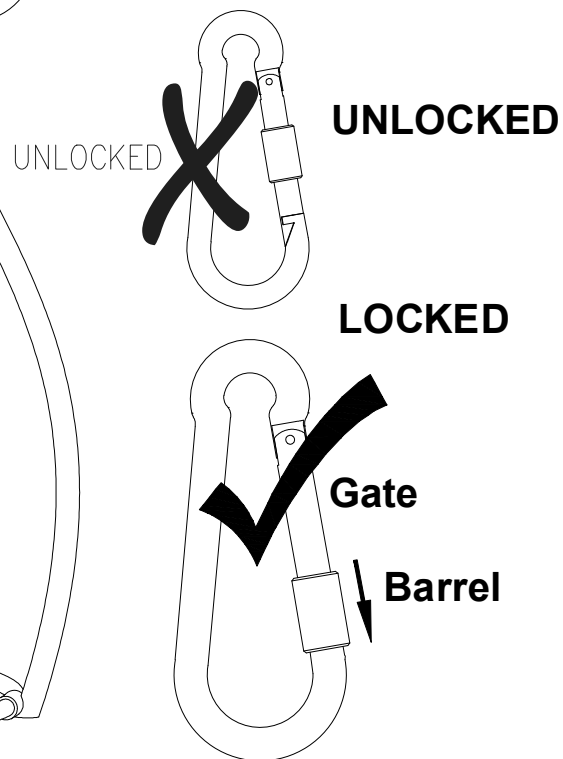

ASSEMBLY (cont.)

11

Attach **CAMPING COVER** by wrapping around **SAUCER**, feed blue strap through **LOOP**, closing zipper, and tightening draw strings.

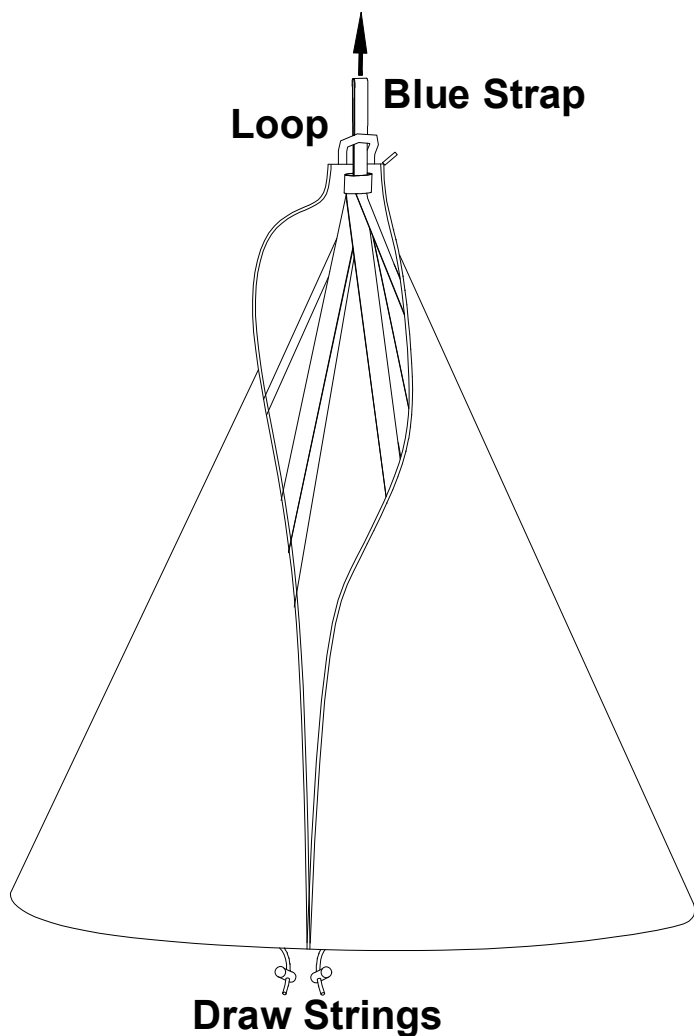

12

Attach **BUG NET** by wrapping around **SAUCER**, velcro flap over blue strap, closing zipper, and tightening draw string.

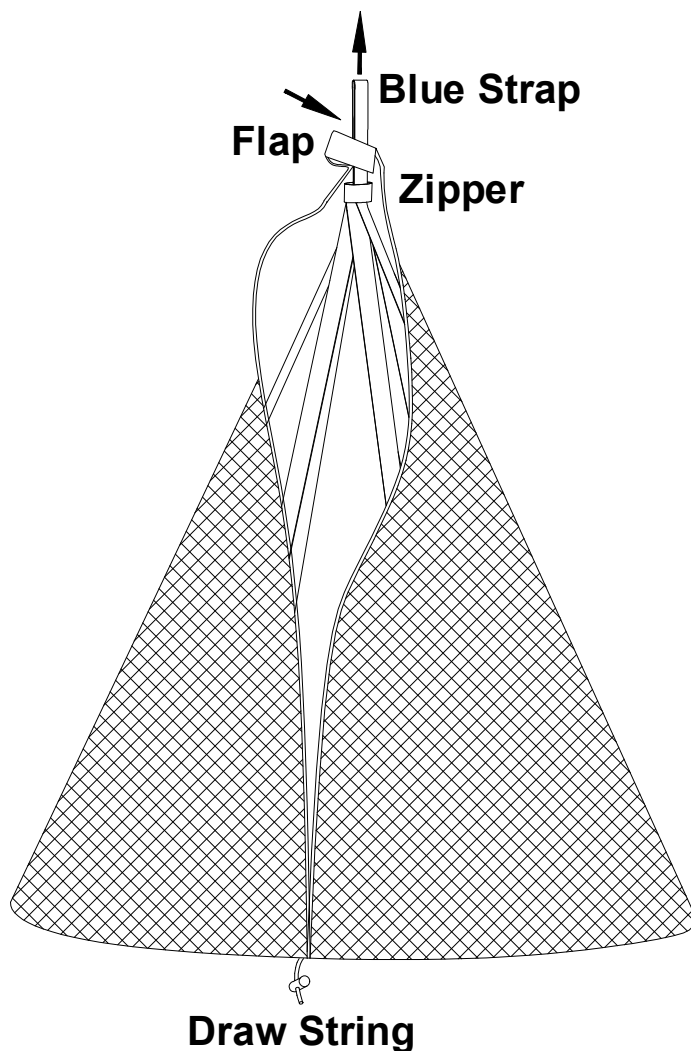

ROUTINE MAINTENANCE

Check to see that all nuts and bolts are tight - tighten if loose. If any items are cracked, torn or broken remove the product from service.

DISCLAIMER

This Manual relates solely and exclusively to the FlowerHouse Chairs and Hammocks including but not limited to the operation thereof. Failure to adhere to this manual or to properly focus on the recommended operation can result in death, serious injury and property damage. Always operate the FlowerHouse products in a safe manner and in full compliance with this manual. FlowerHouse is not liable for any injuries or damages to any operators, property or bystanders incurred as a result of using the FlowerHouse products by its customers. FlowerHouse also cannot be held liable for any and all errors in this manual or for any incidental or consequential damages that result for the use of the material presented in this manual. This manual contains proprietary information belonging solely and exclusively to FlowerHouse. All rights are reserved. No part of this manual may be photocopied, reproduced or translated to another language without the written consent of FlowerHouse. If this disclaimer is unacceptable, please return the unused product within 10 days of purchase (along with proof of purchase) for a full refund to the address below.

WARRANTY CARD

Mail return within 14 days of purchase with copy of dated register receipt to activate warranty. Please make a copy of this card for your records and mail to:

**FLOWERHOUSE
P.O. BOX 595
CLIO, MI 48420-0595**

PRODUCT MODEL NO. _____

NAME: _____

DATE OF PURCHASE: _____

ADDRESS: _____

EMAIL: _____

SIGNATURE: _____ **DATE:** _____

(my signature acknowledges that I have read, fully understand, and accept this limited warranty agreement)