



**INSTRUCTIONS D'ASSEMBLAGE
ASSEMBLY INSTRUCTIONS**

MONARCH
SPECIALTIES INC.

I 9673

**LUMINAIRE -
24"H LAMPE DE TABLE NOIR CERAMIQUE / IVOIRE**

**LIGHTING -
24"H TABLE LAMP BLACK CERAMIC / IVORY SHADE**



**POUR DE L'ASSISTANCE OU POUR COMMANDER
DES PIÈCES CONTACTEZ NOTRE DÉPARTEMENT
DE SERVICE À LA CLIENTÈLE.**

**FOR ASSISTANCE OR TO ORDER PARTS
CONTACT OUR CUSTOMER SERVICE DEPARTMENT**

WWW.MONARCHSERVICE.COM

LISTE DES PIÈCES
PARTS LIST

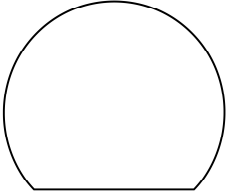
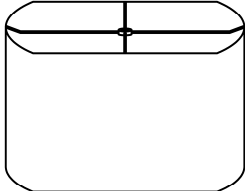
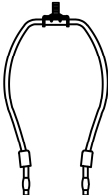
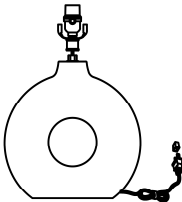
PIÈCE / PART #	IMAGE	DESCRIPTION	QTY / QTÉ
1		<p>FINIAL FAÎTEAU</p>	1
2		<p>SHADE ABAT-JOUR</p>	1
3		<p>HARP LYRE</p>	1
4		<p>LAMP BASE SOCLE DE LAMPE</p>	1

ÉTAPE / STEP 1

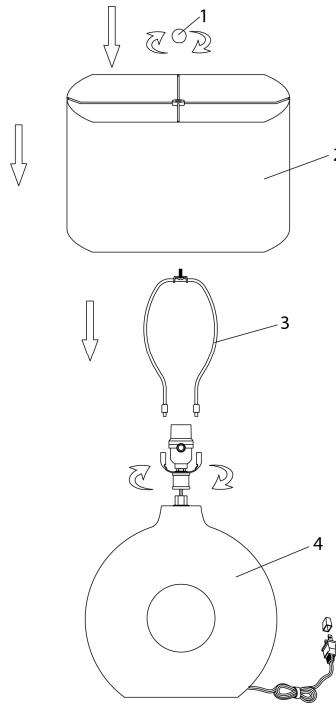

ÉTAPE / STEP 2

