

# Outdoor Large Dog Cage 10\*20ft

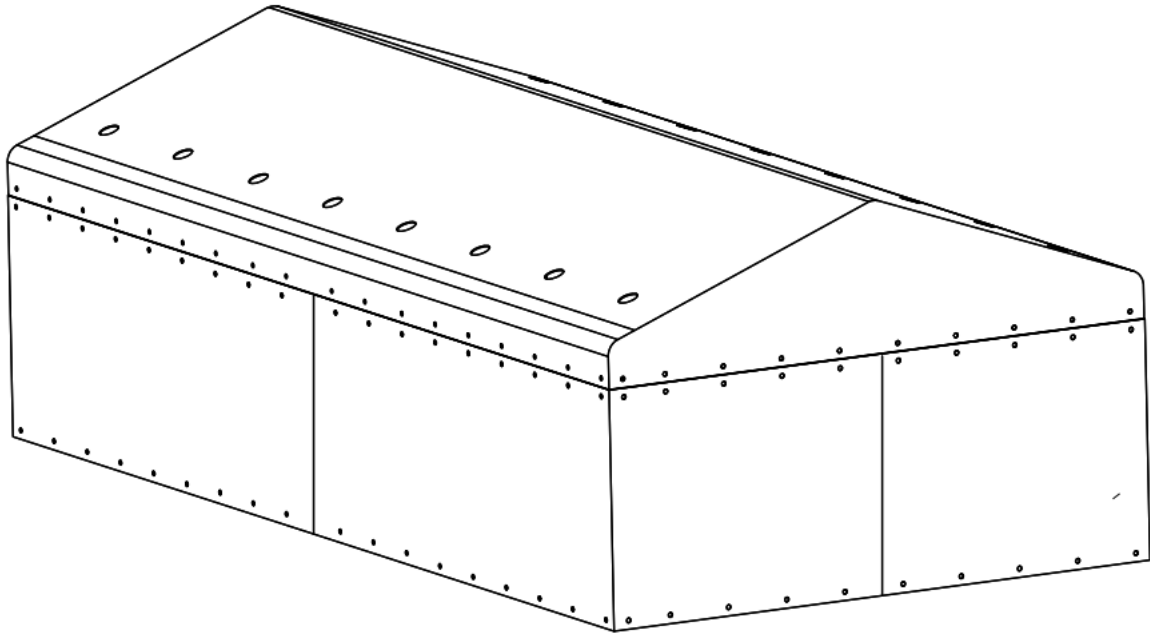

## **Thank You for Choosing !**

Our goal is to provide high quality Dog Enclosures with outstanding customer service-all at an affordable price.

Please let us know how we are doing!

## **Problems?**

We will fix it immediately.



**Service001@outlook.com**

As a valued customer, your satisfaction is our #1 priority!

## **Happy?**

Please leave us a review on Amazon!

# SPECIFICATIONS

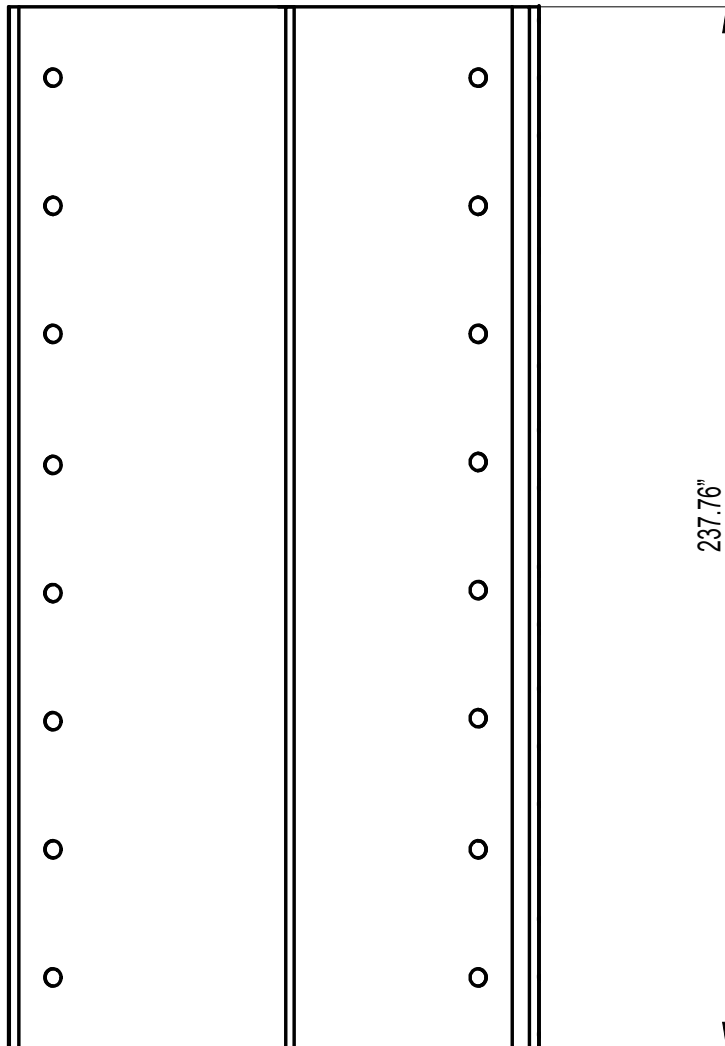
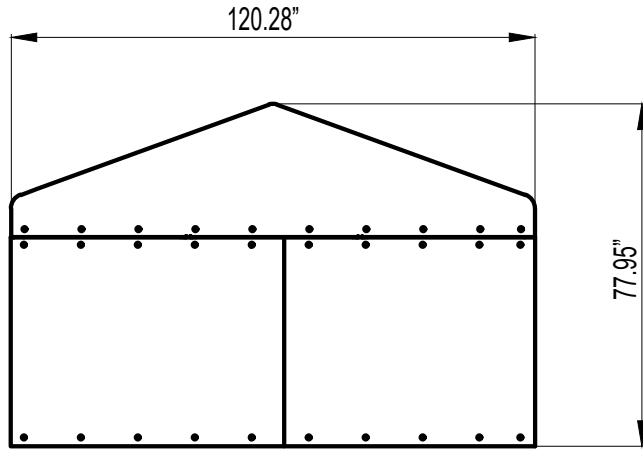

# CONTENTS

Specifications.....	1
Contents .....	2
Important.....	3
Parts List.....	4
Screw Set.....	6
Instruction.....	7

# IMPORTANT

**Note:**Please prepare below tools before installation.

The following tools are not included and needed for assembly:



Pistol Drill



Tape Measure

## Package included Tools

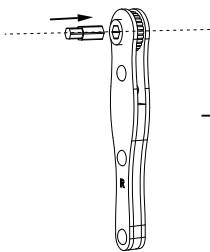

Ratcheting wrench x1



Gloves x1 pair

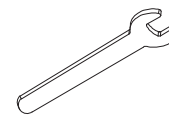

Open-end wrench x2

## Warning

We recommend two adults to complete the installation. Two adults installed together will make the installation process easier and safer.

The gloves must be carried to prevent hand cuts during installation.

Take care when using power tools near water the use of a residual current device (RCD) is advised.

Please use the electric driver carefully during screwing to prevent the screw from slipping and hurting your hand.(We recommend that beginners use a manual screwdriver for installation.)



Be careful not to fall when installing the roof. Please steady the ladder and make sure the product placed on a flat ground.

**PLEASE KEEP THIS INSTRUCTION FOR FUTURE REFERENCE.**

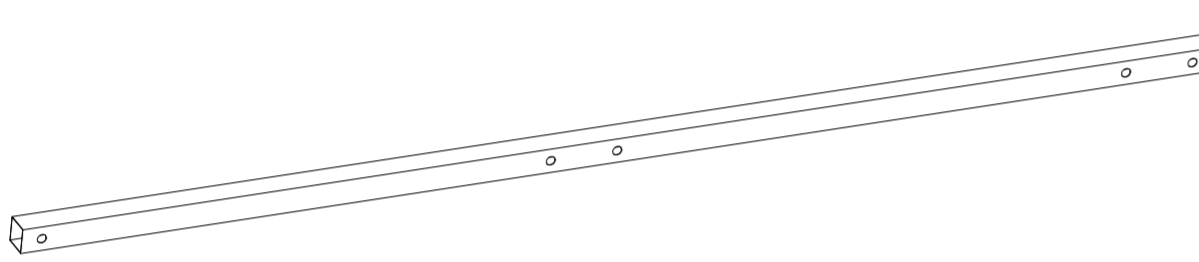
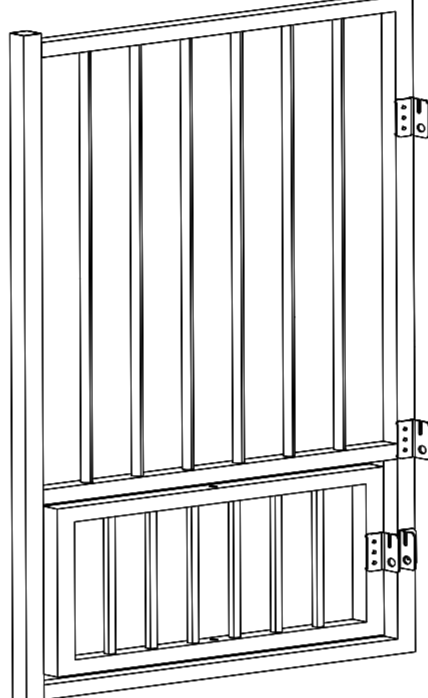
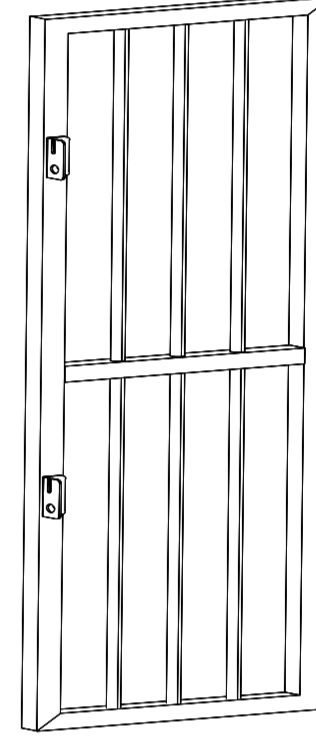

## PARTS LIST BOX OF A

<p>Ⓔ × 199</p> 	<p>Ⓖ2 × 4</p> 	
<p>Intubation</p>	<p>Dog Crate Front Cover Cloth</p>	

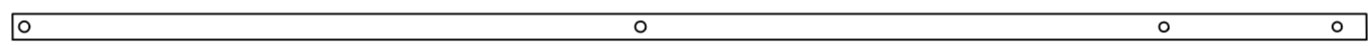
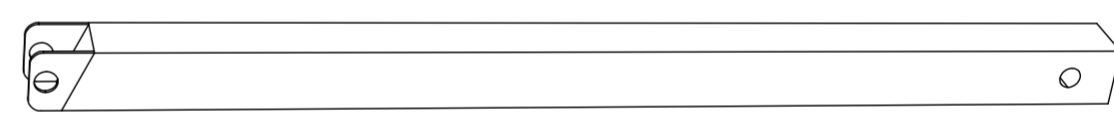
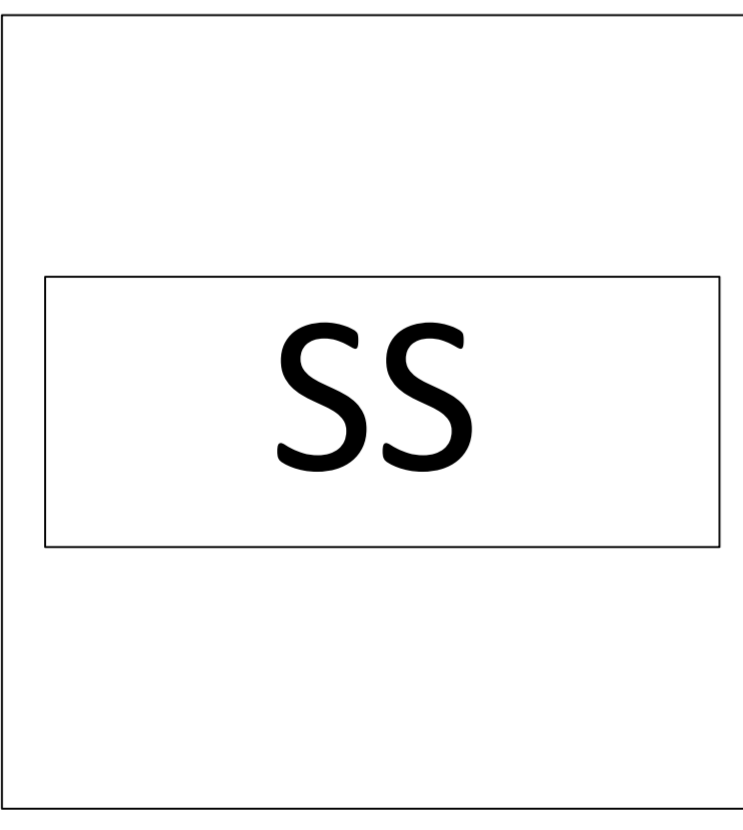
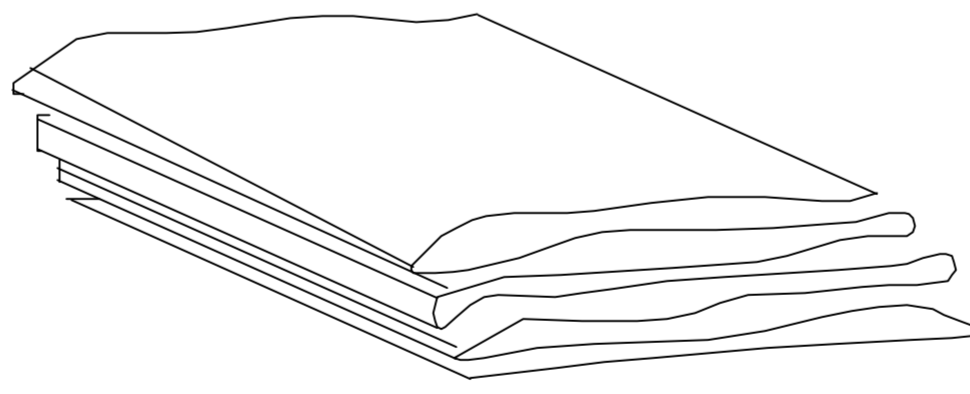
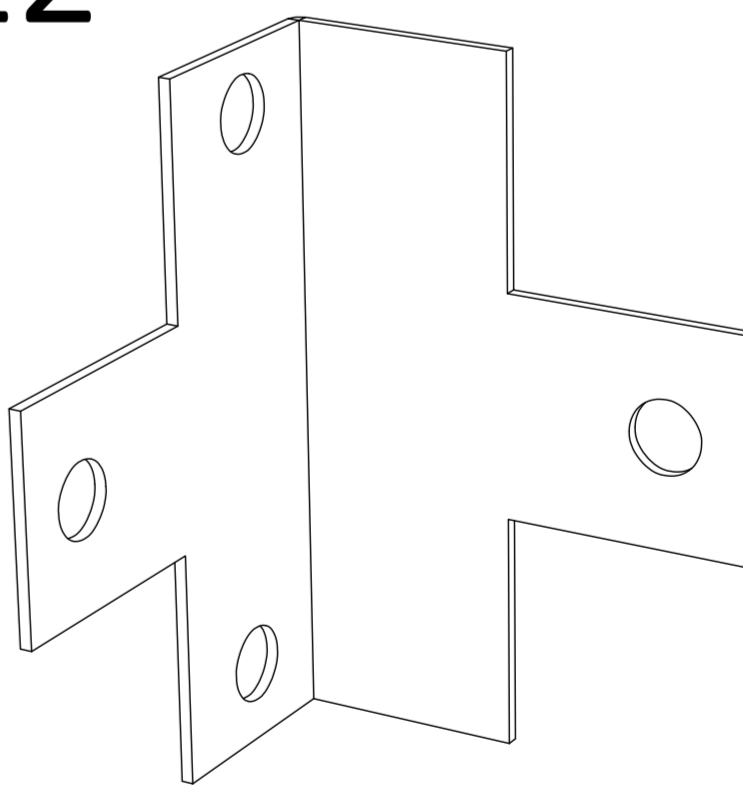
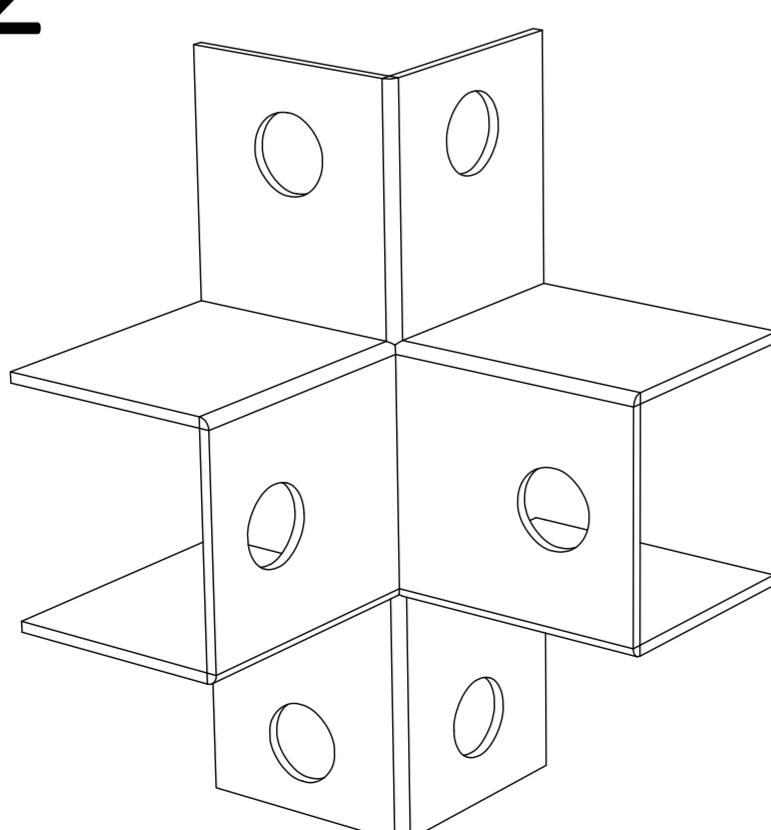
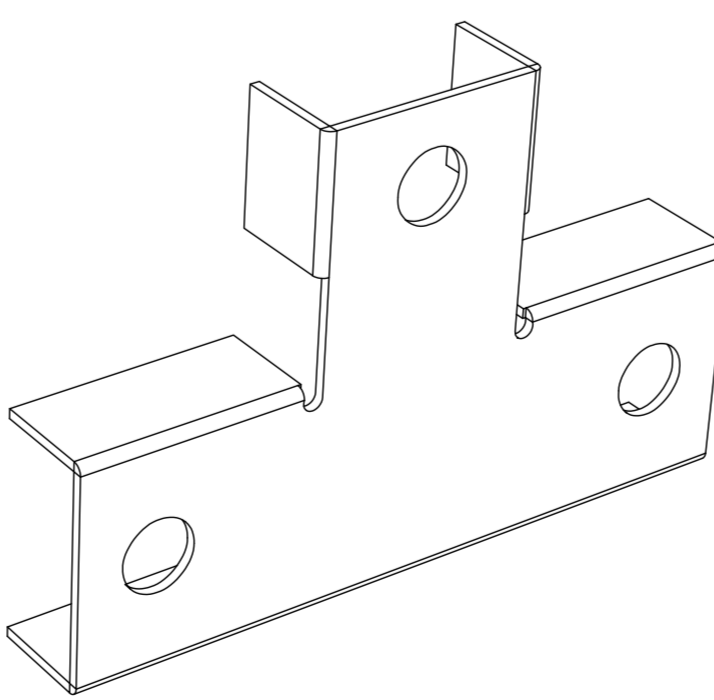
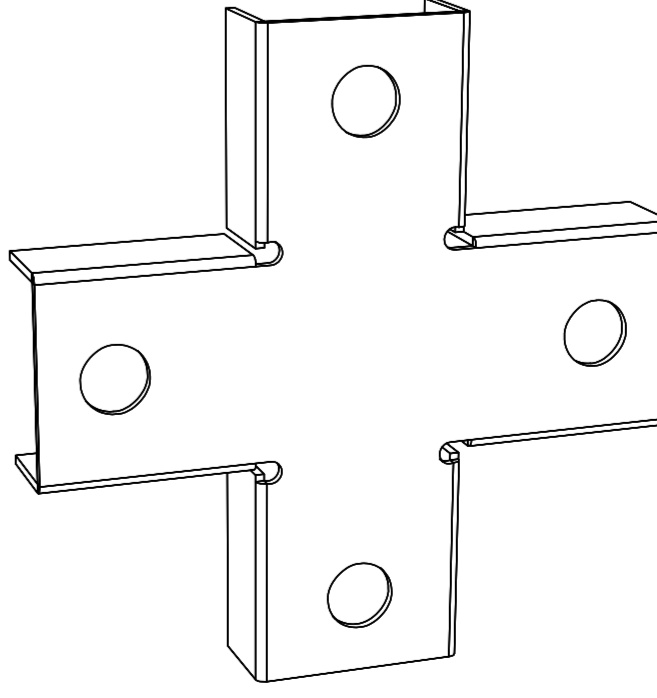
## PARTS LIST BOX OF B

<p>Ⓐ × 22</p> 	<p>Ⓓ1 × 1</p> 	<p>Ⓓ2 × 1</p> 
<p>Vertical Pipe</p>	<p>Main Gate</p>	<p>Small gate</p>
<p>Ⓘ × 16</p> 	<p>Ⓙ × 18</p> 	<p>Ⓛ × 4</p> 
<p>Ground nails</p>	<p>Inclined Tube</p>	<p>Front and rear vertical support rods</p>
<p>ⓈⓈ × 1</p> 	<p>Ⓖ1 × 1</p> 	<p>Ⓚ1 × 12</p> 
<p>Screw pack</p>	<p>Covering cloth</p>	<p>Top outer connector</p>
<p>Ⓚ2 × 12</p> 	<p>Ⓚ3 × 4</p> 	<p>Ⓚ4 × 104</p> 
<p>Top inner connector</p>	<p>Top inner connector</p>	<p>Four-way connectors</p>

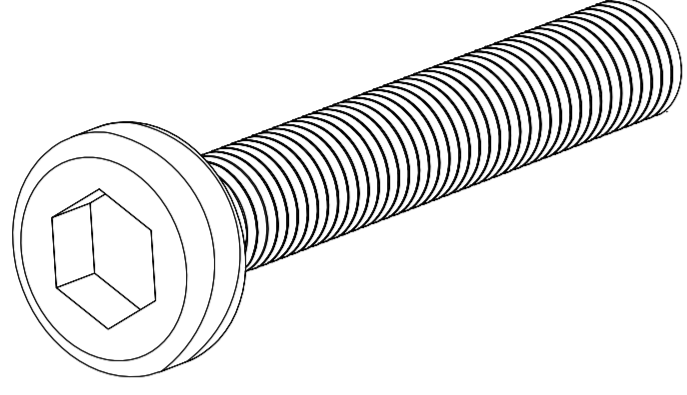
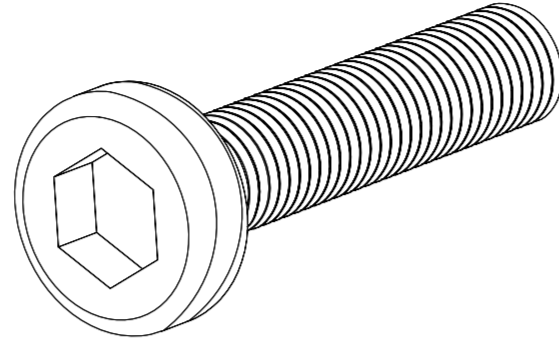
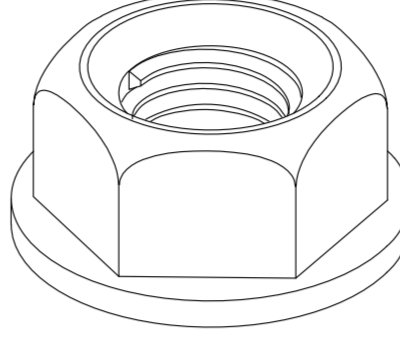
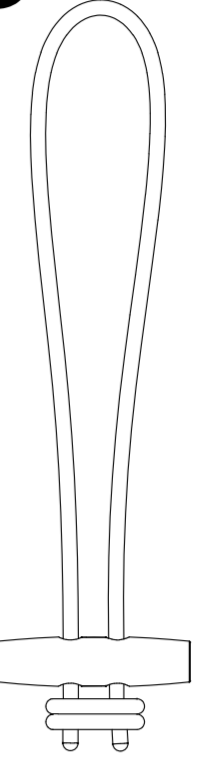
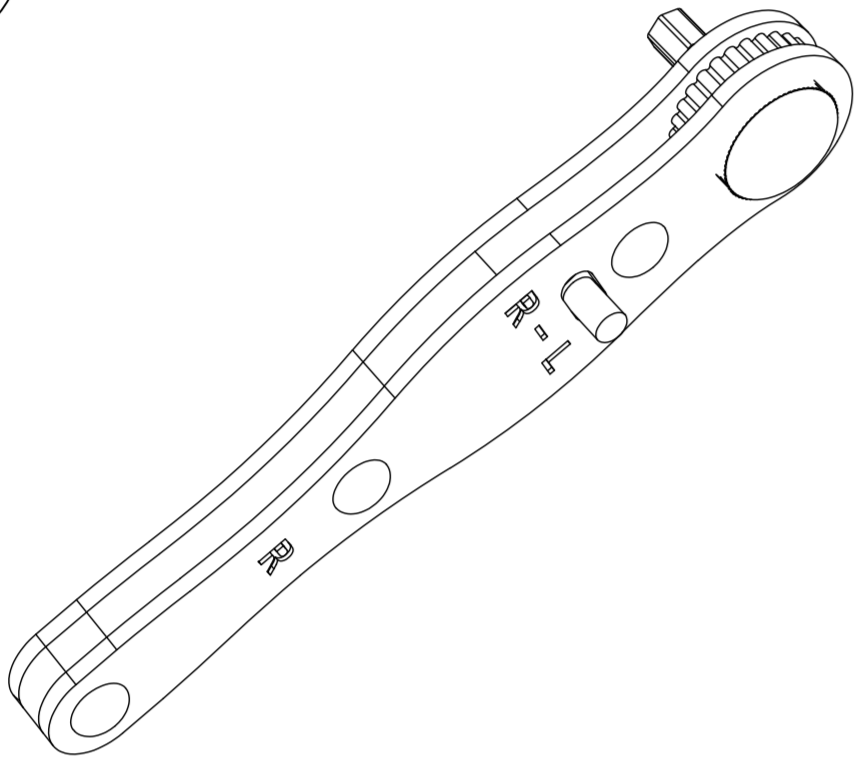
## ARTS LIST BOX OF B

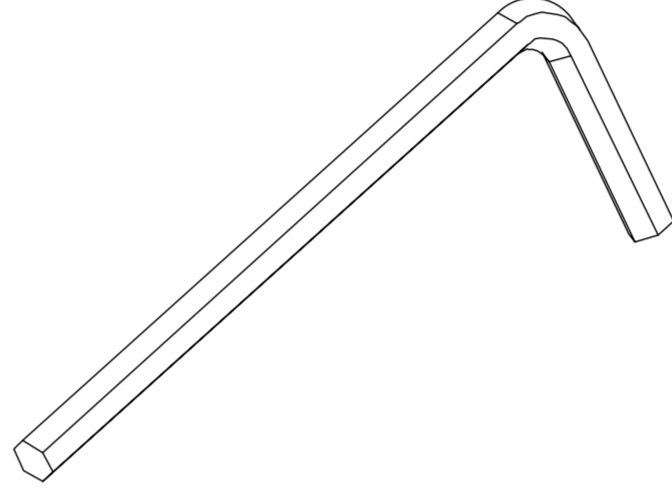
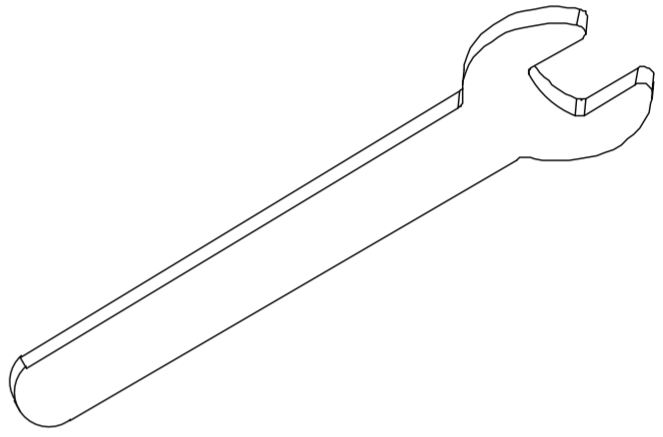
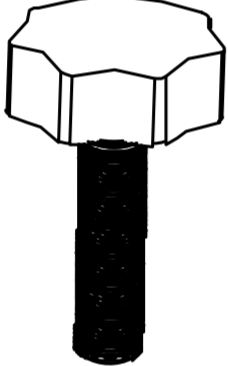
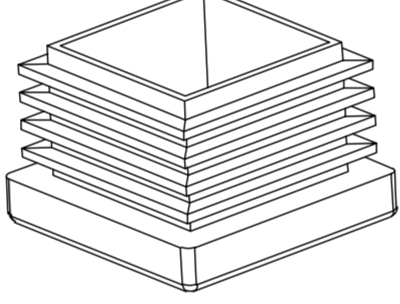
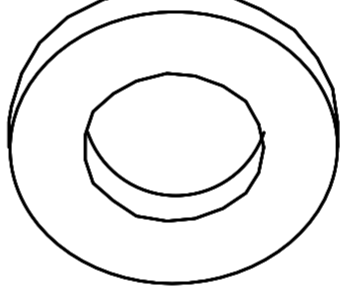
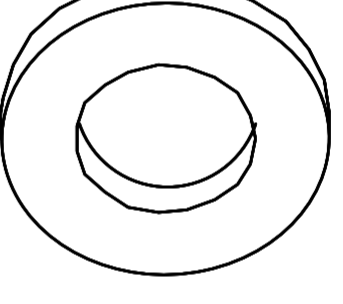
<p>(X) × 4</p>  <p>Bolt M6x45</p>	<p>(Q) × 305</p>  <p>Bolt M6x35</p>	<p>(R) × 292</p>  <p>Washer Nut</p>	<p>(T) × 168</p>  <p>Pull Cord</p>
<p>(O) × 1</p>  <p>Ratche Spanner</p>	<p>(Y) × 1</p>  <p>Gloves</p>	<p>(W) × 1</p>  <p>Spanner</p>	<p>(V) × 2</p>  <p>Wrench</p>
<p>(S) × 2</p>  <p>Bolt M6x40</p>	<p>(P) × 22</p>  <p>Square pipe plug</p>	<p>(Z1) × 2</p>  <p>8MM</p>	<p>(Z2) × 2</p>  <p>3MM</p>

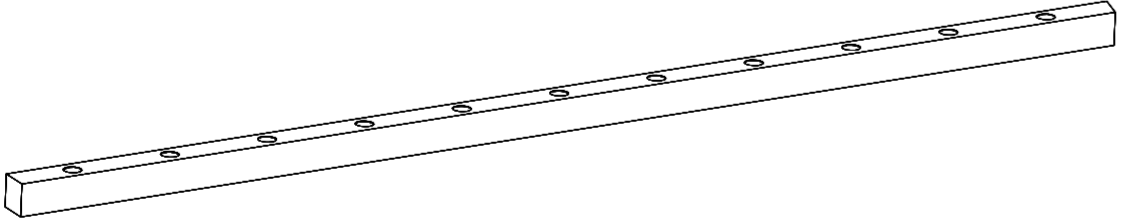
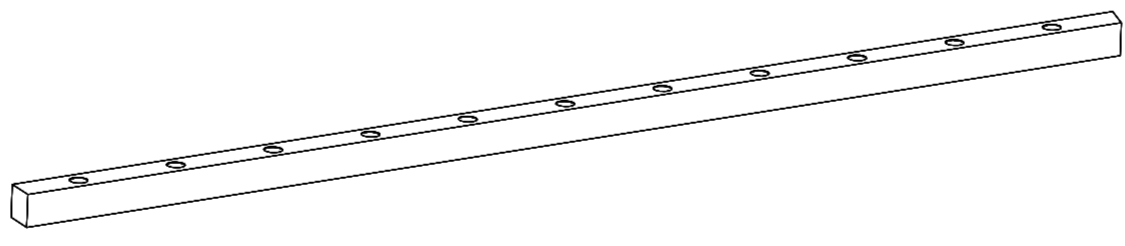
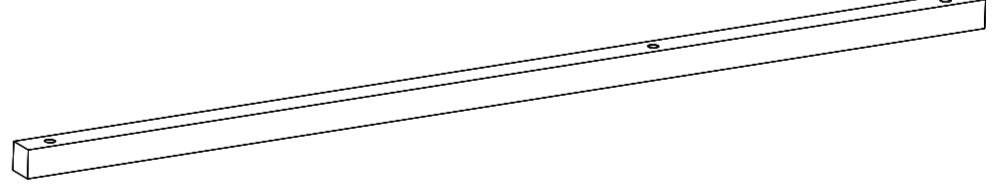
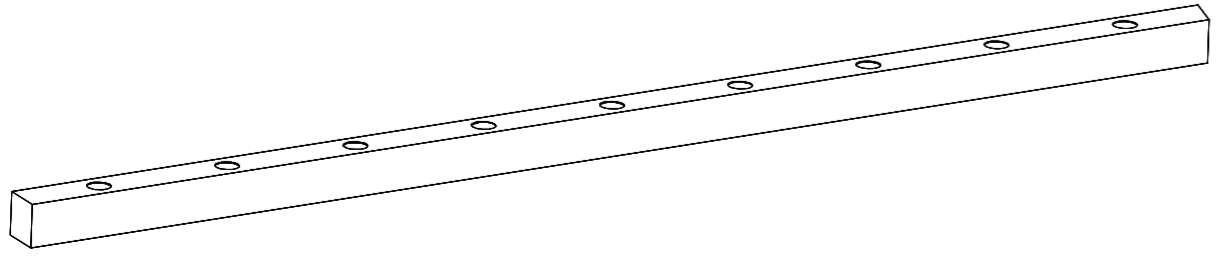
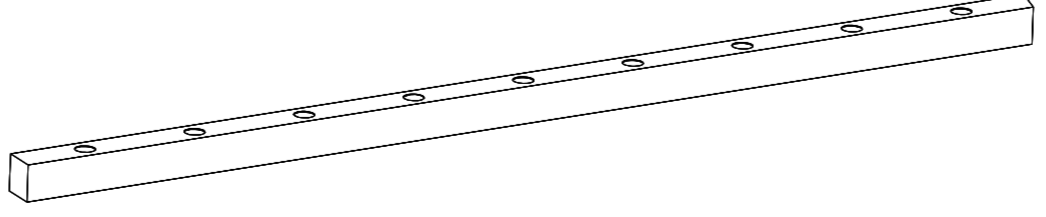
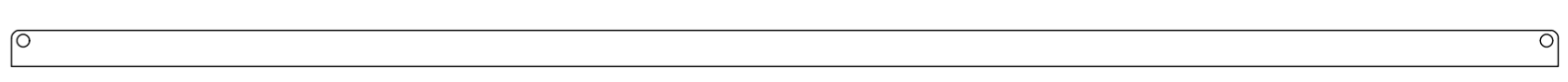

## ARTS LIST BOX OF C

<p>(C1) × 10</p>  <p>Front, Rear, Upper and Lower Horizontal Pipes</p>	<p>(C2) × 5</p>  <p>Front, Rear and Middle Horizontal Pipes</p>	<p>(D) × 2</p>  <p>Upper and Lower Horizontal Pipes of the Door</p>
<p>(B1) × 32</p>  <p>Left, Right, Upper and Lower Horizontal Pipes</p>	<p>(B2) × 16</p>  <p>Left, Right and Middle Horizontal Pipes</p>	<p>(U) × 7</p>  <p>U-groove</p>

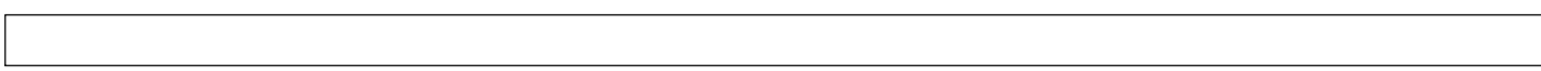
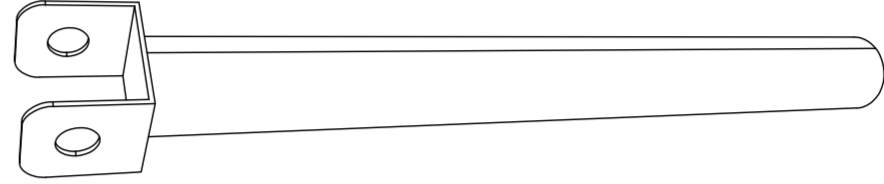
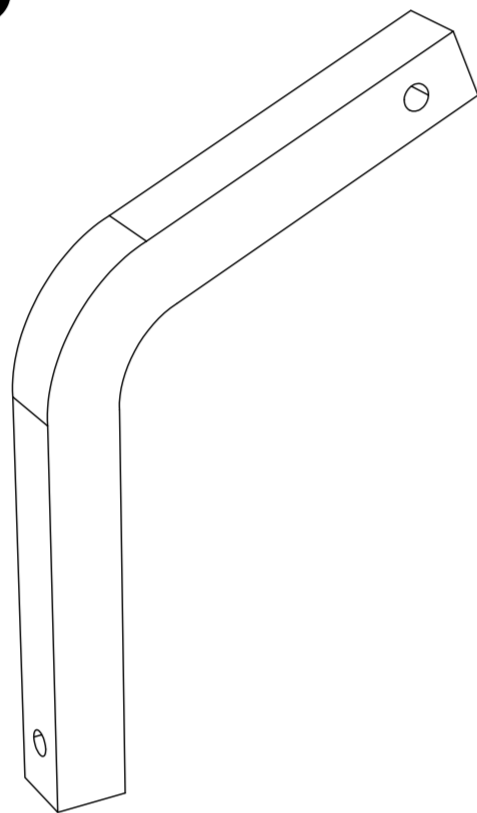
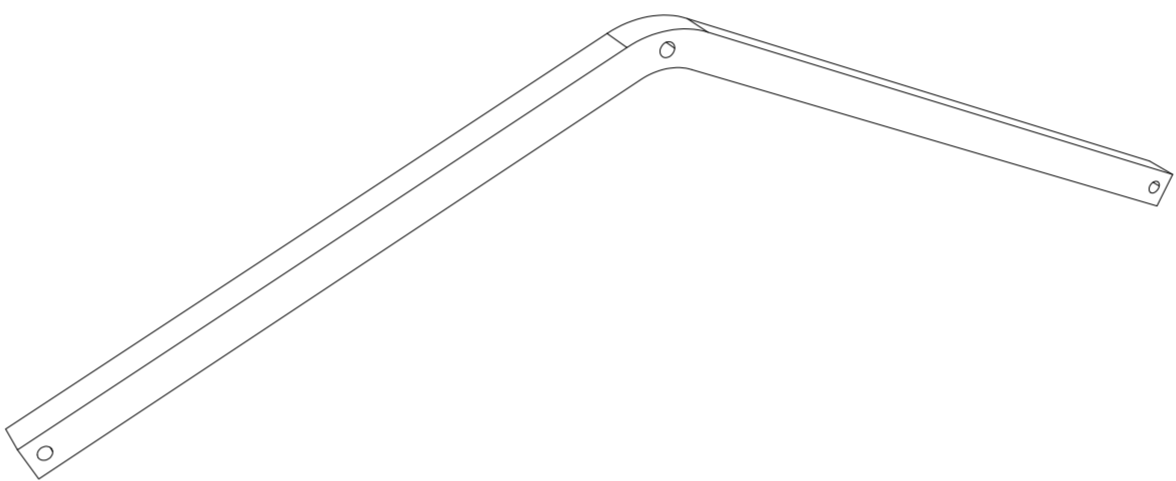
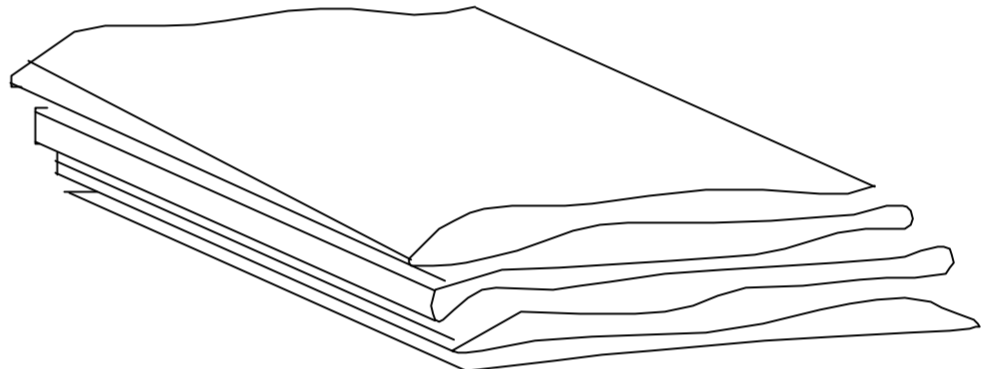
# ARTS LIST BOX OF C

<p><math>F1 \times 21</math></p> 	<p><math>F2 \times 3</math></p> 	<p><math>H \times 7</math></p> 
<p>Horizontal Support Bar1</p>	<p>Horizontal Support Bar2</p>	<p>Top Vertical Support Tubes</p>
<p><math>M \times 18</math></p> 	<p><math>N \times 9</math></p> 	<p><math>G3 \times 4</math></p> 
<p>Elbow tube</p>	<p>Top support rod</p>	<p>The side cover cloth of the dog crate</p>

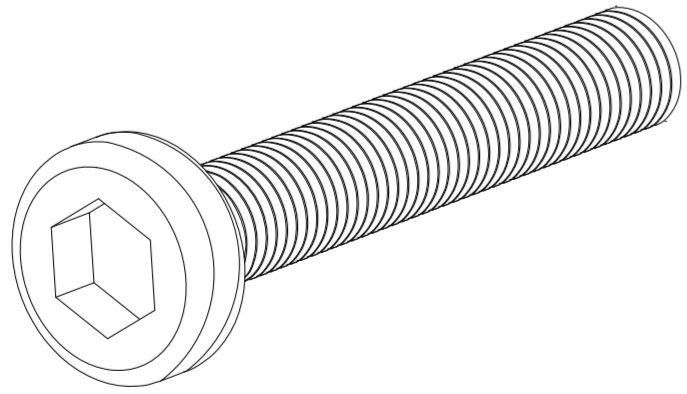
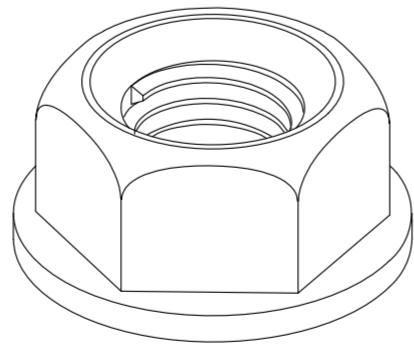
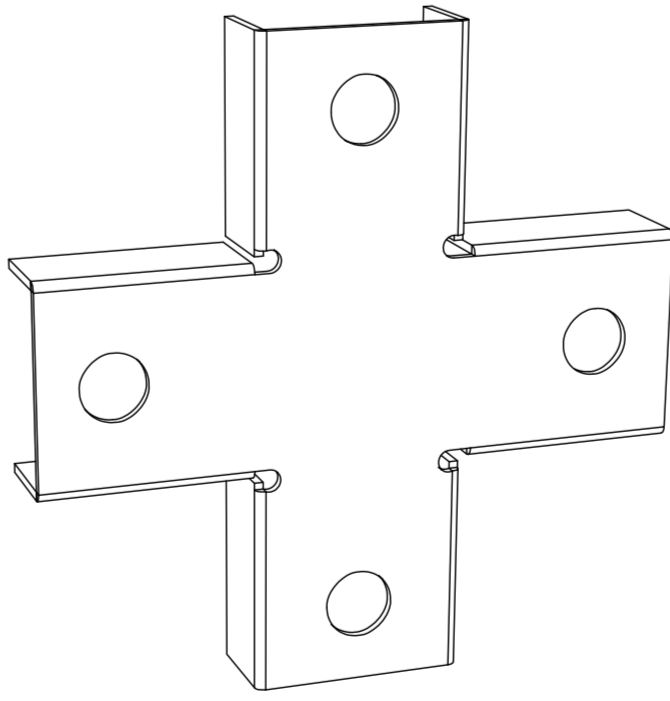
## spare parts

<p><math>Q \times 10</math></p>  <p>Bolt M6x35</p>	<p><math>R \times 10</math></p>  <p>Washer Nut</p>	<p><math>K4 \times 2</math></p>  <p>Four-way connectors</p>	<p><math>T \times 2</math></p>  <p>Pull Cord</p>
---	---	--	---

**WARNING:** Failure to locate parts in accordance with these diagrams, or failure to use special parts provided with this equipment, may result in property damage or personal injury.

# Step 1

This is the installation drawing of the lowermost pipe.

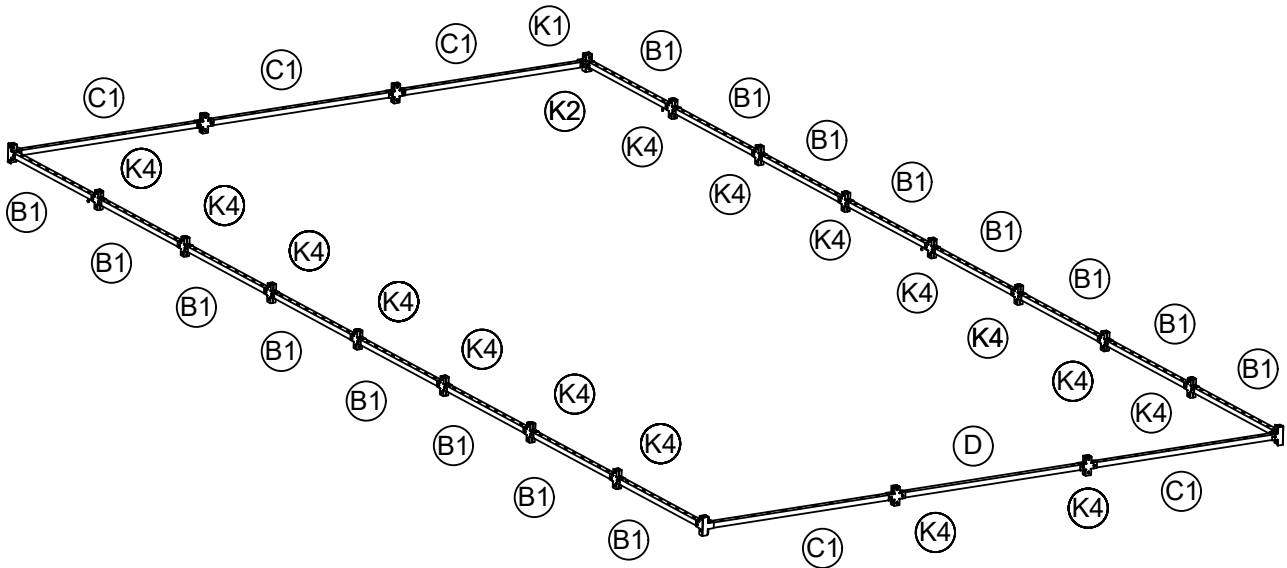

# Step 2

Connect part **B1** to part **K4**, and fasten them with screws **Q** and nuts **R**.  
 Connect part **C1** to part **K4**, and fasten them with screws **Q** and nuts **R**.  
 Connect parts **C1**, **D**, and **K4** together, and fasten them with screws **Q** and nuts **R**.  
 For the four corner positions, use parts **K1** and **K2** to connect them, and secure with screws **Q** and nuts **R**.

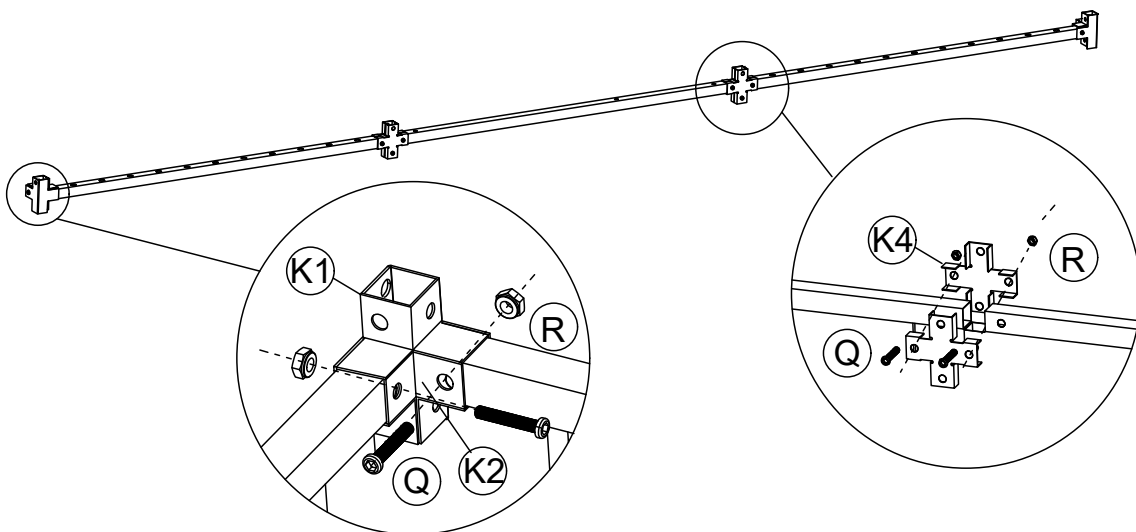

<b>B1</b> × 16	<b>C1</b> × 5	<b>D</b> × 1

<b>K1</b> × 4	<b>K2</b> × 4	<b>K4</b> × 36	<b>Q</b> × 44	<b>R</b> × 44

## Step 3

Drive the rubber plug (**Part P**) into the nozzle/opening of (**Part A**), as shown in the diagram.

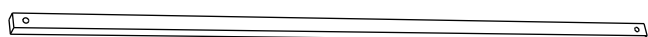
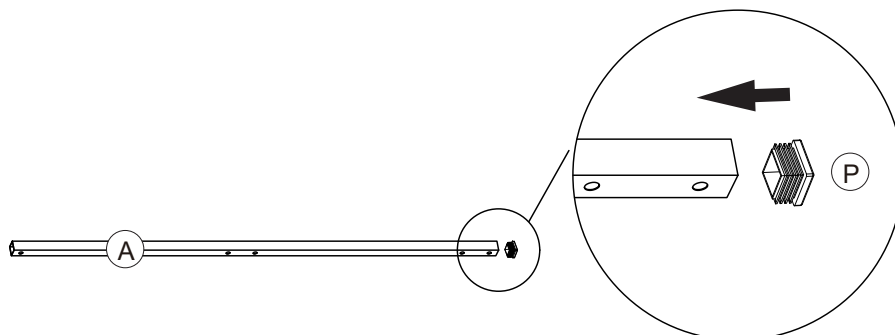

(A) × 22



(P) × 22

## Step 4

Insert Part A into each connection joint.

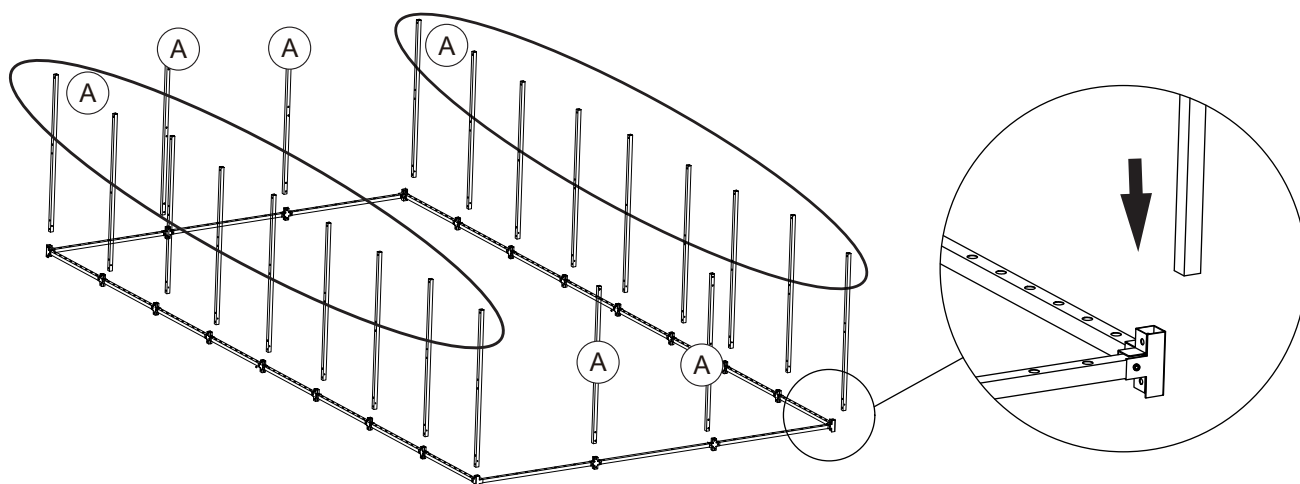

## Step 5

Fasten Part **A** securely with screws **Q** and nuts **R**.

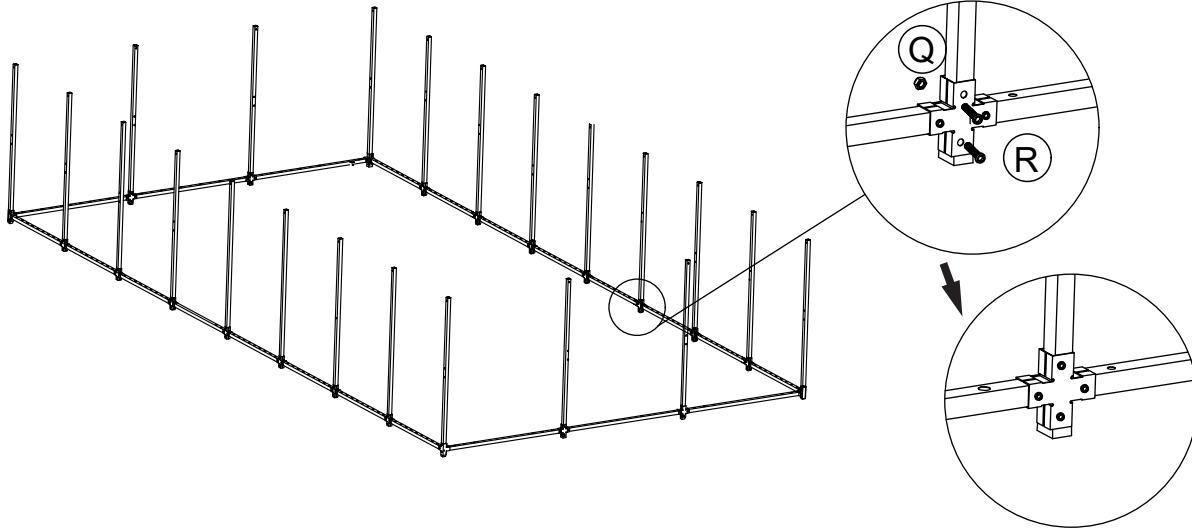

## Step 6

Arrange Part **B2** and Connector **K4** as shown in the diagram, then fasten and secure them with Screws **Q** and Nuts **R**.  
 Arrange Part **C2** and Connector **K3** as shown in the diagram, then fasten and secure them with Screws **Q** and Nuts **R**.  
 Install all the surrounding components in the sequence indicated in the diagram.

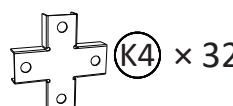
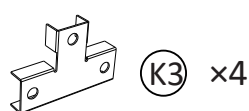
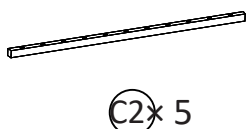
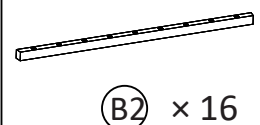
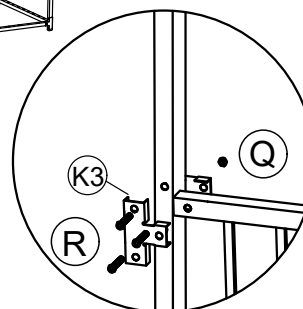
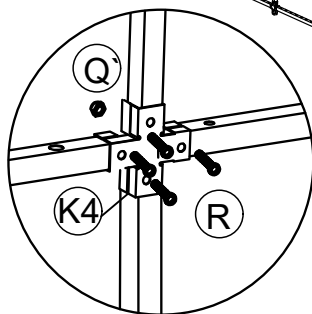
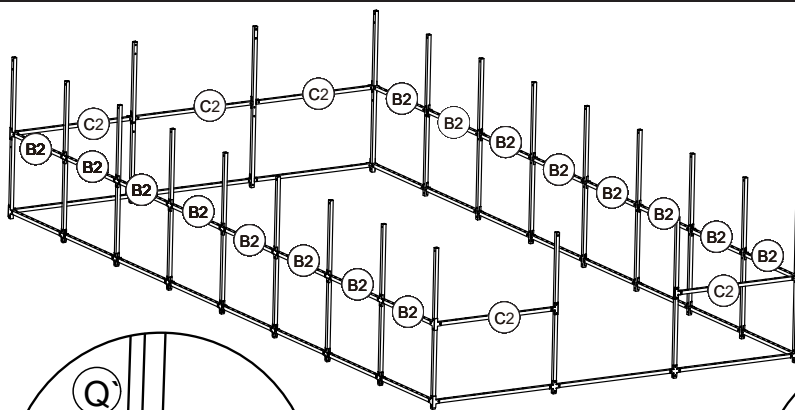

## Step 7

Connect the four corners using connectors **K1** and **K2**, then fasten and lock them with screws **Q** and nuts **R**.

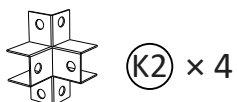
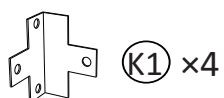
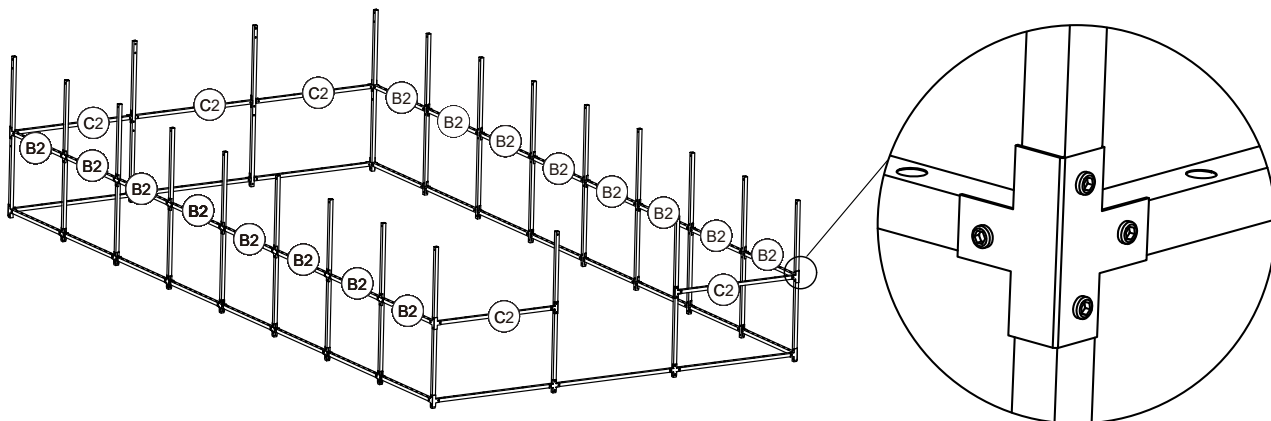

## Step 8

Insert Part **E** into the hole of each component, as shown in the diagram.

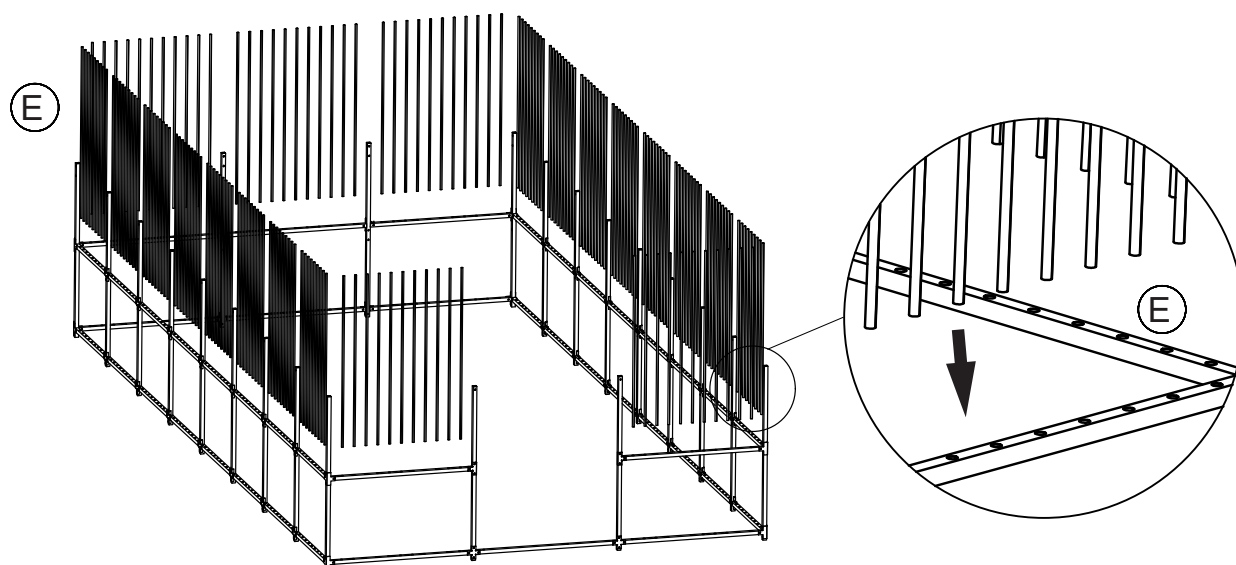

(E) x 199

## Step 9

Arrange Part **B1** and Connector **K4** as shown in the diagram, then fasten and secure them with Screws **Q** and Nuts **R**.  
 Arrange Part **C1** and Connector **K4** as shown in the diagram, then fasten and secure them with Screws **Q** and Nuts **R**.  
 Install all the surrounding components in the sequence indicated in the diagram.  
 Use Connectors **K1** and **K2** to join the four corners, and fasten and lock them with Screws **Q** and Nuts **R**.

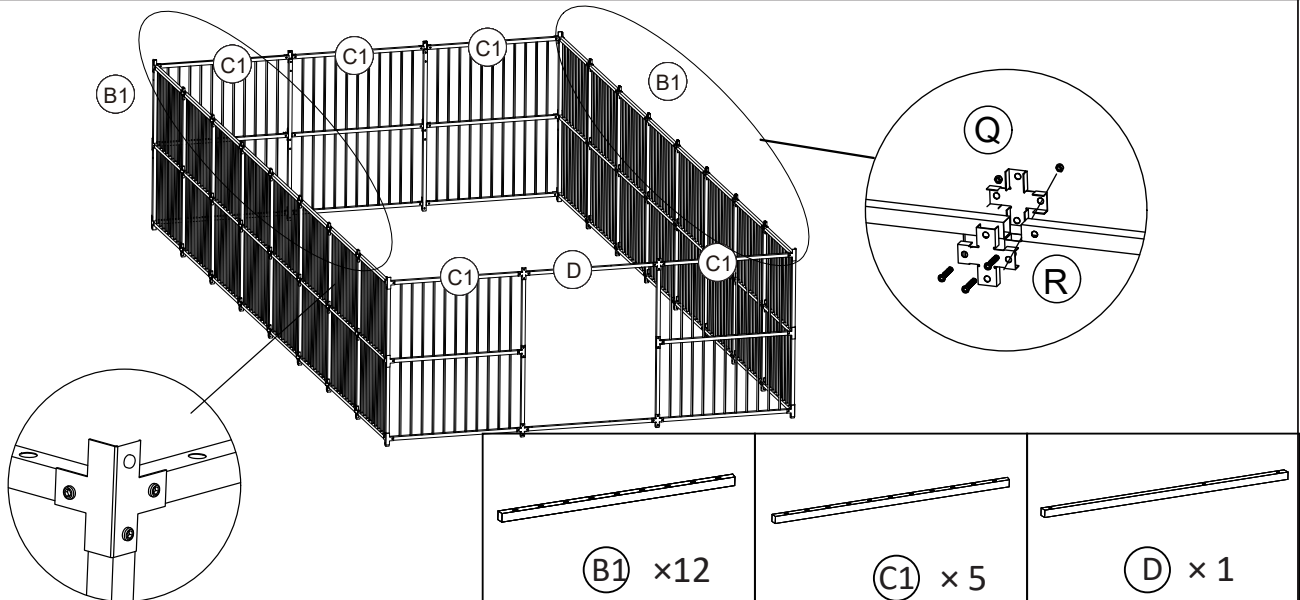

**B1** × 12

**C1** × 5

**D** × 1

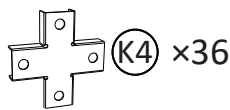
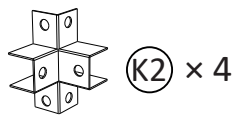
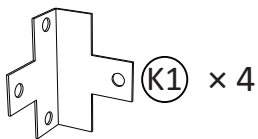

## Step 10

Insert Part **H** into the nozzle/opening of each connector as shown in the diagram, then fasten and secure it with screws **Q** and nuts **R**.

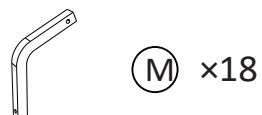
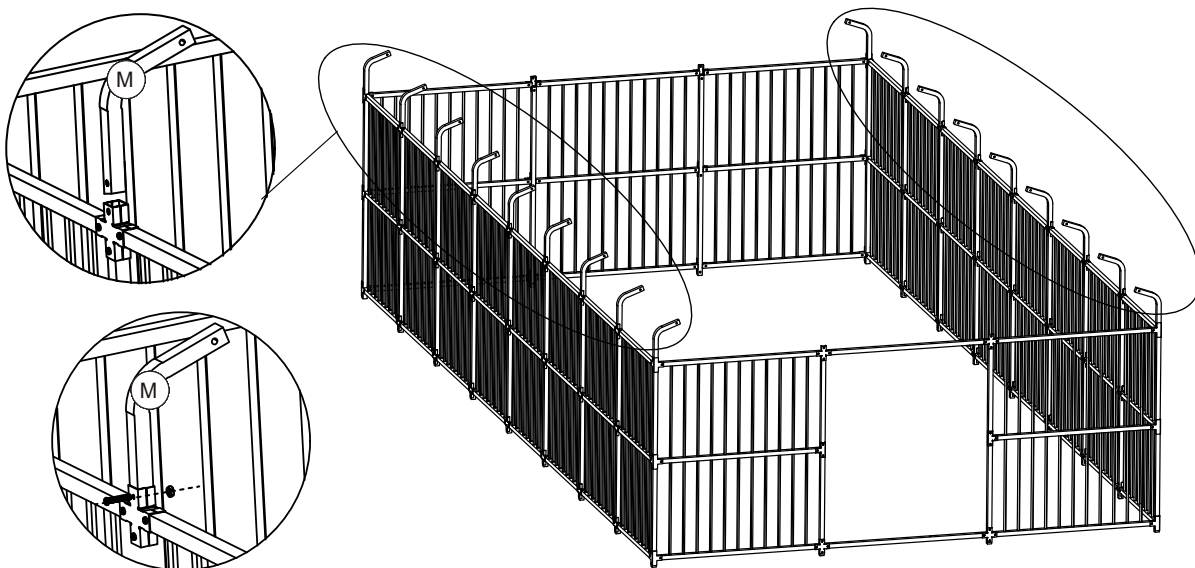

## Step 11

Insert Part **N** into Part **J** as shown in the diagram, then fasten and secure them with screws **Q** and nuts **R**.

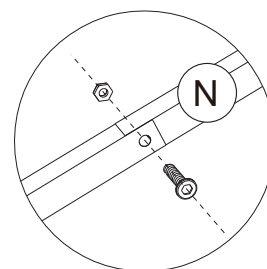
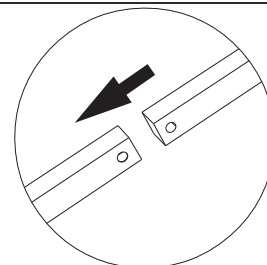
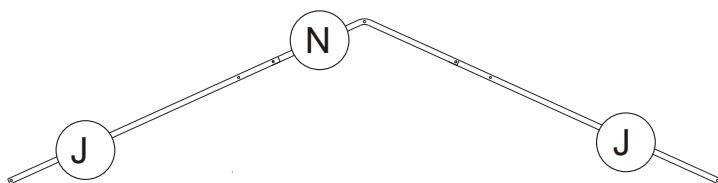

**J** × 18

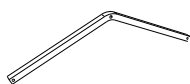

**N** × 9

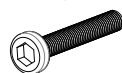

**Q** × 18



**R** × 18

## Step 12

Insert the component installed in **Step 11** into **M** as shown in the diagram.

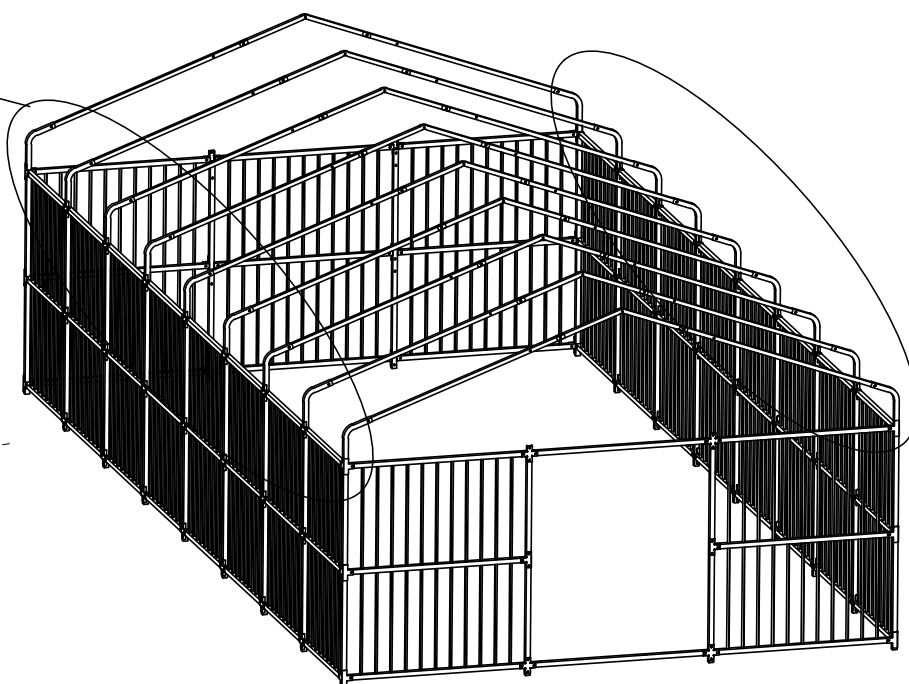
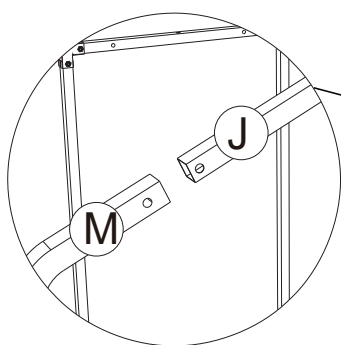

## Step 13

Install Parts **F1** and **F2** in sequence as shown in the diagram, and fasten both ends with Screws **Q**.

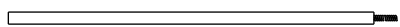
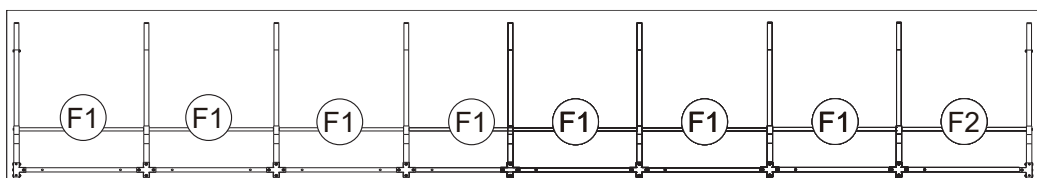
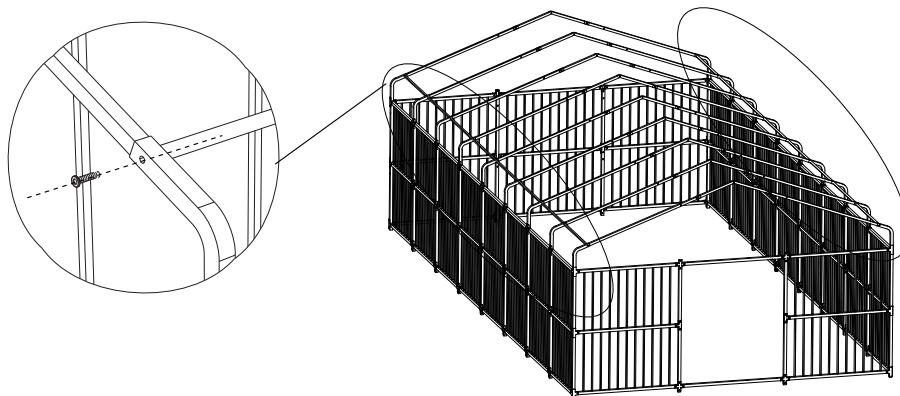

**F1** × 14

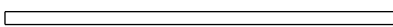

**F2** × 2



**Q** × 4

## Step 14

Install Parts **F1** and **F2** in the specified sequence as shown in the diagram, and fasten both ends with Screws **Q**.

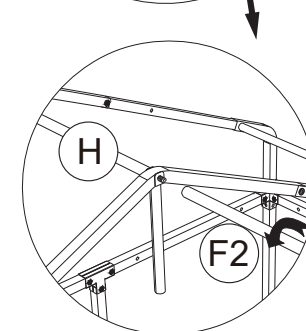
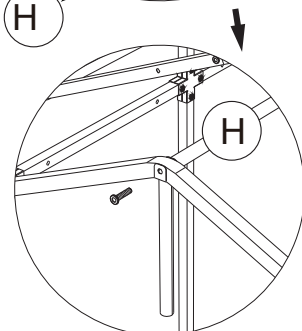
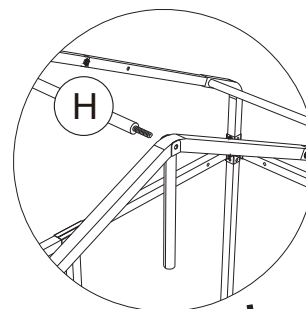
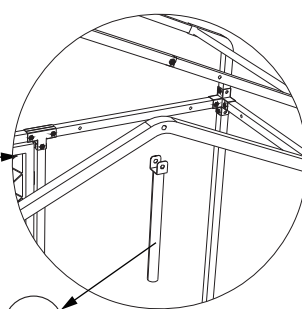
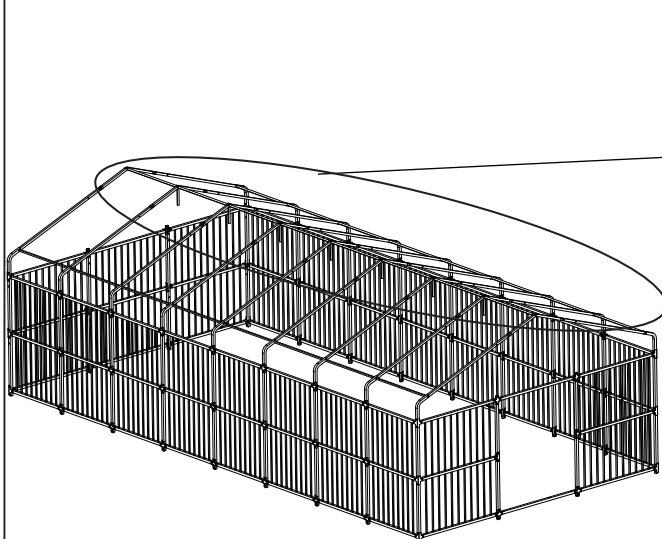

**H** × 7



**F1** × 7



**F2** × 1



**Q** × 2

## Step 15

Position Part **U** according to the diagram, fix it in place with Screws **Q** and Nuts **R**, and then secure Part **H** tightly at the middle of Part **U** using a Screw **Q**.

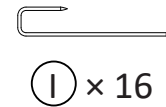
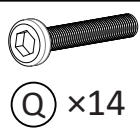
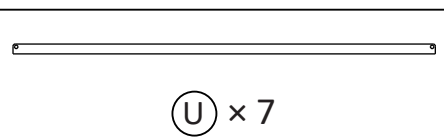
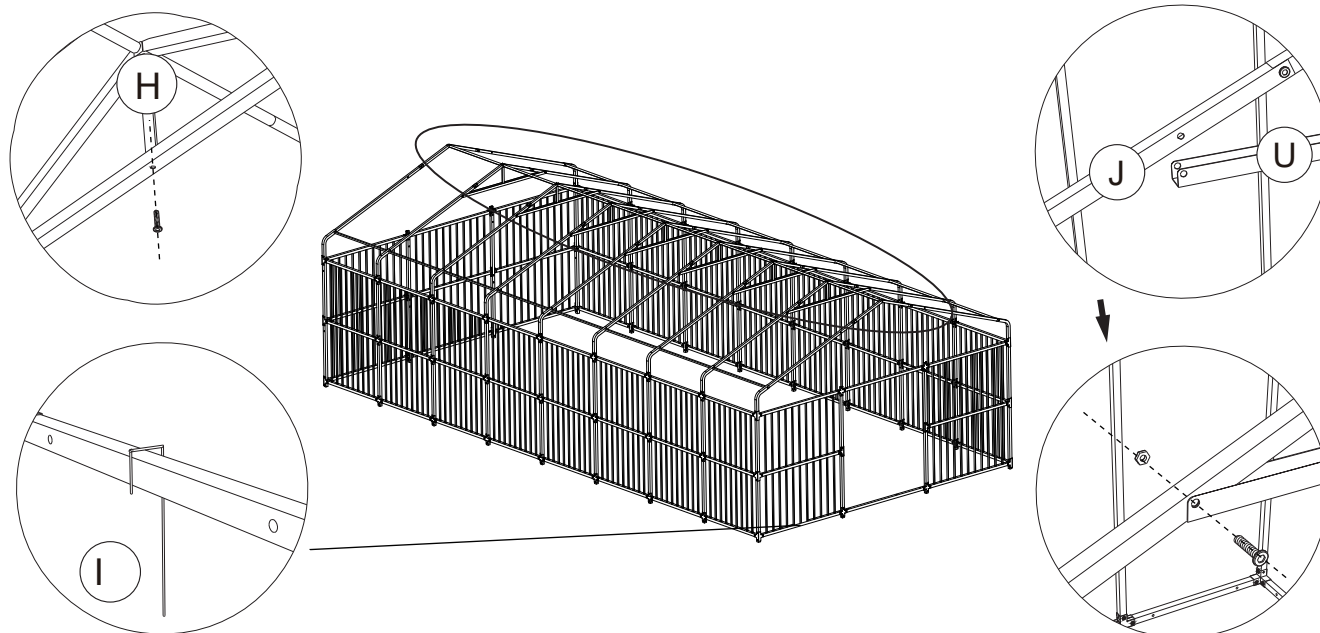

## Step 16

Arrange Part **L** as shown in the diagram and fasten it tightly with Screws **Q** and Nuts **R**.

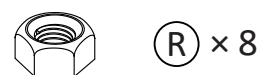
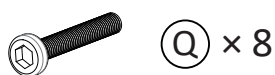
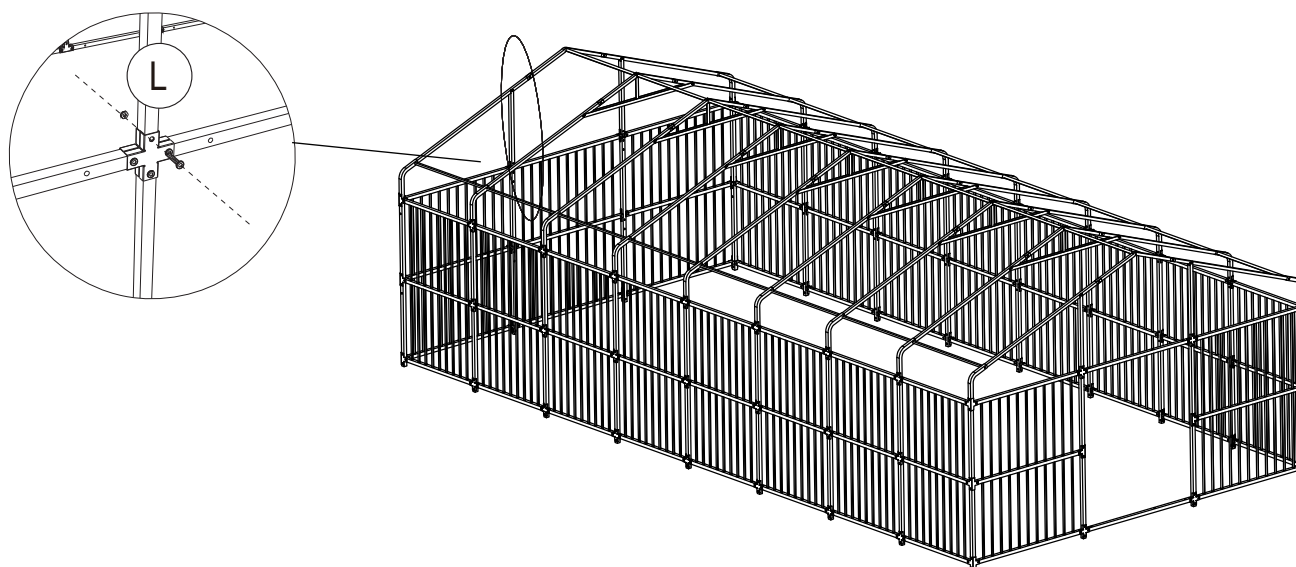

## Step 17

Arrange Part **D1** as shown in the diagram and fasten it with Screws **C** and Washers **Z1**.  
 Arrange Part **D2** as shown in the diagram and fasten it with Screws **C** and Washers **Z2**.  
 Use Torx Screws **S** to secure [the assembly/ relevant components] when not in use

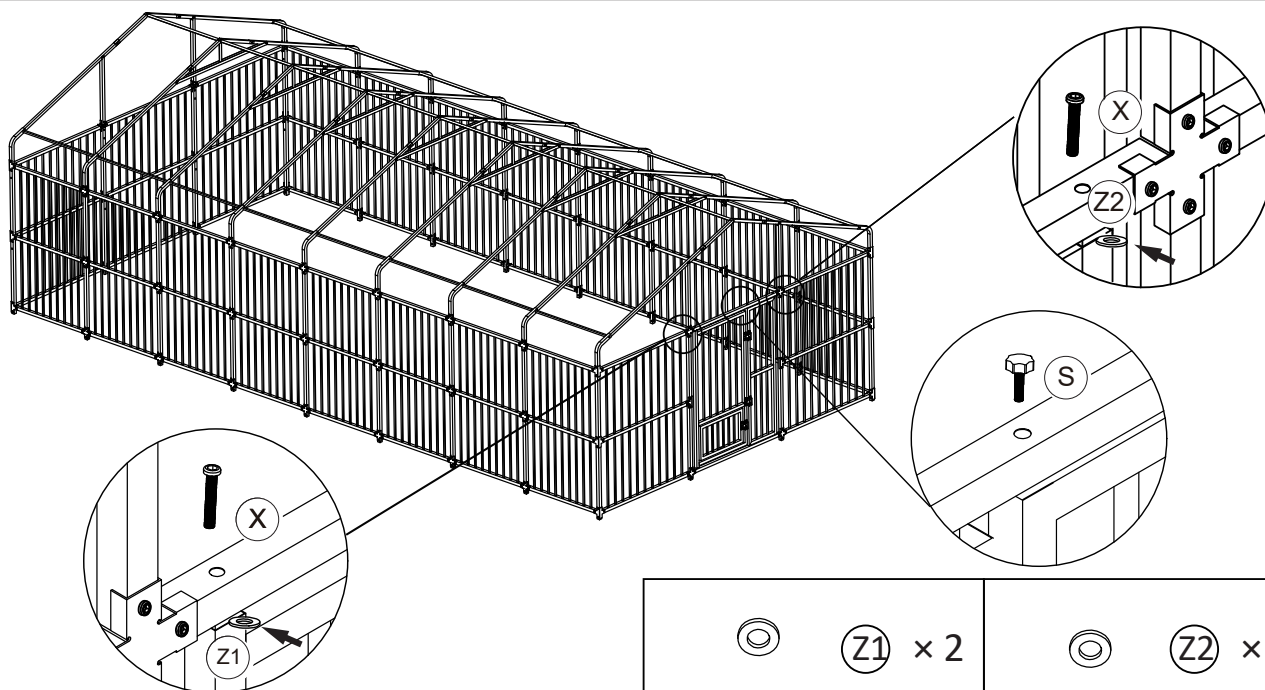

**D1** × 1



**D2** × 1



**C** × 4



**S** × 2



**Z1** × 2



**Z2** × 2

## Step 18

Fix Covers **G2**, **G3** and Component **T** as Per the Diagram

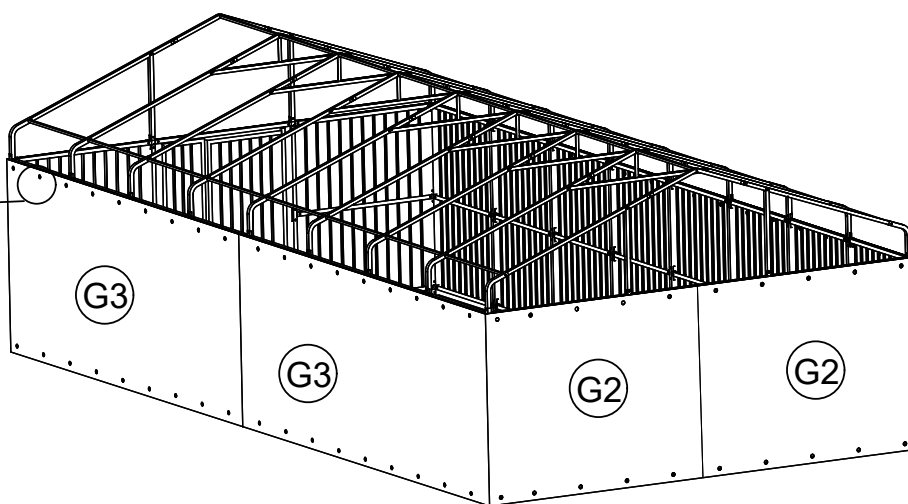
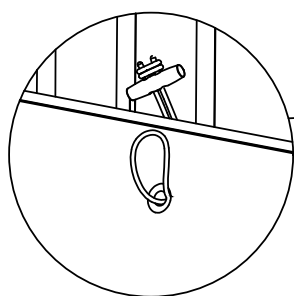

**G3** × 4



**T** × 112



**G2** × 4

**Step 19**

Zip up the zippers between the enclosure fabrics according to the diagram.

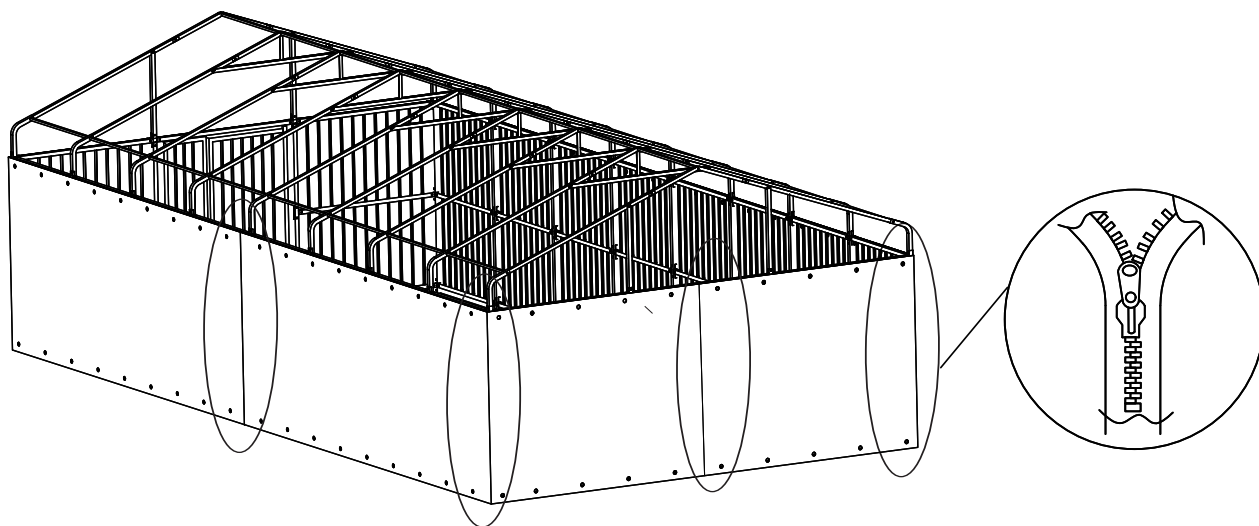

**Step 20**

Cover the tarpaulin (G1) over the top of the dog cage.

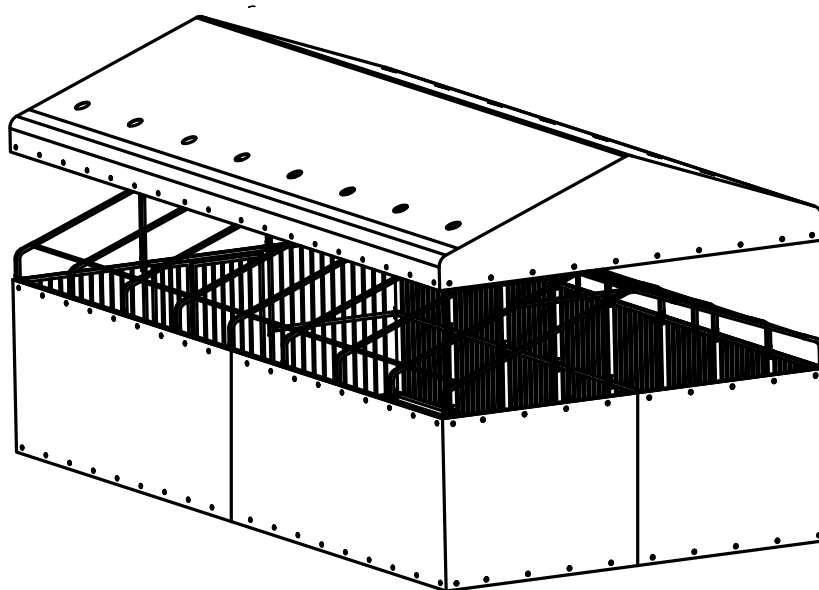

(G1) × 1

**Step 21**

Secure the back top **G1** to Part **T** as shown in the diagram

