

ASSEMBLY INSTRUCTIONS

TWIN HOUSE BUNK BED

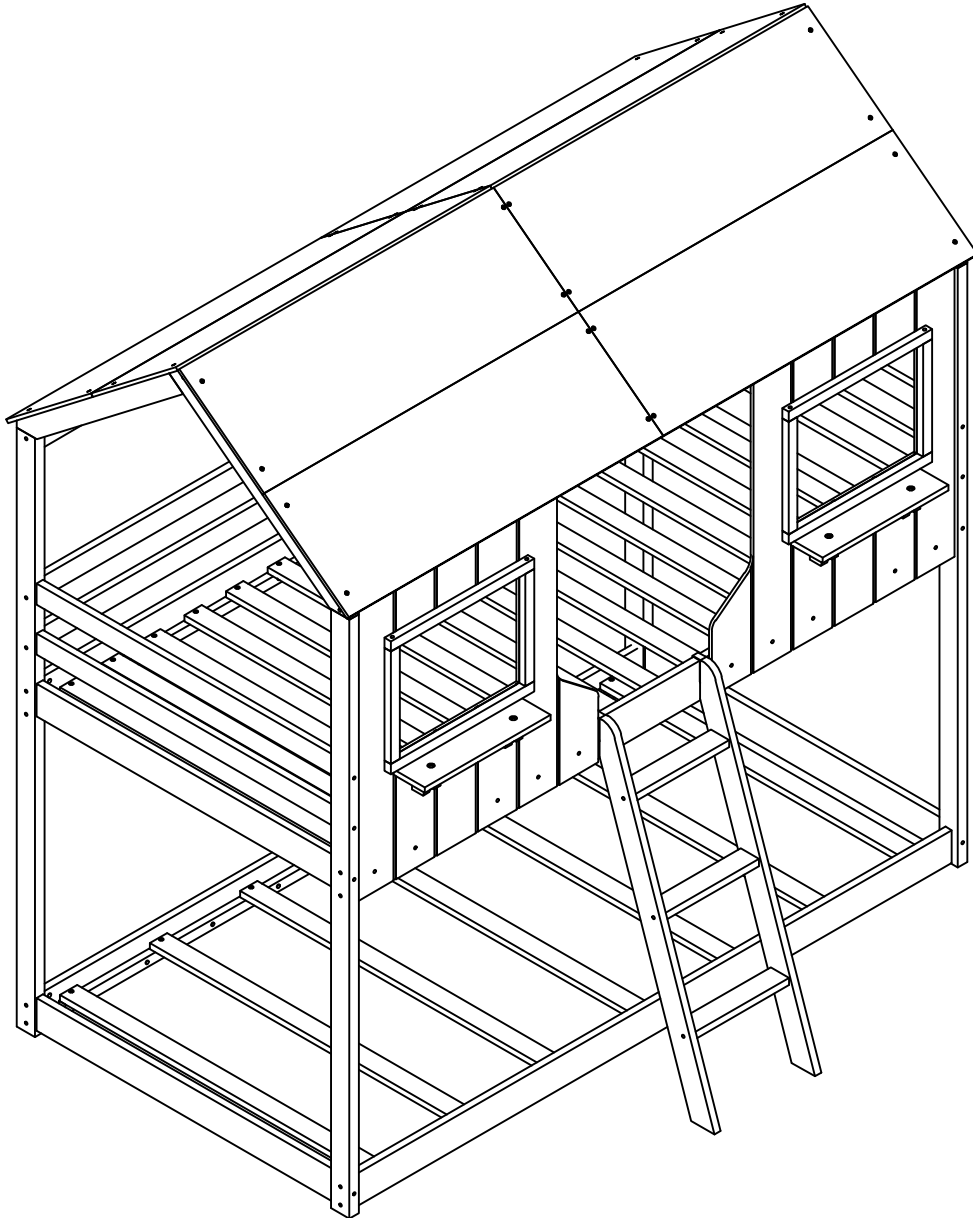

ASSEMBLY INSTRUCTIONS



SAFETY WARNINGS



1. This bed is designed for use only mattress (es) meeting the following specifications on the upper bunk, and lower bunk:

Upper bunk (bunk bed and tribed included)

| Bed Type | Length | Width | Thickness |
|-----------------|---------------|---|------------------|
| Twin Standard | 74" - 75" | 37 $\frac{1}{2}$ " - 38 $\frac{1}{2}$ " | 6" max |

Lower bunk

| Bed Type | Length | Width | Thickness |
|-----------------|---------------|---|------------------|
| Twin Standard | 74" - 75" | 37 $\frac{1}{2}$ " - 38 $\frac{1}{2}$ " | 8" max |

2. Replacement parts, including additional guardrails, maybe obtained from any of our (GIGACLOUD TECHNOLOGY (USA) INC. 18961 ARENTH AVENUE CITY OF INDUSTRY, CA, 91748) dealers
3. Follow the information on the warnings appearing on the upper bunk bed end structure and on the carton. Do not remove warning label from bed.
4. Always use the recommended size mattresses or mattress supports, or both, to help prevent the likelihood of entrapment or falls.
5. Surface of mattress must be at least 5" (127mm) below the upper edge of guardrails.
6. Do not allow children under 6 years of age to use the upper bunk.
7. Periodically check and ensure that the guardrail, ladder, and other components are in their proper position, free from damage, and that all connectors are tight.
8. Do not allow horseplay on or under the bed and prohibit jumping on the bed.
9. Always use the ladder for entering and leaving the upper bunk.
10. Do not use substitute part. Contact the manufacture or dealer for replacement part.
11. Use of a night light may provide added safety precaution for a child using the upper bunk.
12. Always use guardrails on both long sides of the upper bunk. If the bunk bed will be placed next to the wall, the guardrail that runs the full length of the bed should be placed against the wall to prevent entrapment between the bed and wall.
13. The use of water or sleep flotation mattresses is prohibited.
14. **STRANGULATION HAZARD** - Never attach or hang items to any part of the bunk bed that are not designed for use with the bed; for example, but not limited to, hook, belts and jump ropes.
15. Keep these instruction for future reference.
16. Prohibit more than one person on upper bunk
17. We recommend assembling your bunk bed on the shipping carton to protect your floor or carpet.
18. Be certain all staples are out of the box before beginning assembly on the shipping carton.

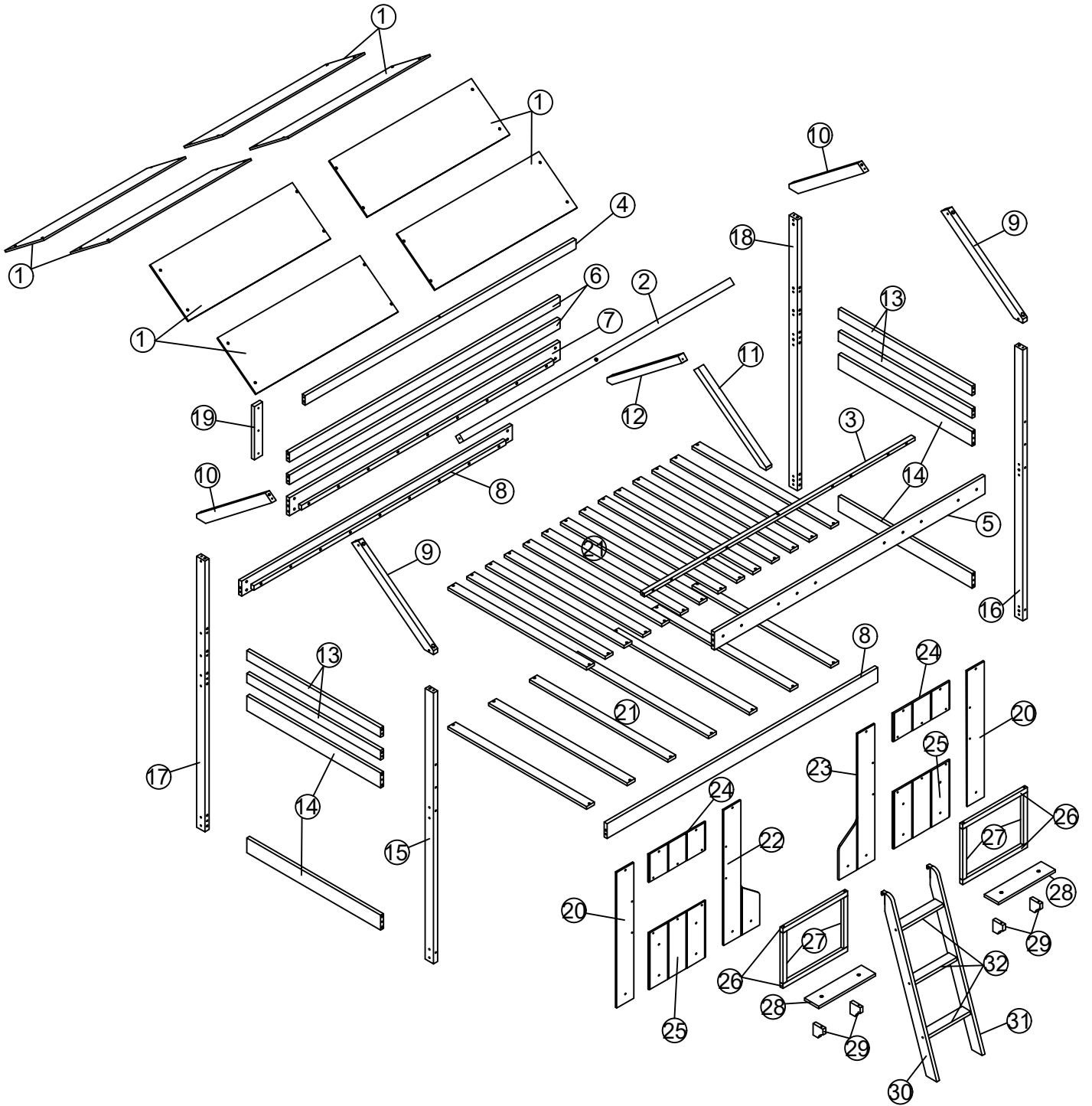

ASSEMBLY INSTRUCTIONS

DETAIL VIEW





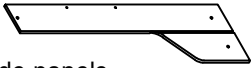
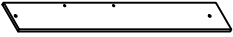

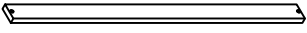
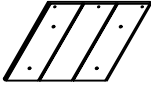
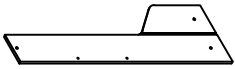

ASSEMBLY INSTRUCTIONS

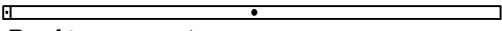
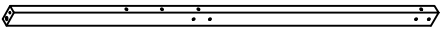
PARTS LIST

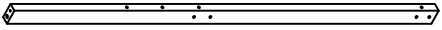
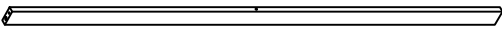
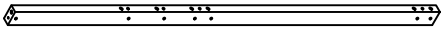
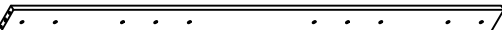
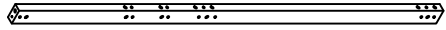
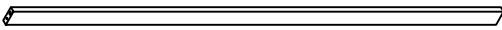
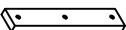
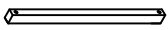

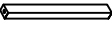
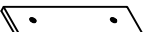

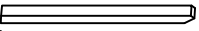
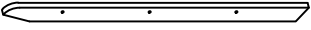
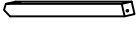
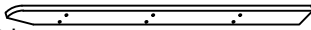
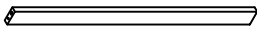
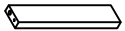
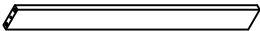







| | | | | | |
|-----------|--|-------|-----------|--|------|
| 1 | Roof panels  | 8pcs | 23 | Right window - side panels  | 1pc |
| 20 | Window side panels  | 2pcs | 24 | Window upper panels  | 2pcs |
| 21 | Slats (upper 14pcs / lower 7pcs)  | 21pcs | 25 | Window lower panels  | 2pcs |
| 22 | Left window - side panels  | 1pc | | | |

Hardware

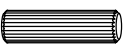
| | | | | | |
|-----------|---|------|-----------|---|------|
| 2 | Roof top support  | 1pc | 15 | Left front leg  | 1pc |
| 3 | Roof front support  | 1pc | 16 | Right front leg  | 1pc |
| 4 | Roof back support  | 1pc | 17 | Left back leg  | 1pc |
| 5 | Front side rail  | 1pc | 18 | Right back leg  | 1pc |
| 6 | Back guard rails  | 2pcs | 19 | Guard rail support  | 1pc |
| 7 | Back side rail  | 1pc | 26 | Window frame  | 4pcs |
| 8 | Bottom side rails  | 2pcs | 27 | Window frame  | 4pcs |
| 9 | Roof - front support  | 2pcs | 28 | Window bar  | 2pcs |
| 10 | Roof - back support  | 2pcs | 29 | Window bar supports  | 4pcs |
| 11 | Roof - center front support  | 1pc | 30 | Ladder - left leg  | 1pc |
| 12 | Roof - center back support  | 1pc | 31 | Ladder - right leg  | 1pc |
| 13 | Head board panels  | 4pcs | 32 | Ladder steps  | 3pcs |
| 14 | Head board panels  | 4pcs | | | |

ASSEMBLY INSTRUCTIONS



HARDWARE LIST

| | | | | | | | |
|----------|---------|---|-------|----------|---------|---|-------|
| A | Ø4x30 |  | 45PCS | H | 6.5x30 |  | 8PCS |
| B | Ø4x25 |  | 52PCS | I | 1/4x75 |  | 16PCS |
| C | Ø4x15 |  | 6PCS | J | 1/4x20 |  | 10PCS |
| D | 6.5x100 |  | 16PCS | K | Ø10x40 |  | 50PCS |
| E | 6.5x80 |  | 15PCS | L | 4x70 |  | 1PC |
| F | 6.5x60 |  | 18PCS | M | 70x18x2 |  | 2PCS |
| G | 6.5x40 |  | 9PCS | | | | |

ASSEMBLY INSTRUCTIONS

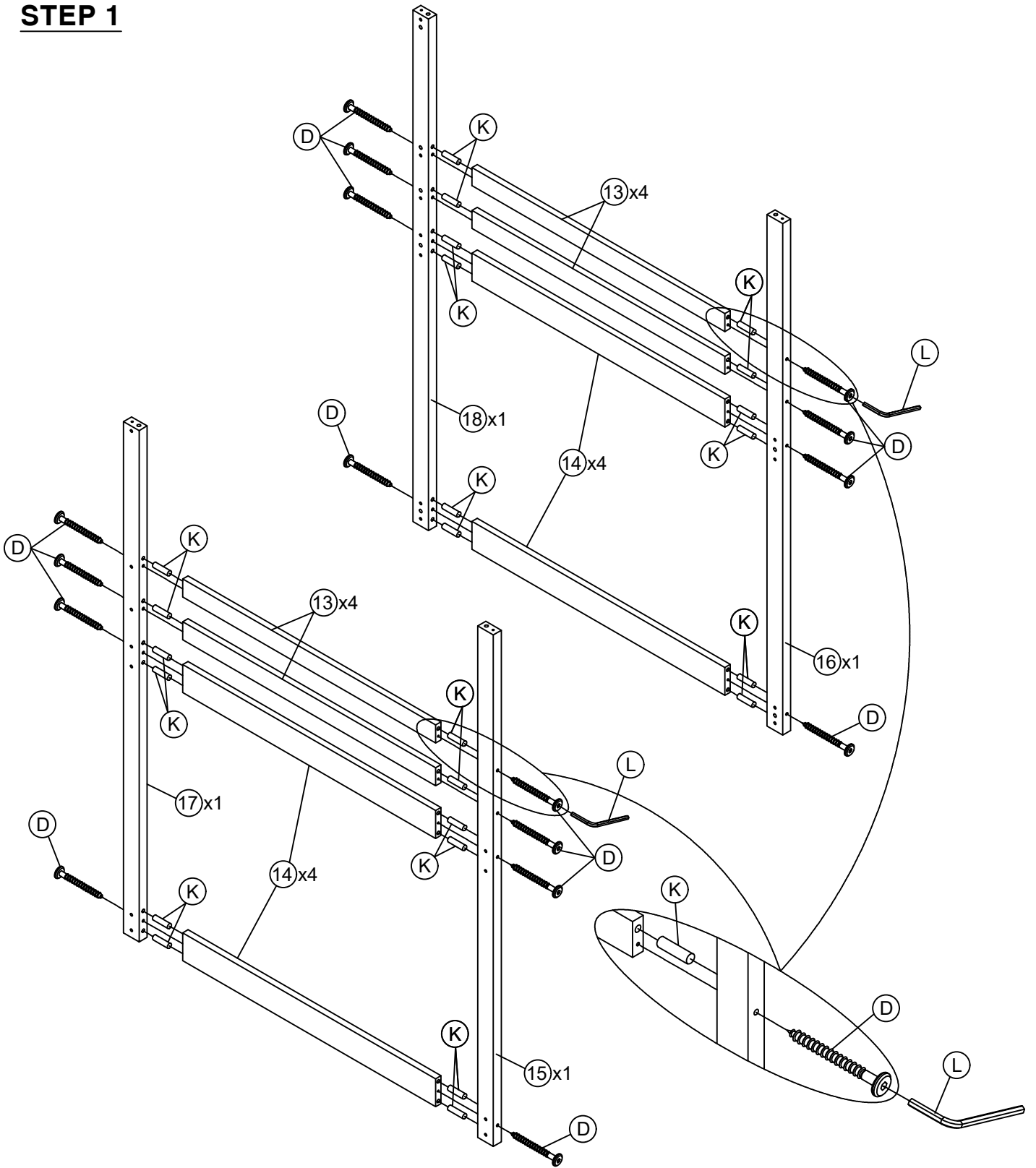
STEP 1





| | | | |
|----------|---------|---|-------|
| L | 4x58 |  | 1PC |
| K | Ø10x40 |  | 24PCS |
| D | 6.5x100 |  | 16PCS |

ASSEMBLY INSTRUCTIONS

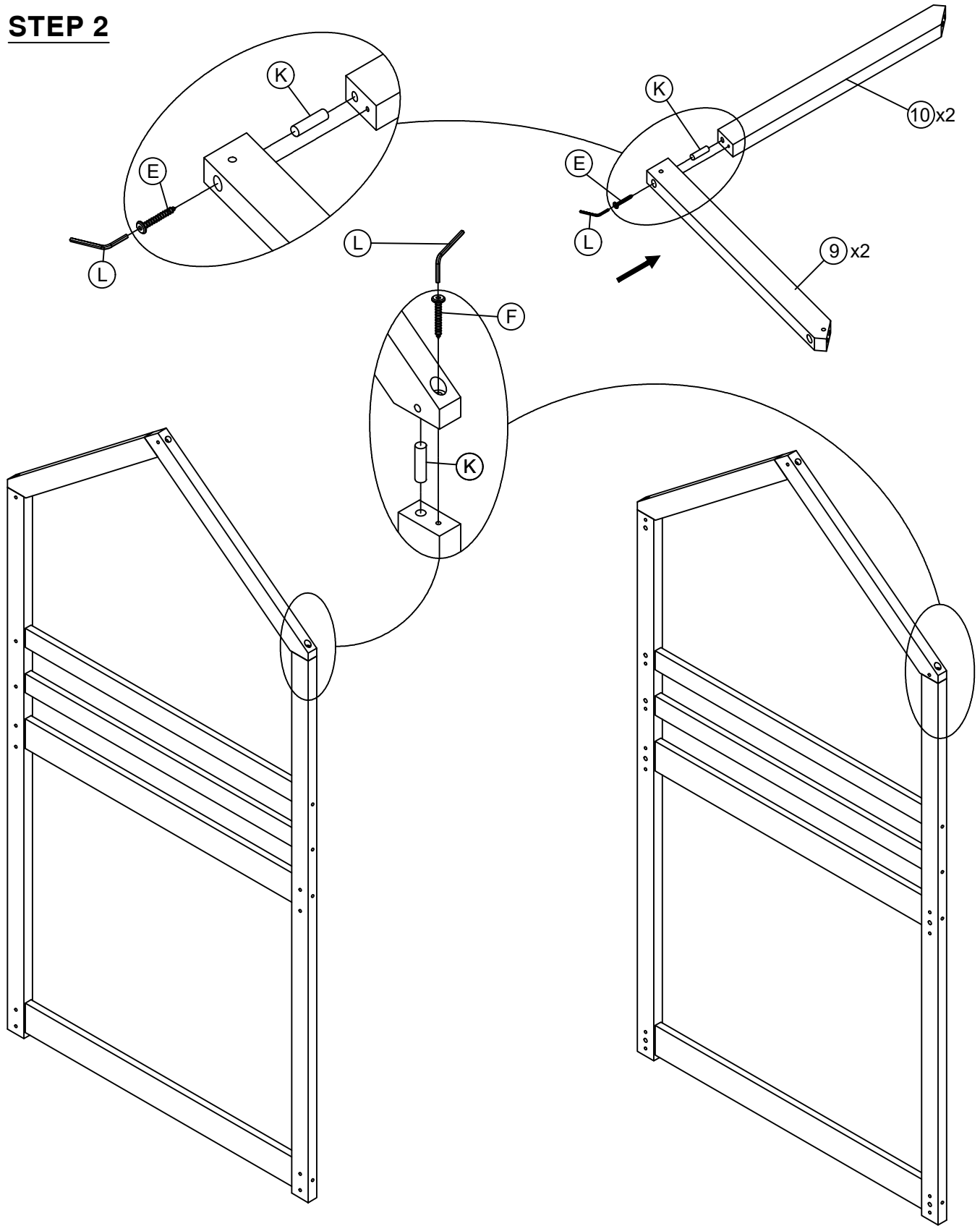
STEP 2

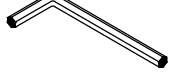



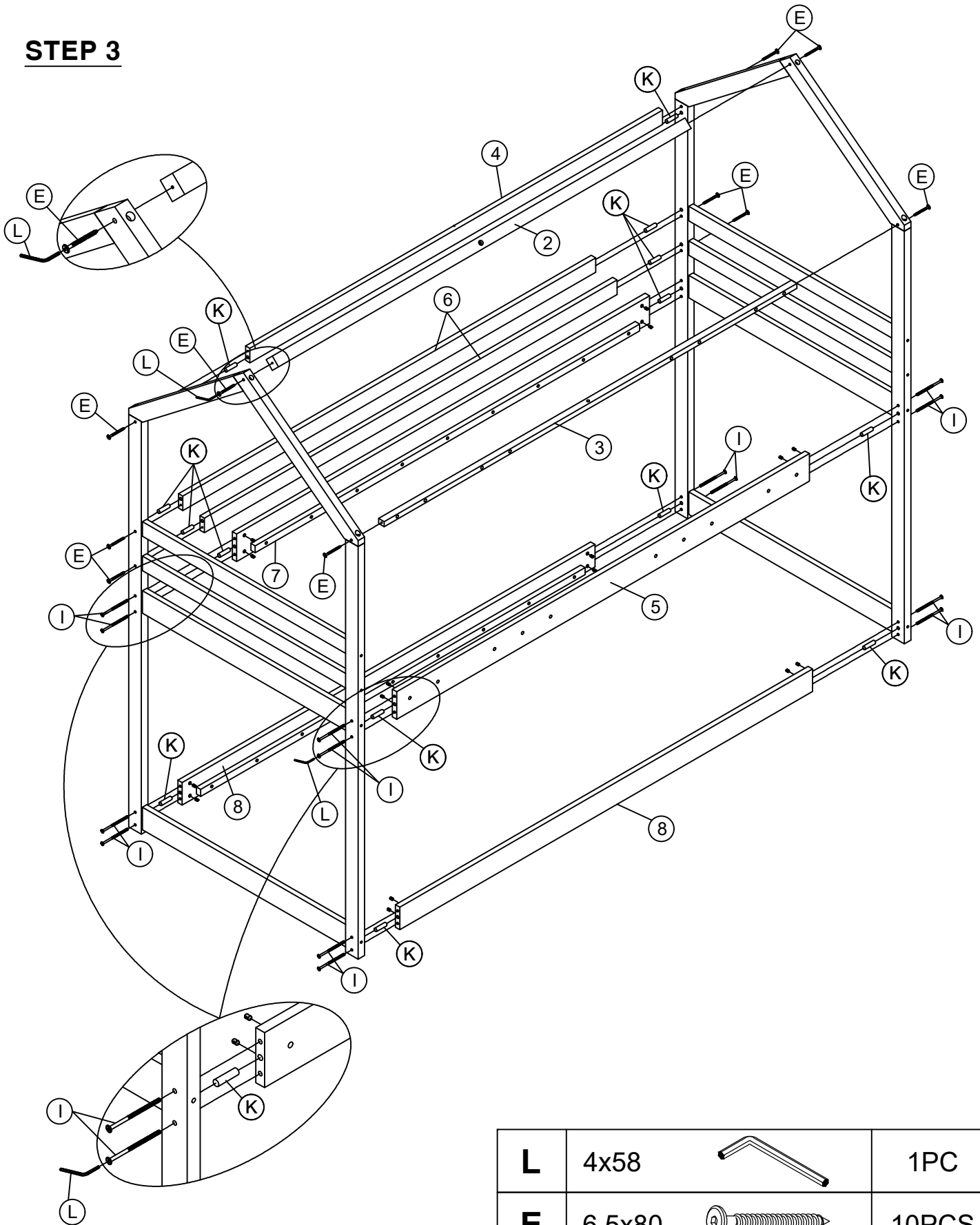

| | | | | | | | |
|----------|--------|---|------|----------|--------|---|------|
| F | 6.5x60 |  | 4PCS | L | 4x58 |  | 1PC |
| K | Ø10x40 |  | 6PCS | E | 6.5x80 |  | 2PCS |

ASSEMBLY INSTRUCTIONS

STEP 3





| | | | |
|----------|--------|---|-------|
| L | 4x58 |  | 1PC |
| E | 6.5x80 |  | 10PCS |
| K | Ø10x40 |  | 14PCS |
| I | 1/4x75 |   | 16PCS |

ASSEMBLY INSTRUCTIONS

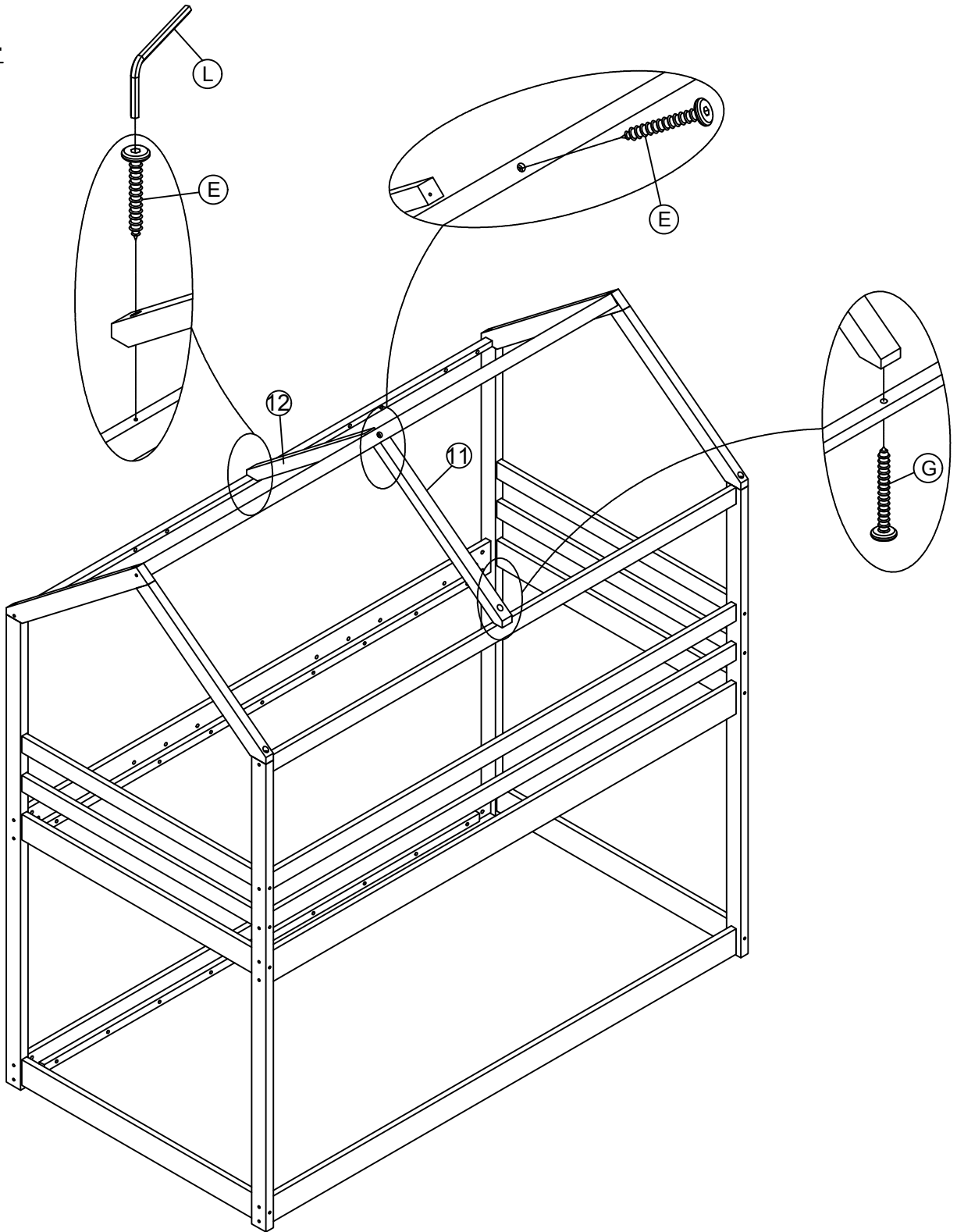
STEP 4



| | | | | | | | |
|----------|--------|---|------|----------|--------|---|-----|
| | | | | L | 4x58 |  | 1PC |
| E | 6.5x80 |  | 3PCS | G | 6.5x40 |  | 1PC |

ASSEMBLY INSTRUCTIONS

First attach 2pcs part 21 to the front and end of the frame between headboard. Then attach the remaining part 21 equidistantly between headboard

STEP 5

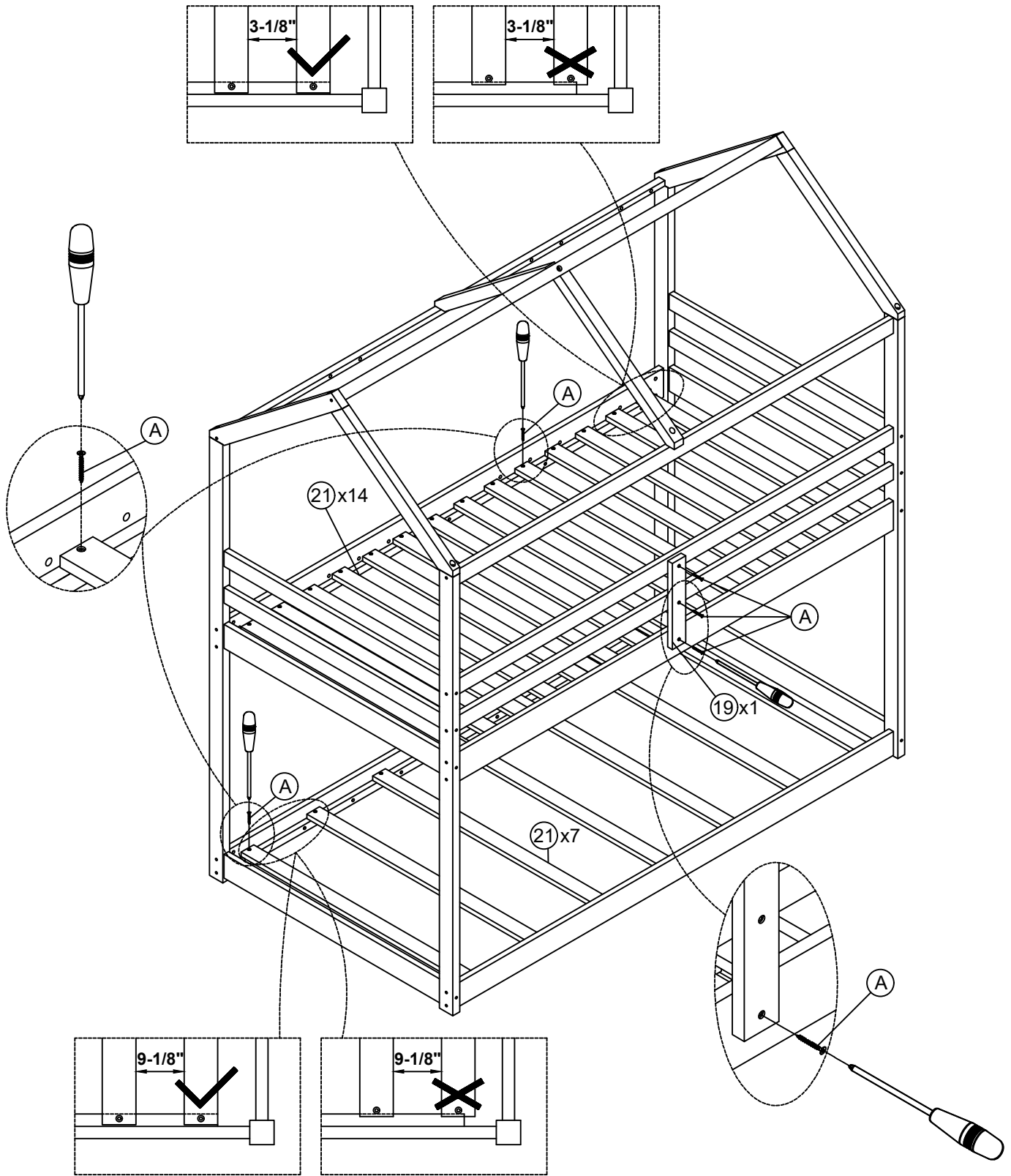

Note : Do not lock the screws of the bed slats to the outermost edge of the bed slats, you need to leave a certain space at the edges, otherwise it will cause the board to break

A

Ø4x30







45PCS

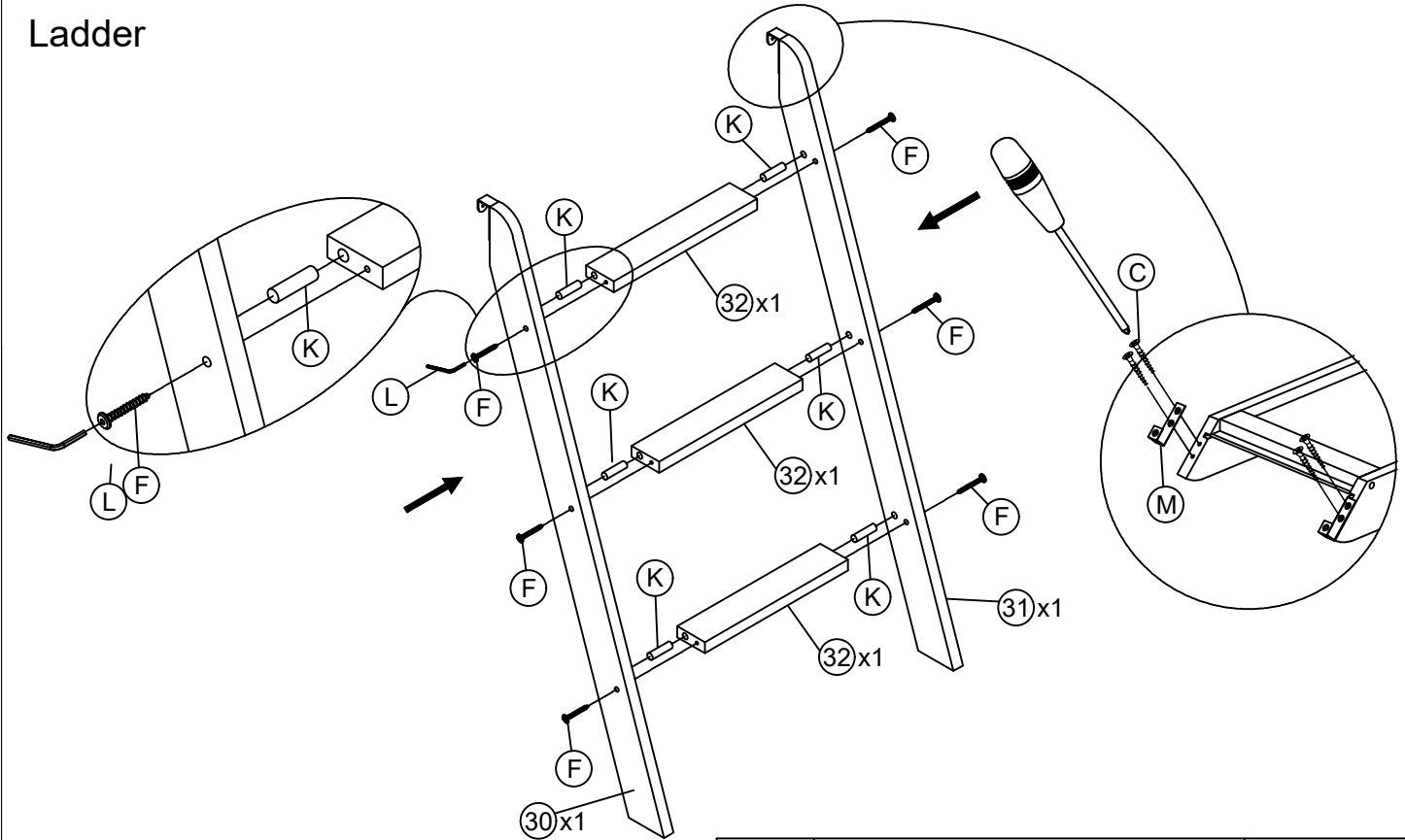

ASSEMBLY INSTRUCTIONS

STEP 6

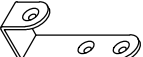
Ladder





| | | | |
|----------|---------|---|------|
| C | Ø4x15 |  | 4PCS |
| M | 70x18x2 |  | 2PCS |
| F | 6.5x60 |  | 6PCS |

| | | | |
|----------|--------|---|------|
| K | Ø10x40 |  | 6PCS |
| L | 4x58 |  | 1PC |

STEP 7

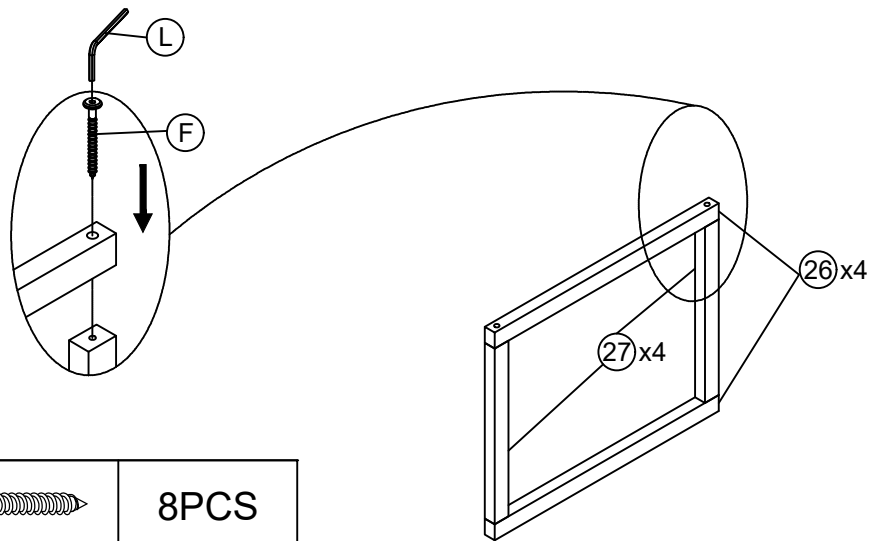
Window Frames





| | | | |
|----------|--------|---|------|
| F | 6.5x60 |  | 8PCS |
| L | 4x58 |  | 1PC |

ASSEMBLY INSTRUCTIONS

STEP 8

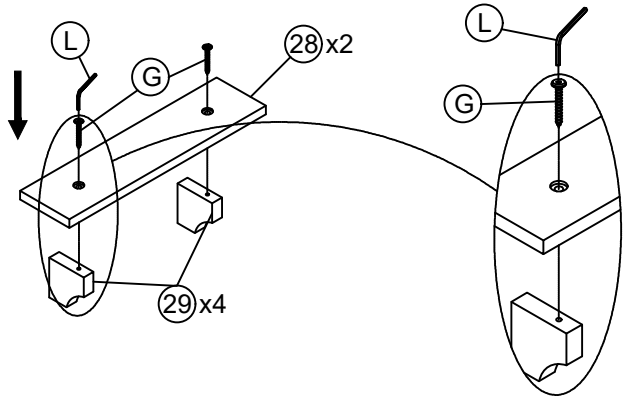
Window bar

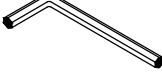

| | | | |
|----------|--------|---|------|
| G | 6.5x40 |  | 4PCS |
| L | 4x58 |  | 1PC |

STEP 9

Window bar

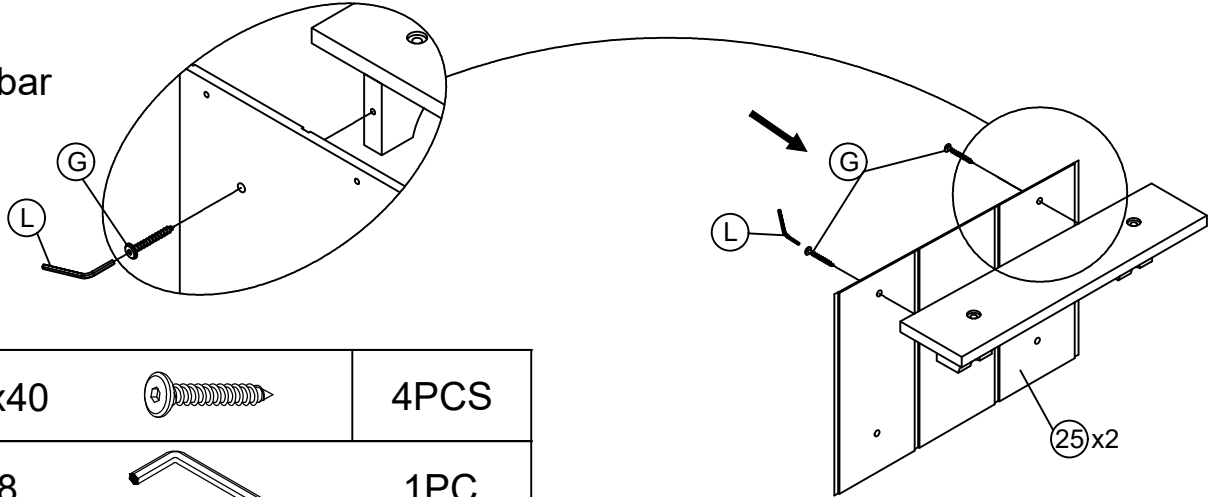

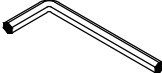
| | | | |
|----------|--------|---|------|
| G | 6.5x40 |  | 4PCS |
| L | 4x58 |  | 1PC |

STEP 10

Window

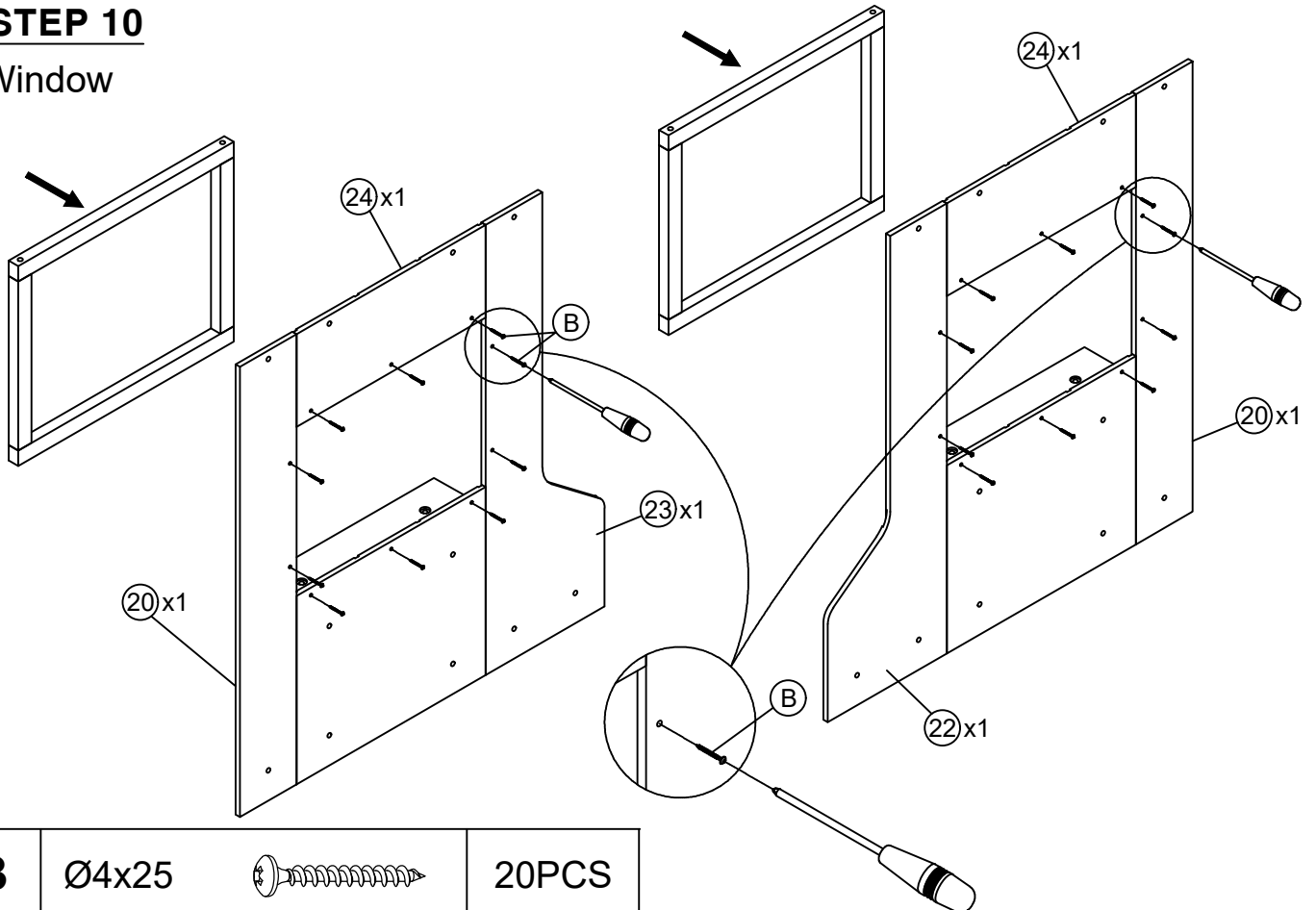



| | | | |
|----------|-------|---|-------|
| B | Ø4x25 |  | 20PCS |
|----------|-------|---|-------|

ASSEMBLY INSTRUCTIONS

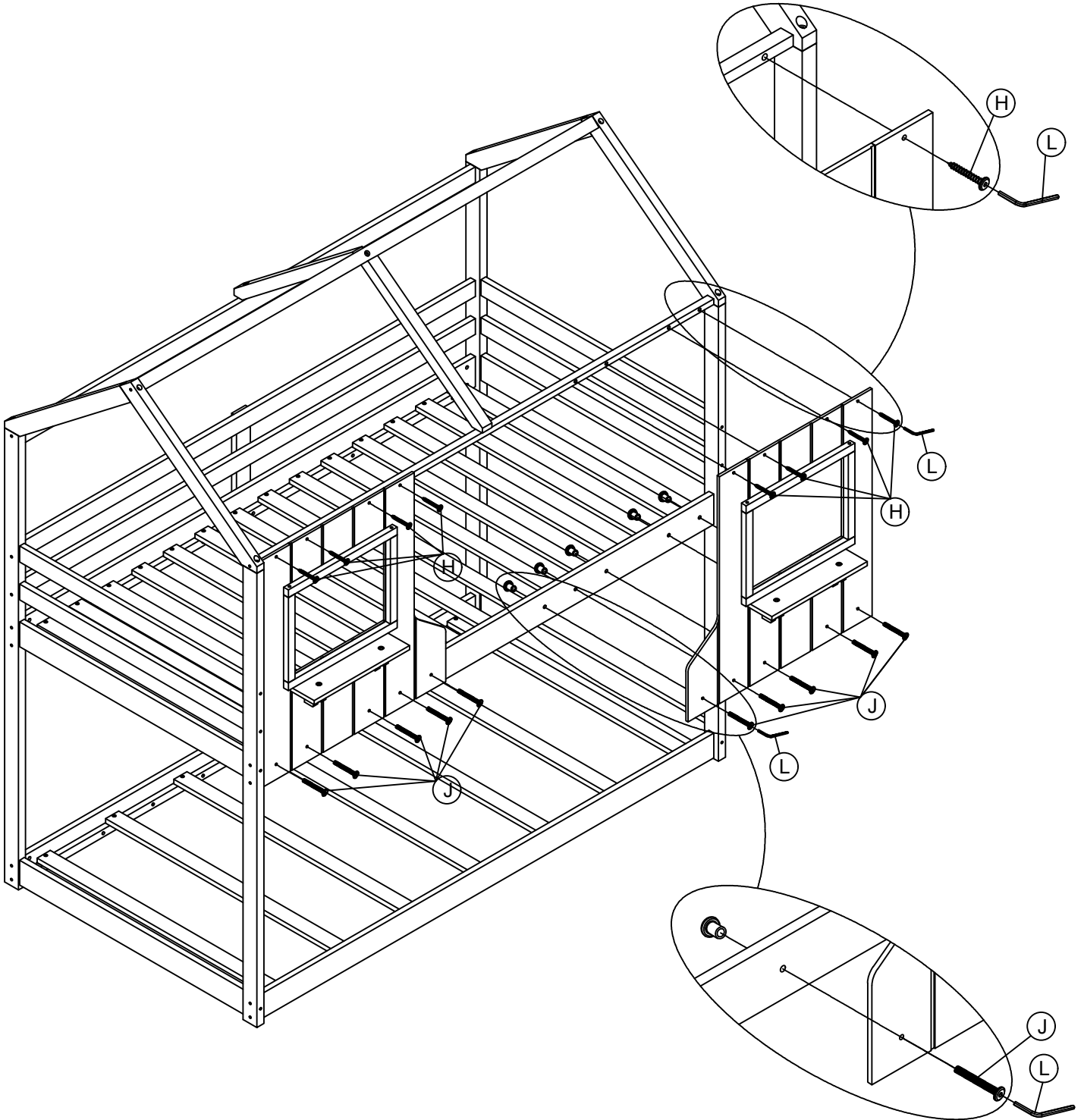
STEP 11

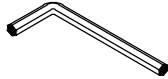

| | | | | |
|----------|--|-----|---|-------|
| L | 4x58  | 1PC | H 6.5x30  | 8PCS |
| | | | J 1/4x20  | 10PCS |

ASSEMBLY INSTRUCTIONS

STEP 12

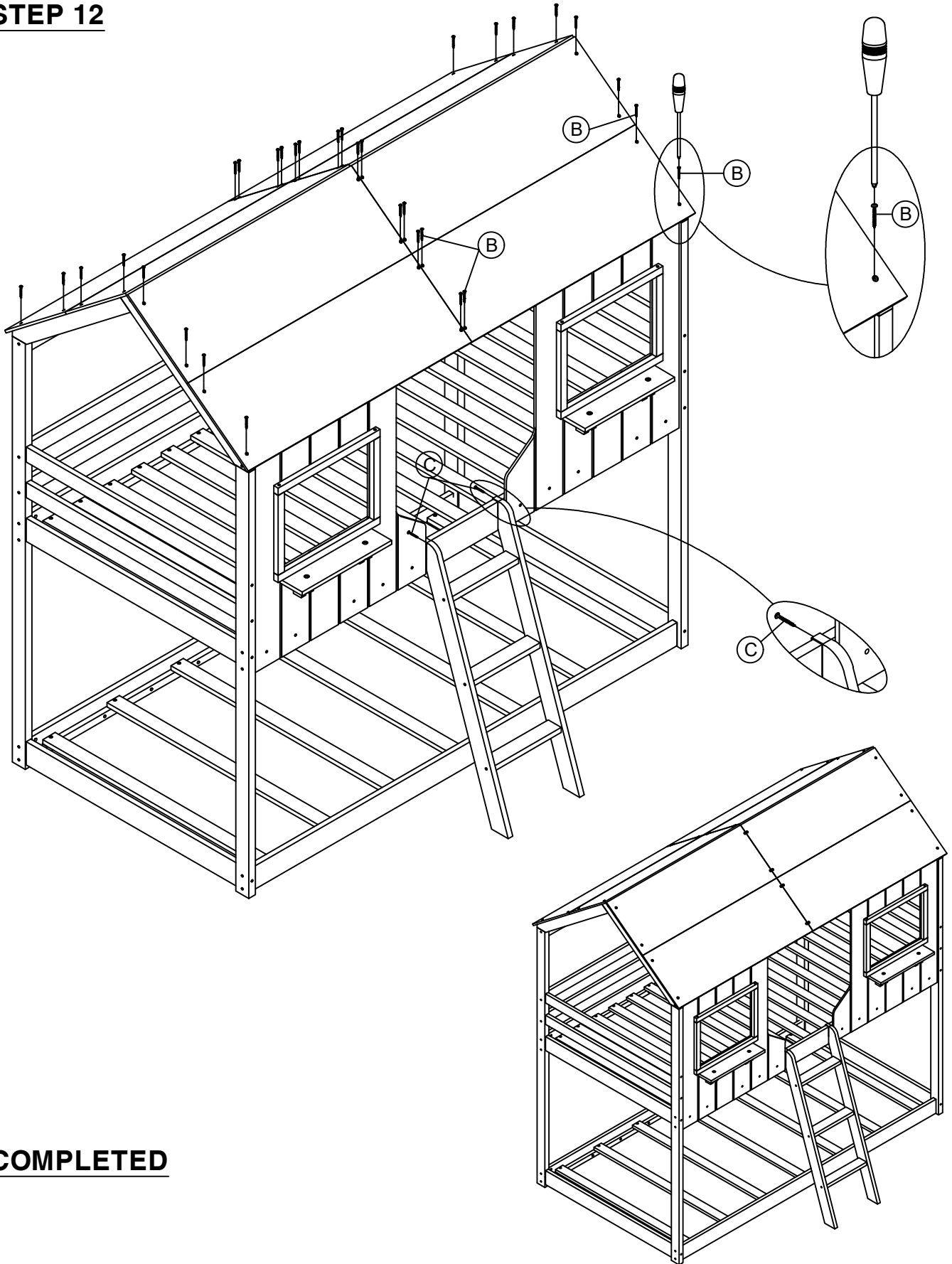

COMPLETED

B

Ø4x25



32PCS

C

Ø4x15



2PCS