

Top View

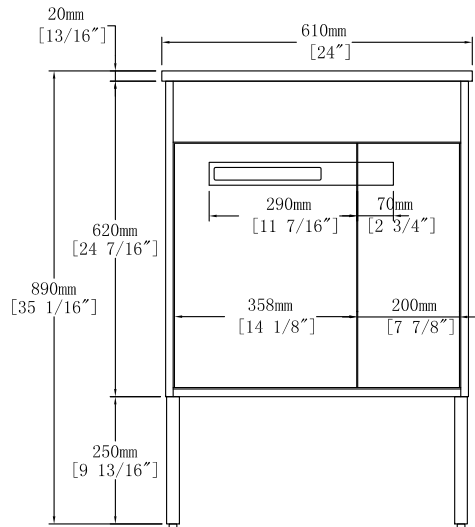

Front View

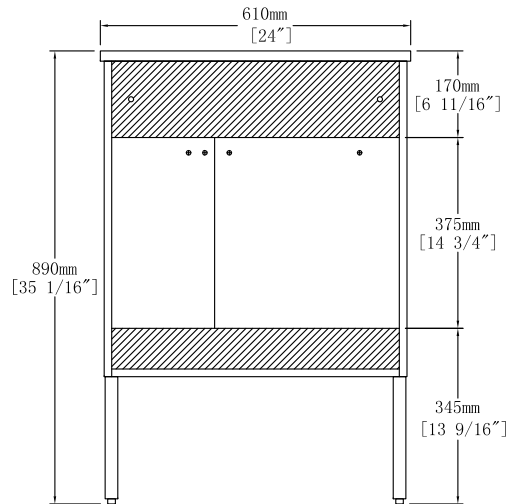

Back View

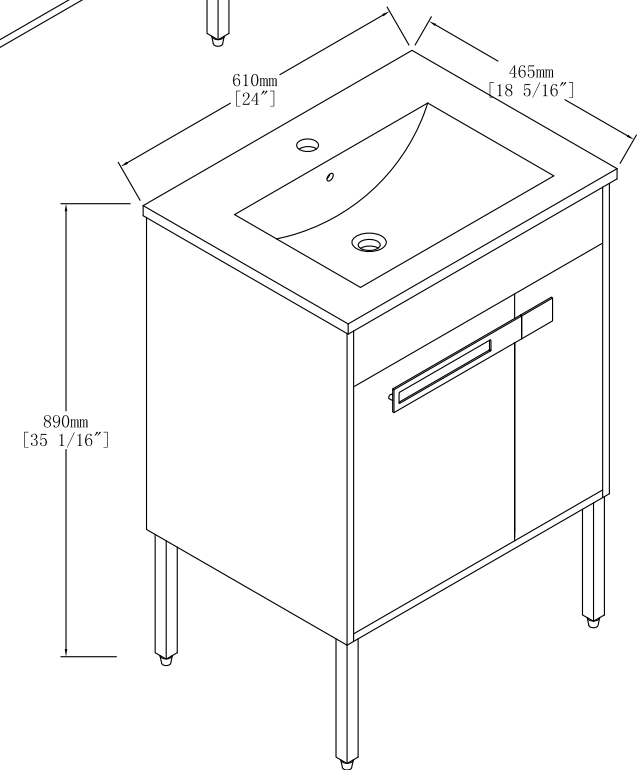
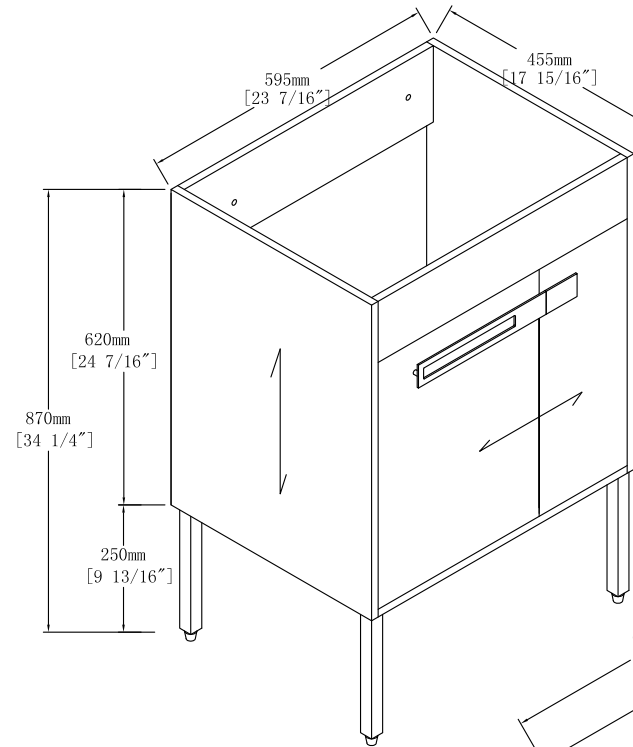

Item NO. BV B00324

Version V1

Projece

Date 2021-12-6