

**EN\_IMPORTANT, RETAIN FOR FUTURE REFERENCE: READ CAREFULLY.**

**FR\_IMPORTANT: A LIRE ATTENTIVEMENT ET À CONSERVER POUR CONSULTATION  
ULTÉRIEURE.**

**ES\_IMPORTANTE, LEA Y GUARDE PARA FUTURAS REFERENCIAS.**

**PT\_IMPORTANTE, RETER PARA REFERÊNCIA FUTURA: LEIA ATENTAMENTE.**

**DE\_WICHTIG! SORFGFÄLTIG LESEN UND FÜR SPÄTERES NACHSCHLAGEN AUFBEWAHREN.**

**IT\_IMPORTANTE! CONSERVARE IL PRESENTE MANUALE PER FUTURO RIFERIMENTO E  
LEggerlo ATTENTAMENTE.**

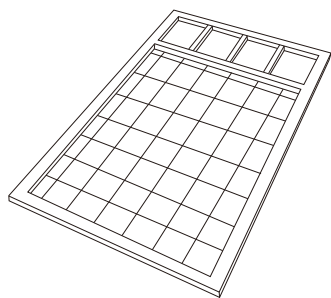

**A\*4**

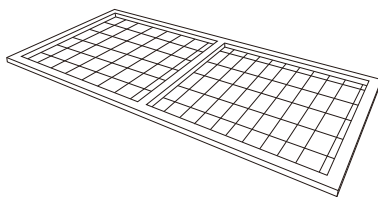

**B**

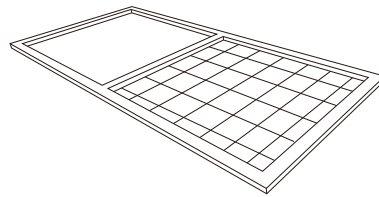

**C**

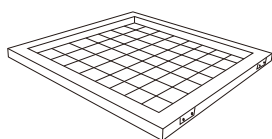

**D**

**10\*55cm**  
**3.94\*21.65inch**

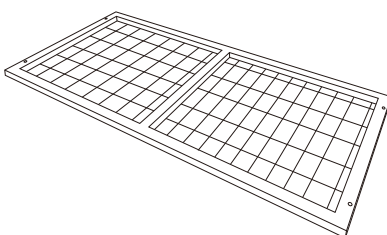

**E\*2**

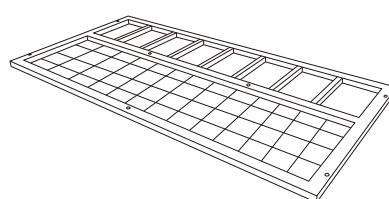

**F\*4**

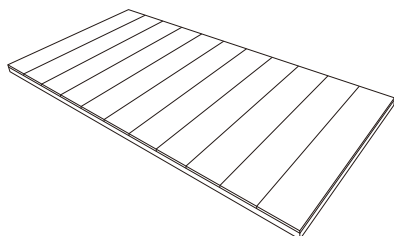

**G\*2**

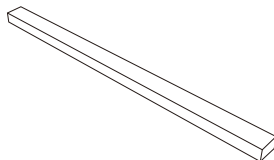

**H\*2**

**10\*52.5cm**  
**3.94\*20.67inch**

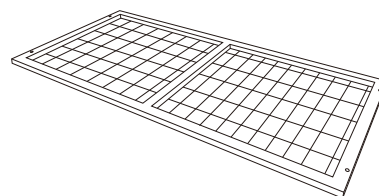

**I\*2**

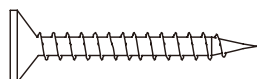

**3.5\*30 48+4PCS**

**S1**



**3.0\*15 32+3PCS**

**S2**



**2.5\*10 4PCS**

**S3**



**2.0\*10 8PCS**

**S4**



**8PCS**

**S5**



**1PC**

**S6**



**1PC**

**S7**

**A** x02

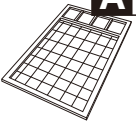

**B** x01

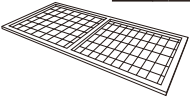

**S5** x04



**S2** x16



3.0\*15mm

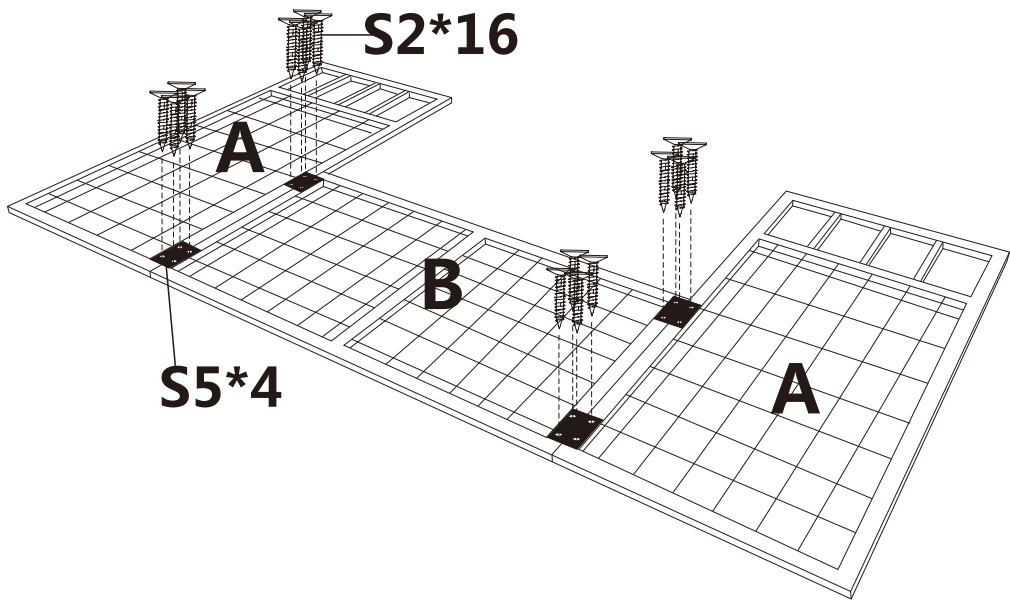

**C** x01

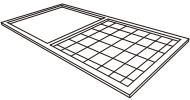

**D** x01

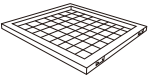

**S6** x01



**S7** x01



**S3** x04



2.5\*10mm

**S4** x08



2.0\*10mm

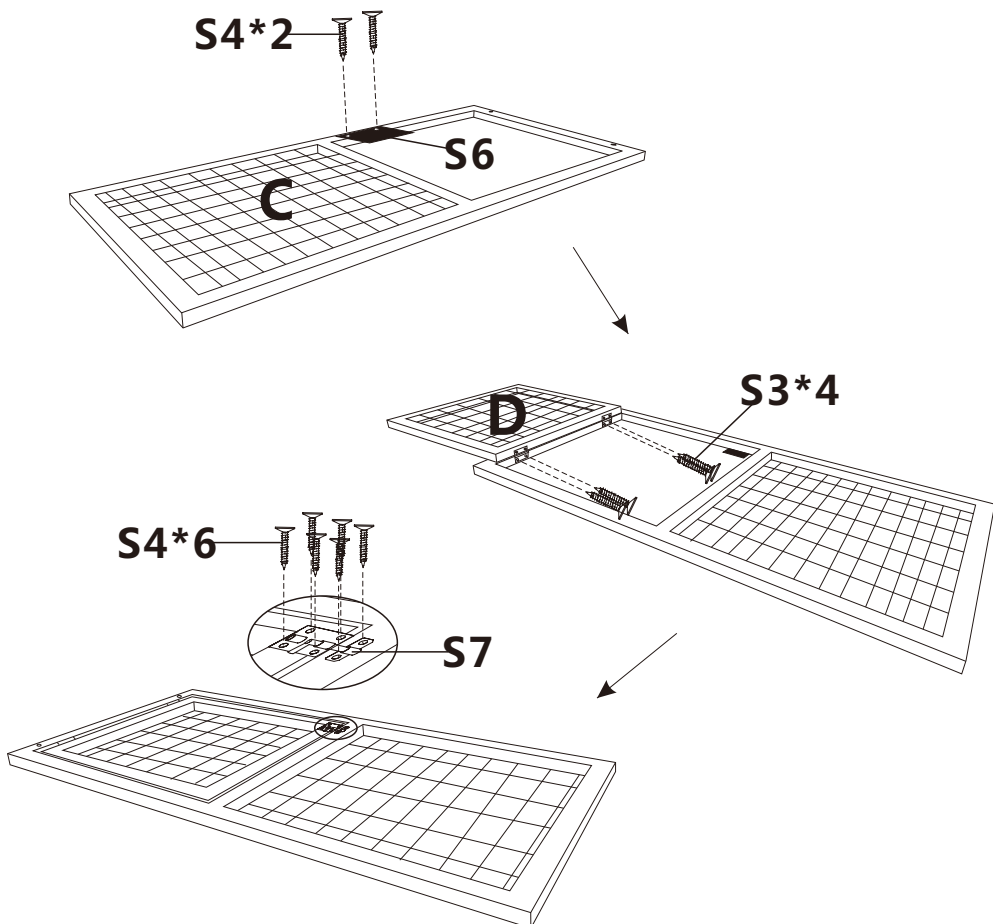

02



A x02

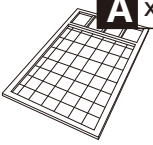

S5 x04



S2 x16



3.0\*15mm

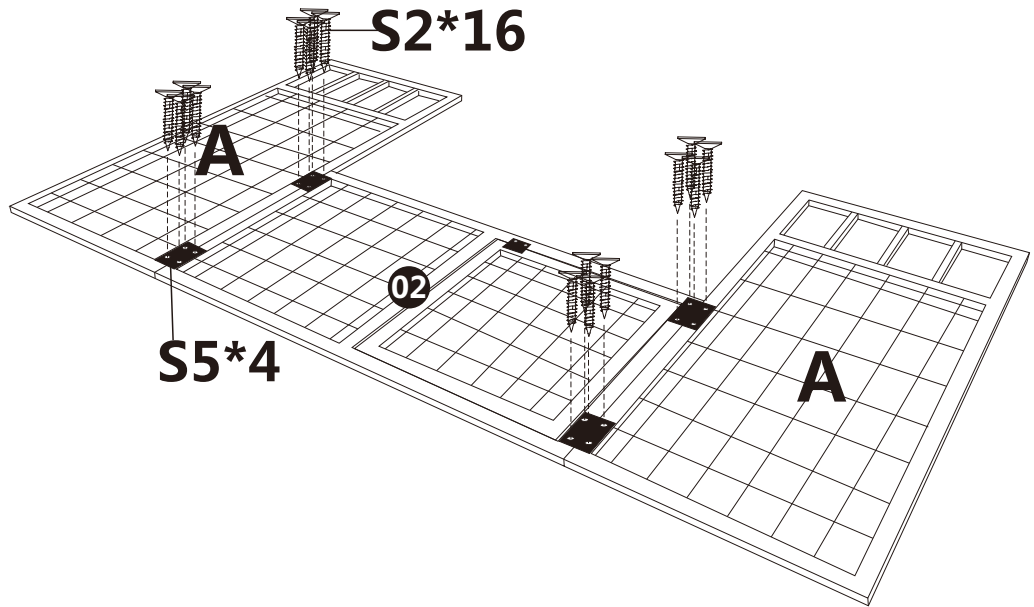

01

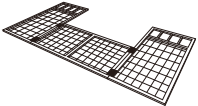

03

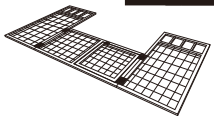

E x01

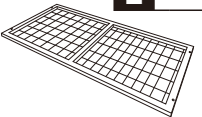

F x01

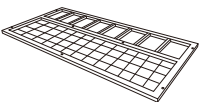

S1 x08



3.5\*30mm

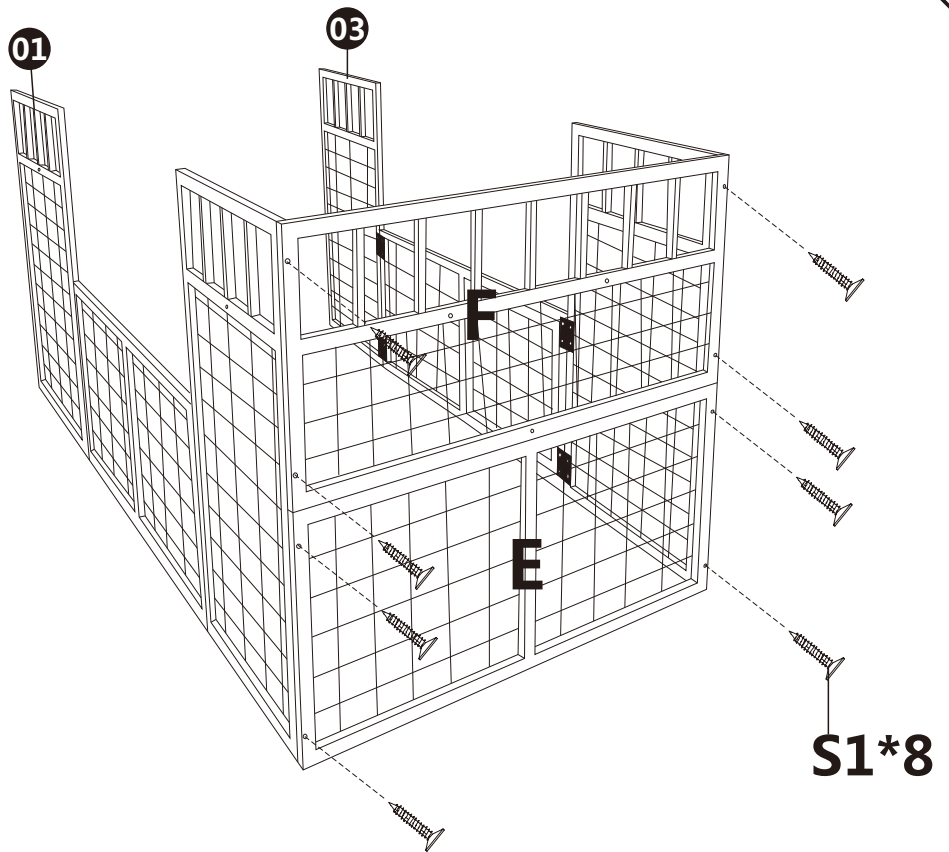

04



**E** x01

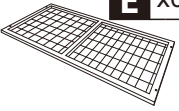

**F** x01

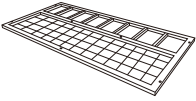

**S1**x08



3.5\*30mm

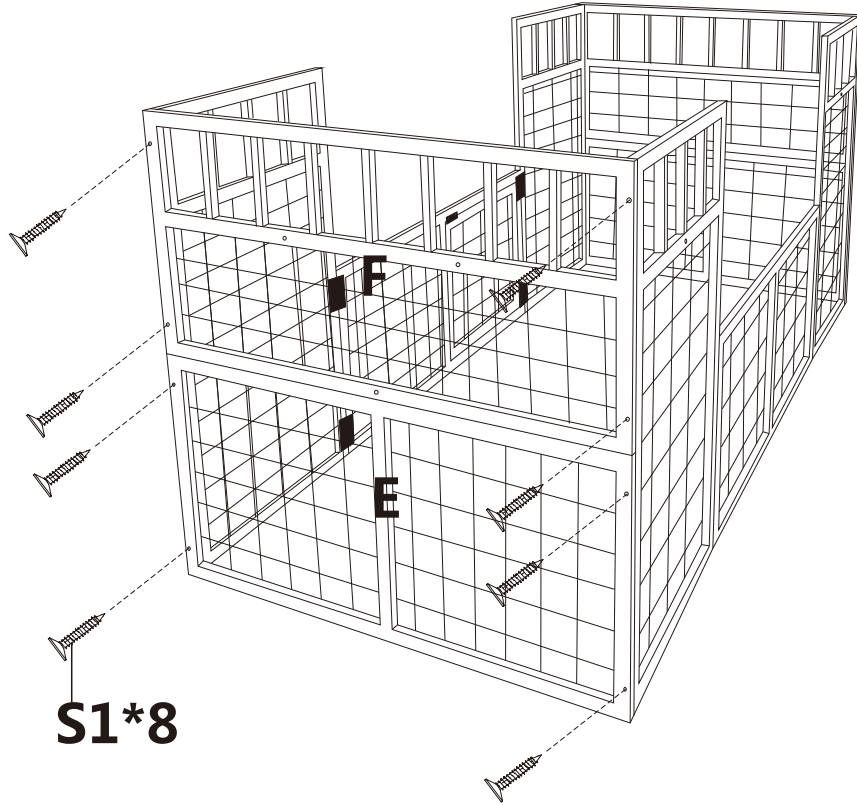

**S1\*8**

05



**G** x02



**S1**x08



3.5\*30mm

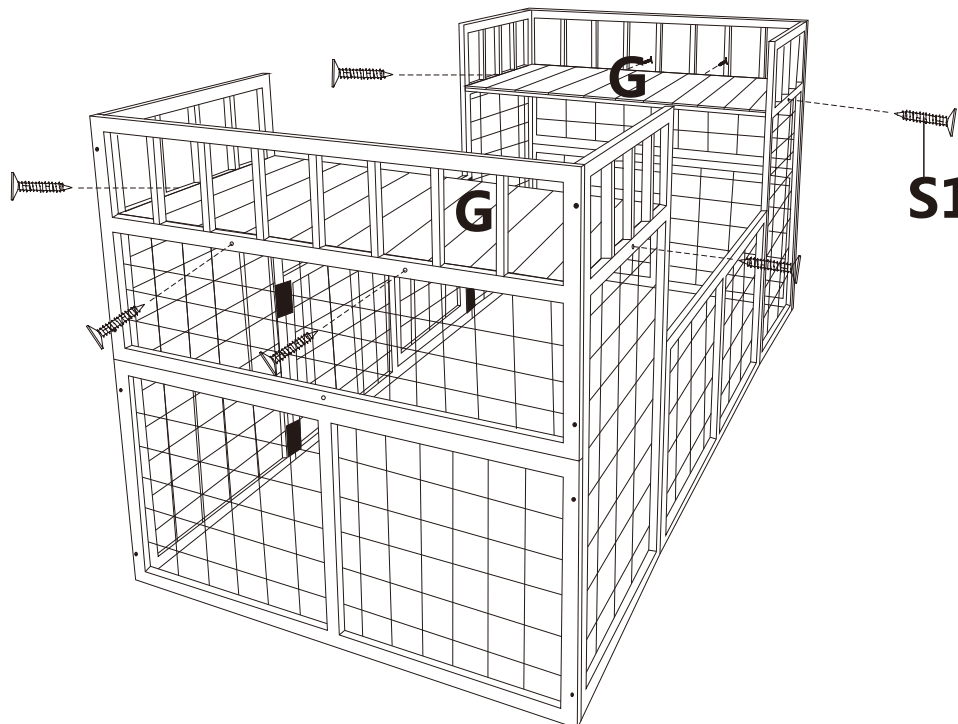

**S1\*8**

06



F x02

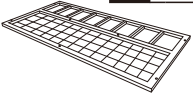

S1 x12



3.5\*30mm

S1\*12

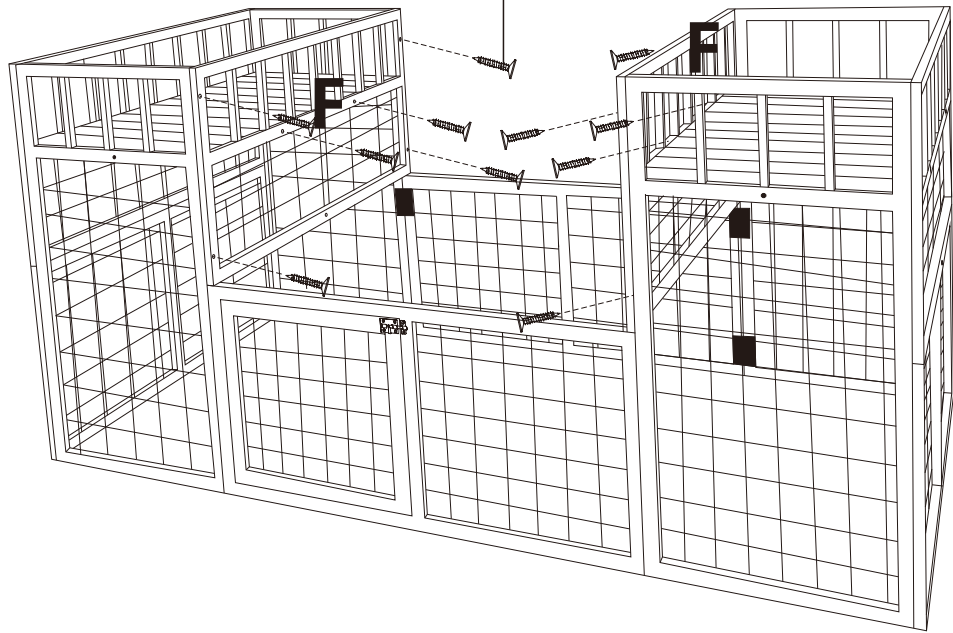

07



H x02



S1 x04



3.5\*30mm

S1\*4

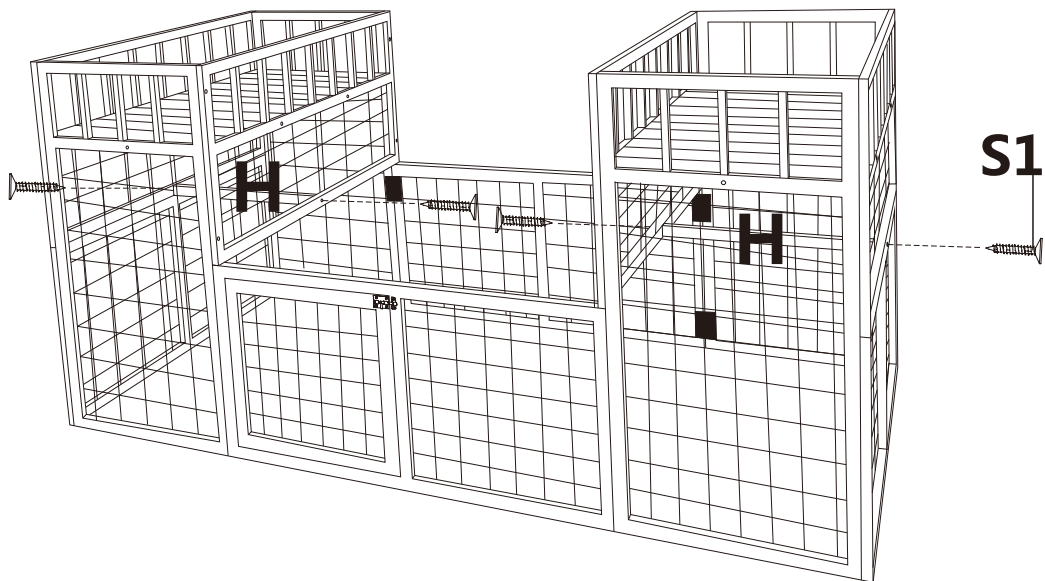

08



I x02

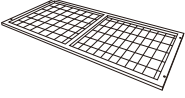

S1 x08



3.5\*30mm

S1\*8

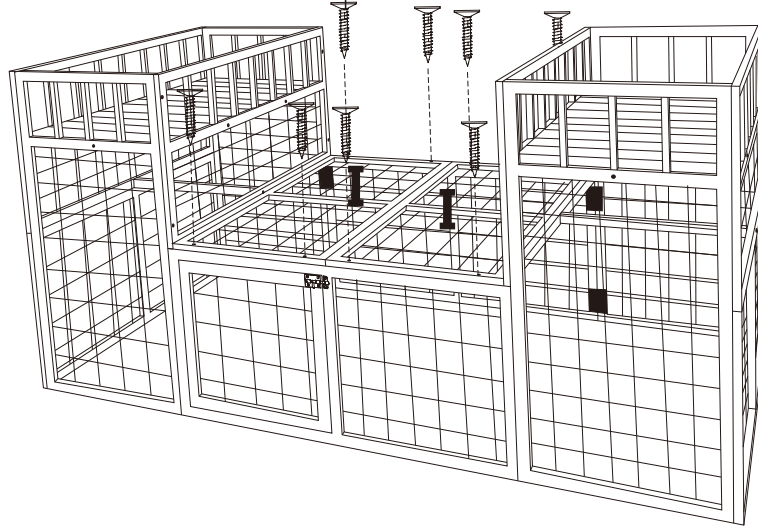

Done

