

## Duo Seat Instructions

















Congratulations on your new purchase. Before assembly please refer to the parts list below to ensure all parts are correct.

**Please retain for future use.**

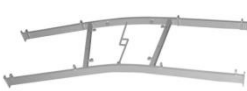
### Warnings:

This product is not for commercial use  
Keep children away during assembly. This item contains small parts which can be swallowed by children.

### Parts List:

	A	2PCS		C	2PCS		E	4PCS		H	1PC		K	8PCS		O	8PCS
							F	1PC		I	1PC		L	4PCS		P	6PCS
	B	1PC		D	2PC		G	4PCS		J	1PC		M	32PCS		N	4PCS

### Assembly Guide

Please follow the diagram shown in section I. Please assemble both bar D or E across frame A. Please adjust and ensure the length of bar D and E can be initially fitted to frame A before assembly, the following the below instruction:

- i) Please insert the short side of the Allen Key (Part J) into the hole located in the middle of the bar.
- ii) Make approx. half a turn in a clockwise position, and remove the Allen Key from the hole.
- iii) Repeat step i) and ii) until the bar has been extended to a tight position.
- iv) Repeat step i) and ii) however in a counter-clockwise position when disassembling part D.

Both seat frames then should be assembled onto frame B. Please find the diagram in section I for the screw locations on frame B.

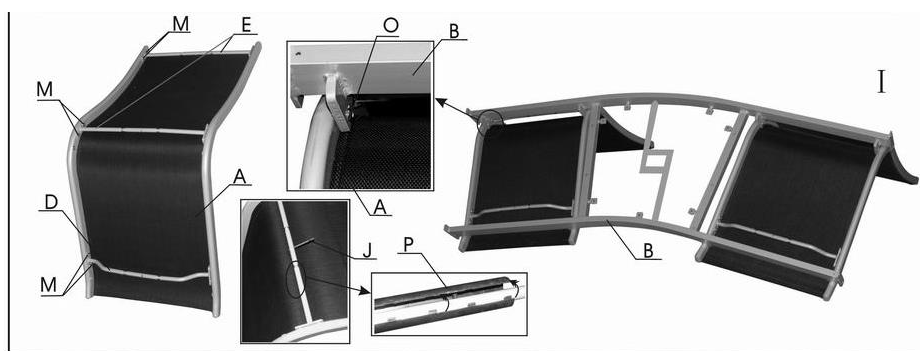

Two pieces of frame C are to be secured in both side of frame B. Please locate the screw locations in the diagram below.

Please connect all four pieces of part G onto part F using screw M. Then this glass frame is to be connected onto part B using screw L. (Please refer to the diagram for the location of the screw).

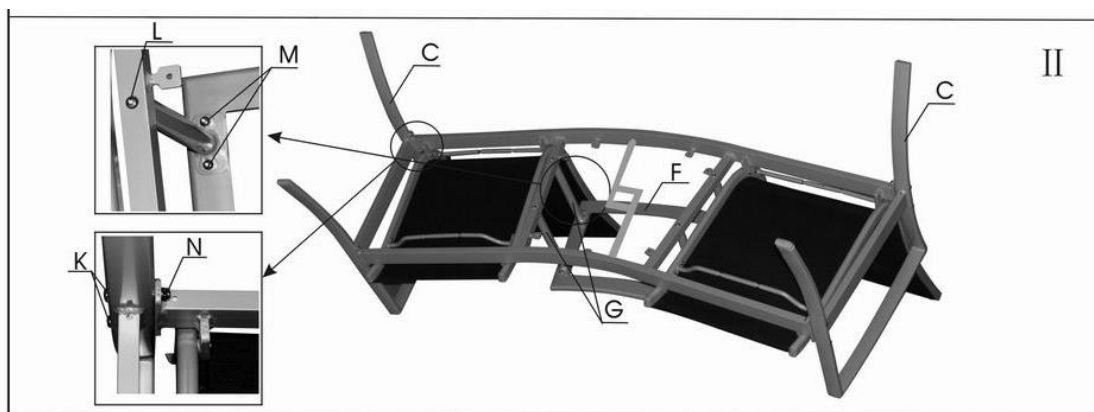

Place the completed frame in a correct position shown in bottom of the picture below. Please place the glass top H onto to top part of the glass frame and glass top I onto to bottom part of the glass frame. Ensure the glass tops are placed carefully and rigidly onto the frame. Please re-check all the screws to ensure they are the correct type and secured tightly to all parts.



## **Spare Parts**

Please note we stock the below spare parts should they be missing from your item on receipt. If the item has a major fault or fundamental flaw please return to the place of purchase.

Part D	
Part E	
Part G	
Part K	
Part L	
Part M	
Part O	
Part P	