

**TOOLS REQUIRED**

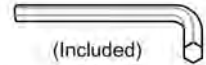

Screwdriver  
( Not included)



(Included)  
Allen Wrench



2 - People

**ASSEMBLY RATING**

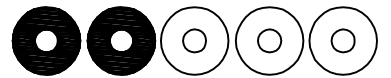

EASY —————> DIFFICULT

The Assembly Rating is a 5-point system showing the level of effort needed to assemble a specific product.

# PRE ASSEMBLY INTRODUCTION

We understand building ready-to-assemble furniture can be a challenging experience for some. To help avoid confusion, we have provided some helpful tips that may speed up the process.



## Teamwork

ALWAYS have at least two people to help with transporting and assembling the product to avoid potential injury and/or damage.



## Suitable Location

Assembling near the area of the intended location is highly recommended.



## Sufficient Space

Make sure you have enough space to move around during the assembly.



## Avoid Scratches

Use cardboard, blankets or a carpeted area while assembling furniture to prevent to prevent scratches and damages.

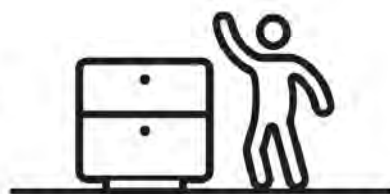

## Flat Surface

Make sure the furniture rests on a flat and level surface with each leg evenly touching the floor.

# ASSEMBLY AND CARE ADVICE



**FAILURE TO FOLLOW THE GUIDELINES BELOW MAY RESULT IN INJURY AND/OR PROPERTY DAMAGE.**



Position each part correctly and insert screws or bolts into their respective holes.



Turn clockwise to tighten and only tighten when step is completed or when instructed to do so.



Use the appropriate hand tools or power tools for assembly. Select steps, such as tightening screws and/or bolts, may require hand tools to avoid causing damage during assembly.



Save the instructions and store any supplied tools for later maintenance.



After two weeks, check and tighten any loose hardware and repeat again every six months thereafter.

**IT IS THE USER'S RESPONSIBILITY TO MAINTAIN THE FURNITURE. THE HARDWARE MAY LOOSEN OVER TIME AND MAY CAUSE THE FURNITURE TO BE WOBBLY AND UNABLE TO SUPPORT ITS INTENDED WEIGHT CAPACITY. THIS MAY LEAD TO COLLAPSE AND MAY CAUSE SERIOUS INJURY.**

# DRESSER & MIRROR



- Please keep instructions for future reference.
- Check the quantity and irregularity of parts and hardware before you start.

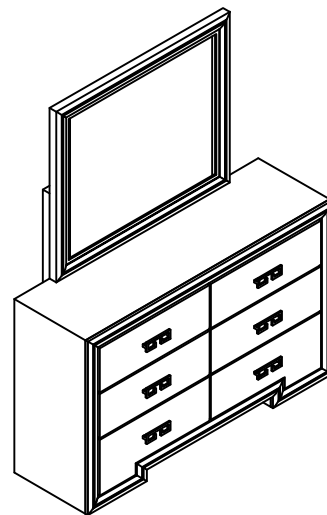

## PARTS

#1

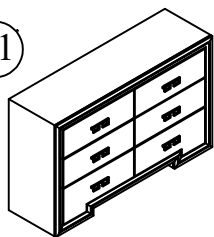

Dresser  
1 pc

#2

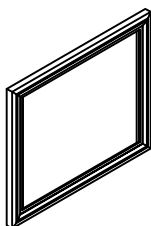

Mirror  
1 pc

#3

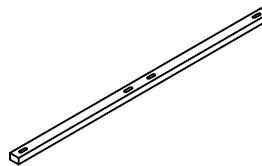

Back Rail  
2 pcs

## HARDWARE

#A



Bolt  $\text{Ø}1/4'' \times 1-1/2''$   
8 pcs

#B



Lock Washer  $\text{Ø}1/4''$   
8 pcs

#C

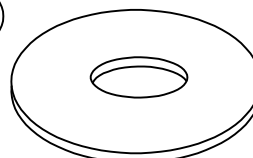

Flat Washer  $\text{Ø}1/4''$   
8 pcs

#D

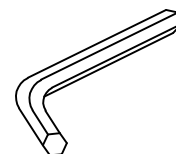



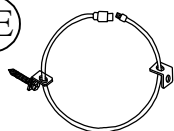

Allen Wrench 4mm  
1 pc

#E

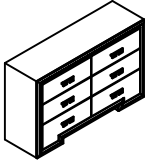
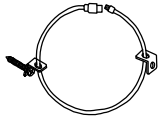
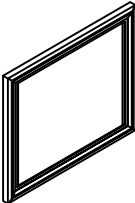
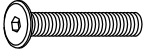

Anti-tip Kit  
1 Set

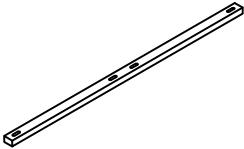
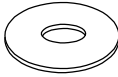
# packed in 2 cases

Carton	Designation	Part		Hardware
FM7440WH-D	Dresser	#1		 #E x1 pc
FM7440WH-M	Mirror	#2		 #Ax8 pcs  #B x8 pcs
	Back Rail	#3		 #C x8 pcs  #D x1 pc

