

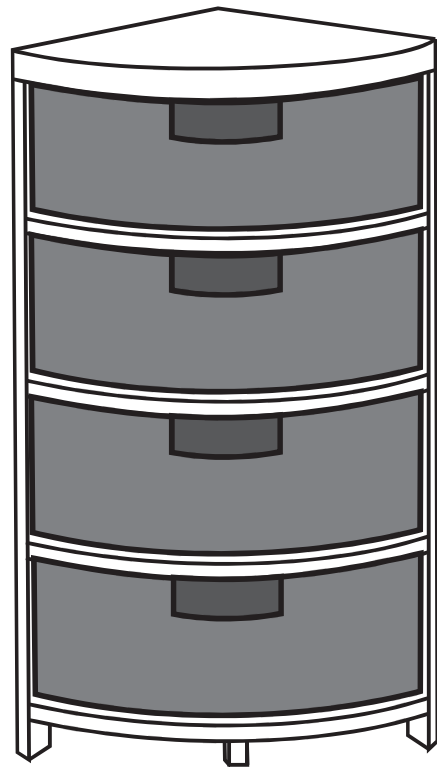

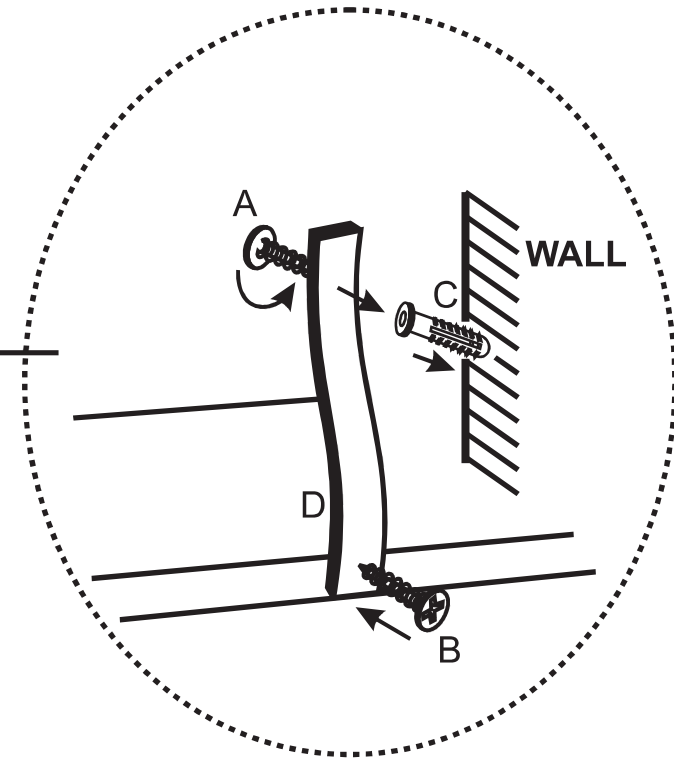

ANTI TIP KIT INSTRUCTION

① FRONT SIDE

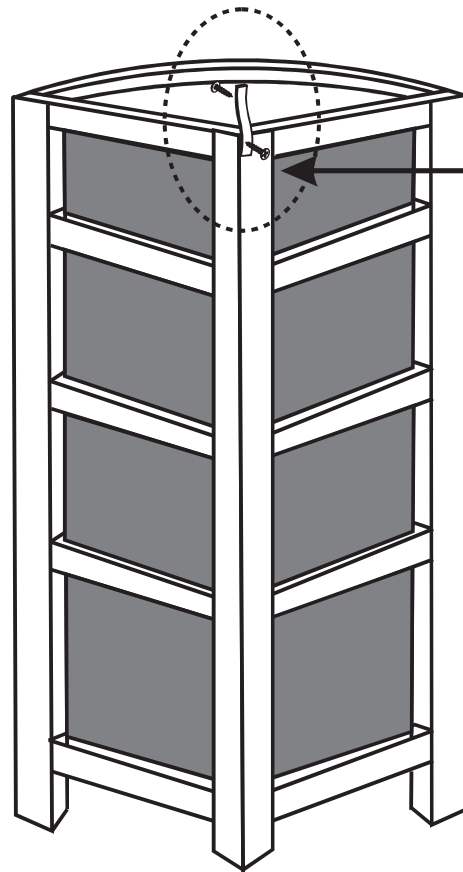

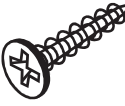
② BACK SIDE

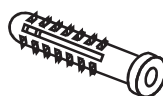

<p>A</p>  <p>1PC</p>	<p>B</p>  <p>1PC</p>	<p>C</p>  <p>1PC</p>	<p>D</p>  <p>1PC</p>
-----------------------------------------------------------------------------------------------------------	-----------------------------------------------------------------------------------------------------------	-----------------------------------------------------------------------------------------------------------	-----------------------------------------------------------------------------------------------------------