

MID-CENTURY MODERN

AIR HOCKEY



Warning

Adult Assembly Required

Asamblea de adultos de advertencia necesaria



MODEL # / No. de Mid-Century Modern

#26-3555

Assembly and Instructions/Asamblea e Instrucciones

Congratulations!

We hope you will have many hours of enjoyable use with your new Air Hockey Table!



PLEASE KEEP YOUR INSTRUCTIONS!

- Your Model number is necessary should you need to contact us.
- Please read through this instruction book to familiarize yourself with all the parts and assembly steps.
- Refer to the Parts Identifier and verify that all parts have been included.



WARNING!

This is not a child's toy. Adult supervision is required for children playing this game. Please read instructions carefully. Proper use of this set can avoid damage or injury.



BEFORE ASSEMBLY:

- Did you receive 1 box?
- Did you inspect your playfield/main table frame before assembly? It is not replaceable and must be returned to the original place of purchase if damaged.



TOOLS REQUIRED FOR ASSEMBLY:





- Phillips and Slotted Head Screwdrivers / or Power Driver (not included)
- Allen Wrench (included)

ASSEMBLY INSTRUCTIONS:

We recommend that two adults work together to assemble this table.

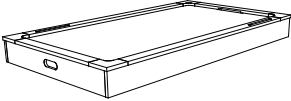
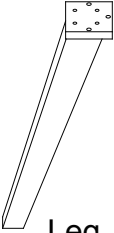
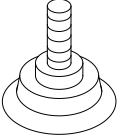
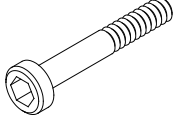
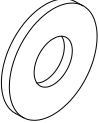
- The table will be assembled upside down. This is a very heavy table and turning it right side up will require at least two strong adults.
- We suggest that you use the bottom carton as a clean flat work area to protect the top of your Air Hockey table while assembling.

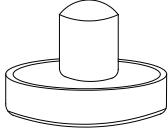
Parts List

<p>#1</p>  <p>Main Cabinet 1 piece</p>	<p>#2</p>  <p>Leg 4 pieces</p>	<p>#3</p>  <p>Leg leveler 4 pieces</p>	<p>#4</p>  <p>5/16"x1-1/2" Bolt 12 pieces</p>
<p>#5</p>  <p>5/16" Washer 12 pieces</p>	<p>#6</p>  <p>Puck 4 pieces</p>	<p>#7</p>  <p>Pusher 4 pieces</p>	<p>#8</p>  <p>Allen key 1 piece</p>

Step 1:

Attach #2 into #1 main cabinet, tight with #5 washer and #4 bolt.

Then screw in #3 leg levelers.

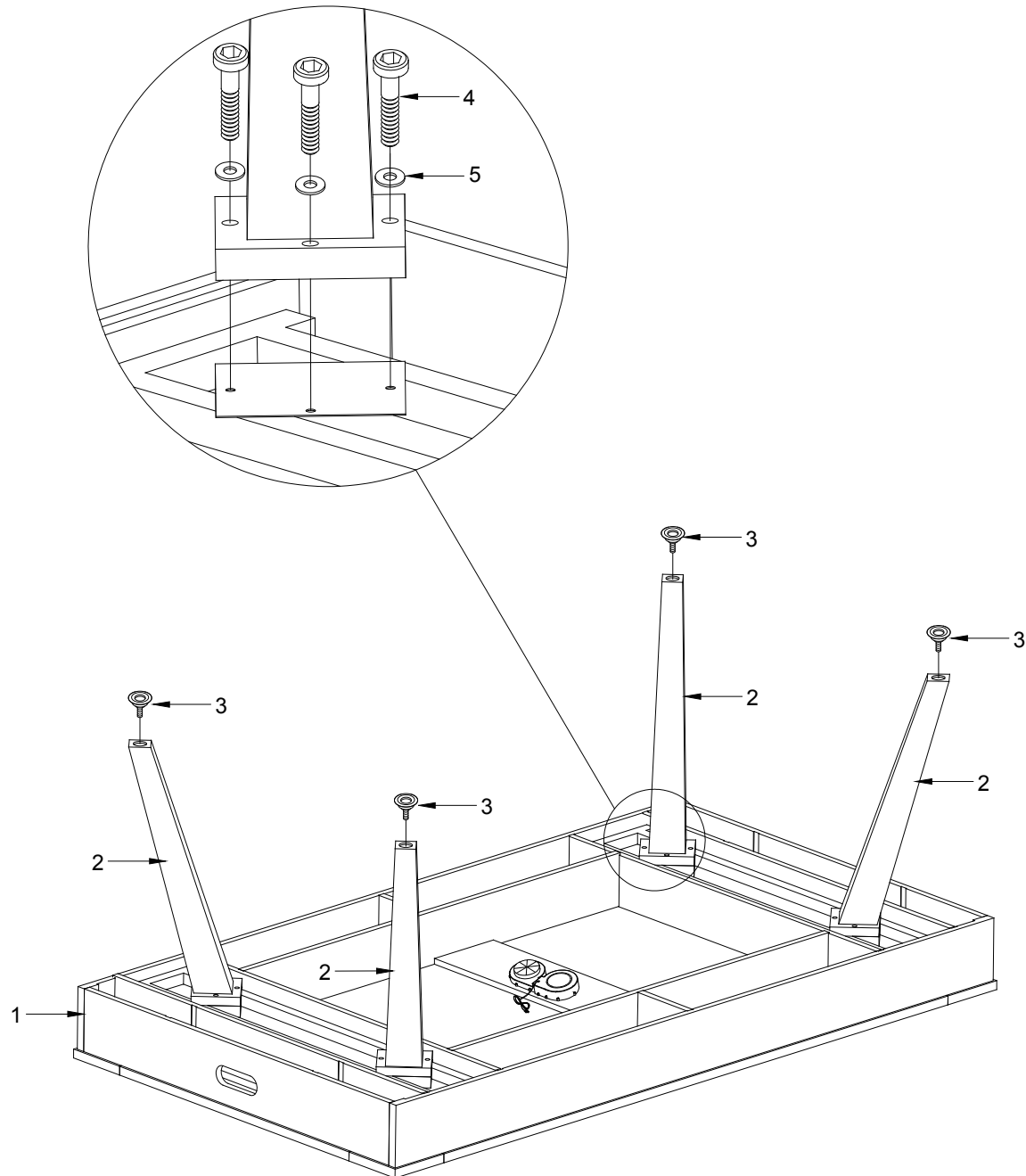

Step 2:

Using two strong adults turn the table right side up, then assembly is complete.

